



BURNSIDE

[THE DIFFERENCE IS OUR PEOPLE]

Appendix V

Transportation Systems Technical Report #3

Accessible formats and communication supports are available upon request:

York Region Transportation, Public Works

Phone: 1-877-464-9675 ext. 75000

TTY: 1-866-512-6228

Email: Transportation@york.ca



BURNSIDE

**Transportation System Technical
Report #3**

**Warden Avenue and Kennedy Road
Class Environmental Assessment**

York Region



BURNSIDE

Transportation System Technical Report #3

Warden Avenue and Kennedy Road Class Environmental Assessment

York Region

**R.J. Burnside & Associates Limited
6990 Creditview Road, Unit 2
Mississauga ON L5N 8R9 CANADA**

**August 2023
30052314.0000**

Transportation System Technical Report #3
 Warden Avenue and Kennedy Road Class Environmental Assessment
 August 2023

Distribution List

No. of Hard Copies	PDF	Email	Organization Name
0	Yes	Yes	York Region

Record of Revisions

Revision	Date	Description
0	Jan. 2, 2023	Initial submission to York Region
1	Apl 7, 2023	Second submission to York Region
2	Aug 24, 2023	Third submission to York Region

R.J. Burnside & Associates Limited

Report Prepared By:

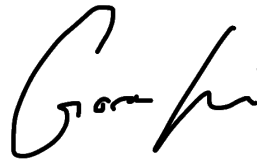

Gordon Hui, P.Eng.
 Senior Transportation Planner
 GH/NP:clr



Neevijan Pugalendiran
 Transportation Planner

Report Reviewed By:



Ray Bacquie, P.Eng., MBA
 Project Director
 Senior Vice-President - Transportation

Table of Contents

1.0	Overview	1
1.1	Background	1
1.2	Purpose.....	1
1.3	Description of the Study Areas	1
2.0	Phase 1 and 2 Summary	2
3.0	2041 Future Transportation Conditions	3
3.1	Alternative Design Concepts.....	3
3.2	Automobile Level of Service Evaluation.....	5
3.2.1	2041 Future Automobile Demand	5
3.2.2	2041 Screenline Capacity Analysis.....	7
3.2.3	2041 Traffic Operations.....	9
3.2.4	2041 Future Intersection Queues.....	12
3.3	Active Transportation	16
3.3.1	Pedestrian Level of Service Evaluation.....	17
3.3.2	Cycling Level of Service Evaluation	18
4.0	Turn Lane Storage and Taper Requirements.....	20
4.1	Exclusive Turn Storage Lengths	20
4.2	Exclusive Turn Taper and Parallel Lane Lengths	25
5.0	Signal Warrants	25
6.0	Summary	26

Tables

Table 1:	Screenline Capacity Analysis - AM 2041 Future Conditions	8
Table 2:	Screenline Capacity Analysis – 2041 PM Future Conditions	8
Table 3:	2041 Future Conditions Traffic Operations for Warden Avenue	9
Table 4:	2041 Future Conditions Traffic Operations for Kennedy Road	11
Table 5:	2041 Future Conditions Queue Summary – Warden Avenue	13
Table 6:	2041 Future Conditions Queue Summary – Kennedy Road	14
Table 7:	2041 Future Conditions Pedestrian Level of Service Evaluation – Warden Avenue.....	17
Table 8:	2041 Future Conditions Pedestrian Level of Service Evaluation – Kennedy Road	18
Table 9:	2041 Future Conditions Cycling Level of Service Evaluation – Warden Avenue.....	19
Table 10:	2041 Future Conditions Cycling Level of Service Evaluation – Kennedy Road	19
Table 11:	Collector Road EA Recommended Storage Lane Lengths for Warden Avenue.....	21
Table 12:	Warden Avenue Proposed Storage Lengths.....	21
Table 13:	Collector Road EA Recommended Storage Lengths for Kennedy Road	22
Table 14:	Kennedy Road Proposed Storage Lengths.....	23

Transportation System Technical Report #3
Warden Avenue and Kennedy Road Class Environmental Assessment
August 2023

Figures

Figure 1: Study Areas2
Figure 2: 2041 Future Roadway Configuration4
Figure 3: 2041 Future Demand6
Figure 4: OTM Book 18 Facility Selection Nomograph 16
Figure 5: Exclusive Left and Right Turn Storage Length Requirements24

Appendices

Appendix A 2041 Automobile Demand
Appendix B 2041 Future Conditions Synchro Analysis
Appendix C Design Standards
Appendix D Signal Warrant Analysis

1.0 Overview

1.1 Background

The Regional Municipality of York (“York Region”) retained R.J Burnside & Associates Ltd. (“Burnside”) to complete a Municipal Class Environmental Assessment (MCEA) for two study corridors: Warden Avenue and Kennedy Road between Major Mackenzie Drive East and Elgin Mills Road East. York Region conducted their Transportation Master Plan (TMP) in 2016. As part of the 2016 TMP, the road needs and justifications were established for the two study corridors meeting the requirements for Phase 1 and 2 of the MCEA process. During this study, the 2022 TMP was approved by York Regional Council on September 29, 2022. The 2022 TMP recommendation aligned with the 2016 TMP for the two study areas.

1.2 Purpose

The purpose of this report is to support the detailed development and assessment of the preferred design concept that satisfies the future transportation needs for the study area and the Warden Avenue and Kennedy Road Municipal Class Environmental Assessment studies’ problem and/or opportunity statement. This statement included the following:

- Transportation network improvements needed to accommodate expansion of the Designated Urban Area.
- Capacity improvements needed to accommodate future travel demands.
- Corridor improvements needed to support walking and cycling.
- Corridor improvements needed to support transit.

1.3 Description of the Study Areas

There are two study corridors, which include the following road segments:

- Warden Avenue, between Major Mackenzie Drive East and Elgin Mills Road East.
- Kennedy Road, between Major Mackenzie Drive East and Elgin Mills Road East.

The study area for Warden Avenue also includes a short segment approximately 65 m south of Major Mackenzie Drive East to include the large culvert that carries Berczy Creek under Warden Avenue. The study area for Kennedy Road also includes a short segment approximately 120 m north of Elgin Mills Road East to include the bridge that carries Bruce Creek under Kennedy Road. While the study areas have been extended to include these two watercourse crossings, the study area limits referenced for the purposes of this report are the intersections at Major Mackenzie Drive East and Elgin Mills Road East.

The Study Areas are shown in Figure 1.

Figure 1: Study Areas

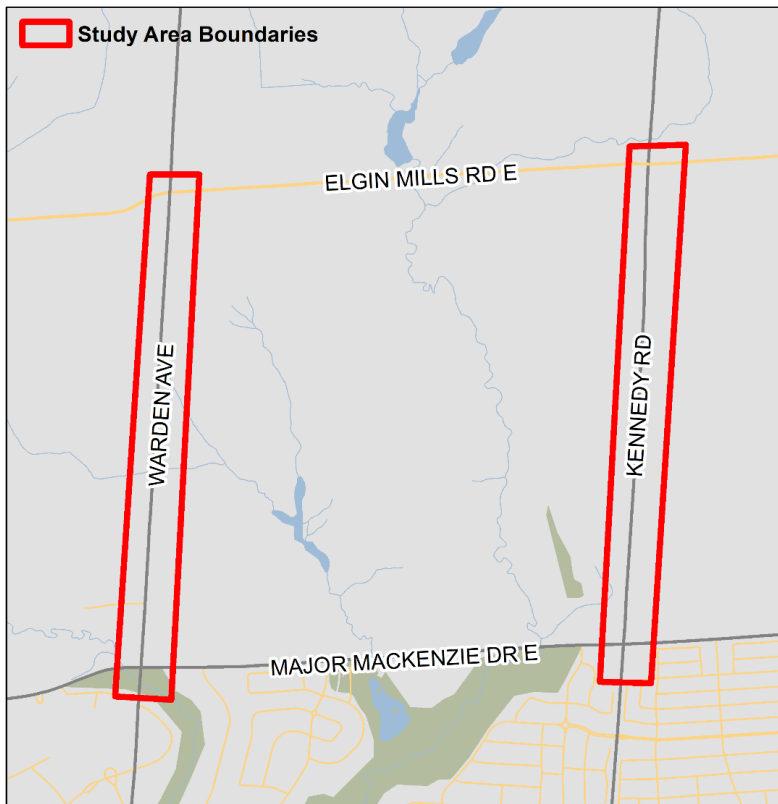

2.0 Phase 1 and 2 Summary

As part of Phase 1 and 2 of the Municipal Class Environmental Assessment process, a transportation assessment was completed to assess existing and future traffic operations and safety of the study corridors to identify any operational constraints and potential safety related concerns. Burnside confirmed and built upon the findings of York Region's 2016 TMP.

A few key findings from the transportation assessment are summarized below:

- During the 2041 AM and PM peak hours, the traffic operations analysis indicated that all 4 intersections were forecasted to operate above capacity at LOS F indicating a need for intersection improvements.
- There are no existing dedicated cycling facilities along Warden Avenue or Kennedy Road within the study areas.
- Pedestrian Levels-of-Service did not meet the target of LOS C for many legs of intersections and roadway segments within the study corridors under the existing conditions.

Transportation System Technical Report #3
Warden Avenue and Kennedy Road Class Environmental Assessment
August 2023

The 2016 TMP assessed six alternative scenarios for Warden Avenue between Major Mackenzie Drive and Donald Cousens Parkway and five alternative scenarios for Kennedy Road between Major Mackenzie Drive and Donald Cousens Parkway. The preferred alternative scenario for each corridor was to widen the corridors to four lanes and construct to an urban arterial standard.

The transportation assessment and evaluation of alternative scenarios are detailed in Transportation System Technical Report #1/#2 (June 2022).

3.0 2041 Future Transportation Conditions

3.1 Alternative Design Concepts

The three alternative design concepts that were developed include the following:

- A four-lane cross section with active transportation facilities and a 3.0 m median island.
- A four-lane cross section with active transportation facilities and a 5.0 m median island.
- A four-lane cross-section with active transportation facilities and no island.

All alternative design concepts include provisions of continuous dedicated active transportation facilities to accommodate pedestrian and cyclist movements. This section outlines the future transportation conditions based on automobile, pedestrian, and cycling level-of-service (LOS) evaluation. The Region's November 2016 Transportation Mobility Plan Guidelines were taken into consideration.

The future transportation conditions reflect all three alternative design concepts as the main difference is the provision of a median island which does not influence the multi-modal level-of-service evaluation. The roadway configuration for all design concepts is illustrated in Figure 2.

Figure 2: 2041 Future Roadway Configuration

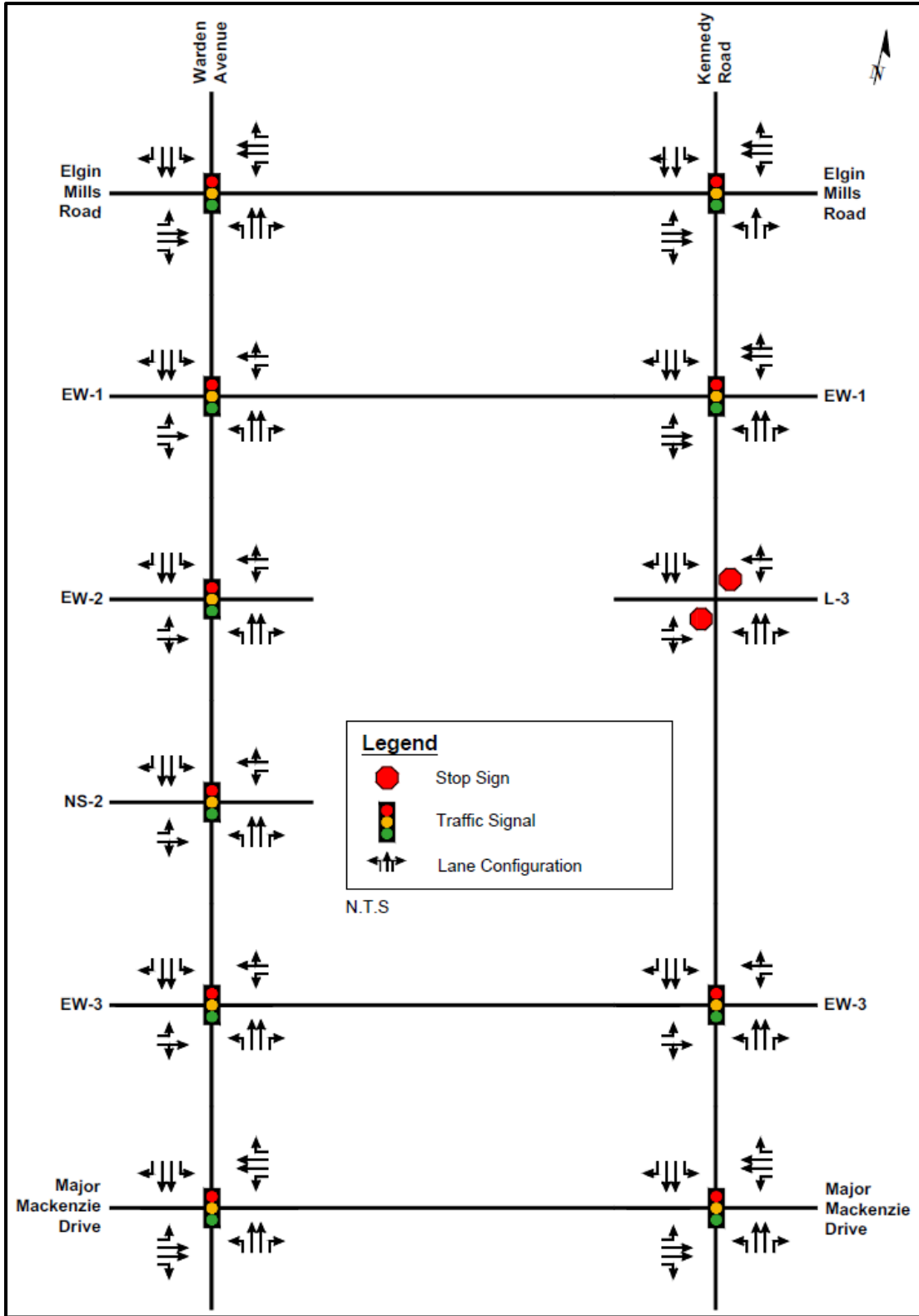

Transportation System Technical Report #3
Warden Avenue and Kennedy Road Class Environmental Assessment
August 2023

3.2 Automobile Level of Service Evaluation

The traffic analysis below analyzes the automobile performance within the study areas and evaluates the performance based on the targets.

3.2.1 2041 Future Automobile Demand

Link and intersection traffic volumes for the “Do Nothing” scenario were derived using existing turning movement counts, the Region’s base year (2016) EMME model, and the Region’s 2031 and 2041 horizon year EMME models. The methodology to derive future 2041 automobile demand is outlined in Transportation System Technical Report #1/#2 (June 2022). A summary of the 2041 “Do Nothing” demand is shown in Appendix A.

Transportation studies have also been conducted to support the Municipal Environmental Servicing Plans for the Angus Glen Block, Berczy Glen Block, Robinson Glen Block, and Victoria Glen Block. These studies have relied on the Updated Transportation Study supporting the City of Markham’s Community Master Plan for forecast horizon year conditions such as traffic demand on the proposed collector road network. The 2026 and 2031 site traffic for Angus Glen and Berczy Glen blocks are shown in Appendix A.

The 2041 future conditions were derived by incorporating the 2041 “Do Nothing” automobile demand balanced with the site traffic generated from the built-out conditions of the future development within the Angus Glen, Berczy Glen, and Robinson Glen Blocks. The 2041 total automobile demand is shown in Figure 3.

Transportation System Technical Report #3
 Warden Avenue and Kennedy Road Class Environmental Assessment
 August 2023

Figure 3: 2041 Future Demand

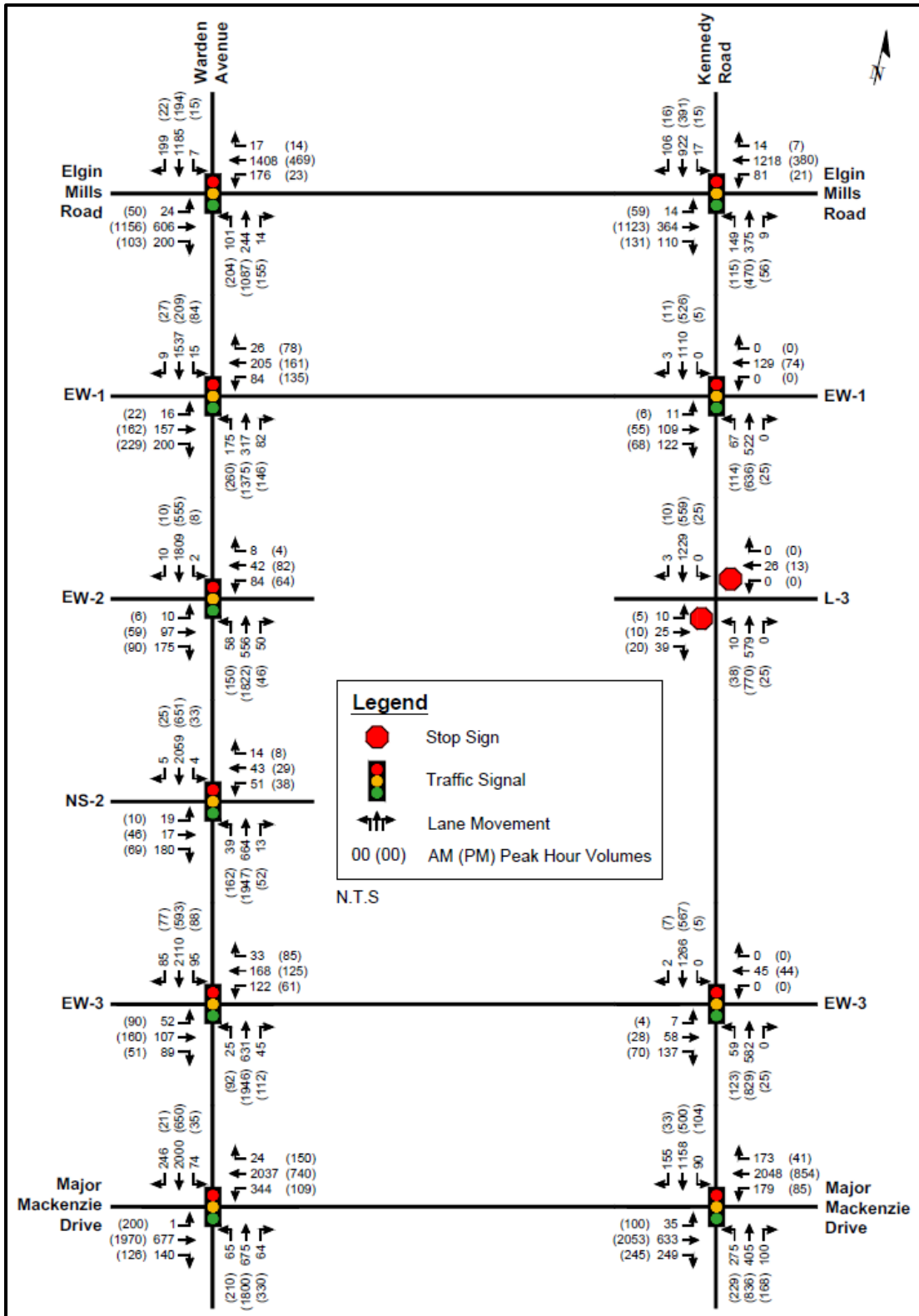

Transportation System Technical Report #3
Warden Avenue and Kennedy Road Class Environmental Assessment
August 2023

3.2.2 2041 Screenline Capacity Analysis

The 2041 v/c ratios for northbound and southbound screenlines across Warden Avenue and Kenney Road were calculated for the weekday AM and PM peak hours using the 2041 forecasted traffic volumes. Congested links are assumed to have a link volume-to-capacity ratios greater than 0.90 and are highlighted in the tables below in red. Only auto volumes and auto link capacities were considered in this analysis.

The results for the Warden Avenue and Kennedy Road screenline are presented in Table 1 for the AM peak and Table 2 for the PM peak.

Transportation System Technical Report #3
 Warden Avenue and Kennedy Road Class Environmental Assessment
 August 2023

Table 1: Screenline Capacity Analysis - AM 2041 Future Conditions

Warden Avenue and Kennedy Road Screenline	# of Lanes	Total Capacity [veh/hr]	Volume [veh]	v/c ratio	# of Lanes	Total Capacity [veh/hr]	Volume [veh]	v/c ratio
	Southbound				Northbound			
South of Elgin Mills Road East	4	3,600	2,673	0.74	4	3,600	892	0.25
South of EW-1	4	3,600	3,053	0.85	4	3,600	1,163	0.32
South of EW-2 / L-3	4	3,600	3,336	0.93	4	3,600	1,253	0.35
North of Major Mackenzie Drive East	4	3,600	3,724	1.03	4	3,600	1,342	0.37

Table 2: Screenline Capacity Analysis – 2041 PM Future Conditions

Warden Avenue and Kennedy Road Screenline	# of Lanes	Total Capacity [veh/hr]	Volume [veh]	v/c ratio	# of Lanes	Total Capacity [veh/hr]	Volume [veh]	v/c ratio
	Southbound				Northbound			
South of Elgin Mills Road East	4	3,600	862	0.24	4	3,600	2,088	0.58
South of EW-1	4	3,600	1167	0.32	4	3,600	2,556	0.71
South of EW-2	4	3,600	1288	0.36	4	3,600	2,851	0.79
North of Major Mackenzie Drive East	4	3,600	1342	0.37	4	3,600	3,127	0.87

The screenline capacity analysis indicated that Warden Avenue and Kennedy Road will operate under capacity throughout the majority of the corridors. The analysis also indicated that the corridors would operate with demand close to or above capacity in the southbound direction during the AM peak hour between Major Mackenzie Drive East and EW-2.

3.2.3 2041 Traffic Operations

The 2041 future conditions were analyzed for the weekday AM and PM peak hours. The 2016 TMP recommended Major Mackenzie Drive to be widened to six lanes to accommodate for two transit/HOV lanes. This traffic analysis involves a more conservative approach and assumes Major Mackenzie Drive is 4 lanes and does not include the transit/HOV lanes.

The traffic operation results for Warden Avenue are shown in Table 3 and for Kennedy Road are shown in Table 4. Detailed results are provided in Appendix B. York Region's automobile level-of-service (LOS) is LOS D or v/c of 0.85 or better for urban areas based on the Region's Mobility Plan Guidelines. Critical movements are highlighted in red.

Table 3: 2041 Future Conditions Traffic Operations for Warden Avenue

Movement	Weekday AM Peak Hour		Weekday PM Peak Hour	
	v/c	LOS	v/c	LOS
Warden Avenue and Elgin Mills Road East				
Overall	0.96	D	0.80	C
EBL	0.48	C	0.16	C
EBT	0.45	C	0.85	D
EBR	0.20	C	0.11	C
WBL	0.73	B	0.42	C
WBT	0.98	C	0.34	B
WBR	0.01	C	0.01	C
NBL	0.71	E	0.38	C
NBT	0.17	B	0.70	C
NBR	0.01	A	0.19	C
SBL	0.02	C	0.14	C
SBT	0.97	E	0.17	C
SBR	0.29	C	0.01	C
Warden Avenue and EW-1				
Overall	0.83	C	0.68	C
EBL	0.11	D	0.16	D
EBT	0.69	E	0.69	E
EBR	0.31	D	0.16	D
WBL	0.42	D	0.68	D
WBTR	0.62	D	0.62	D
NBL	0.69	E	0.36	A
NBT	0.14	C	0.63	A
NBR	0.06	E	0.13	A
SBL	0.03	B	0.60	C
SBT	0.90	C	0.12	B
SBR	0.01	B	0.02	B

Transportation System Technical Report #3
 Warden Avenue and Kennedy Road Class Environmental Assessment
 August 2023

Movement	Weekday AM Peak Hour		Weekday PM Peak Hour	
	v/c	LOS	v/c	LOS
Warden Avenue and EW-2				
Overall	0.90	D	0.78	B
EBL	0.05	D	0.05	D
EBTR	0.84	E	0.61	E
WBL	0.54	D	0.40	D
WBTR	0.10	D	0.26	D
NBL	0.47	F	0.28	A
NBT	0.27	A	0.79	B
NBR	0.03	A	0.03	A
SBL	0.00	B	0.13	B
SBT	0.99	D	0.28	B
SBR	0.01	B	0.01	B
Warden Avenue and NS-2				
Overall	0.81	B	0.69	A
EBL	0.09	D	0.08	D
EBTR	0.76	E	0.48	E
WBL	0.54	E	0.53	E
WBTR	0.17	D	0.19	D
NBL	0.72	E	0.30	A
NBT	0.26	A	0.71	A
NBR	0.01	A	0.04	A
SBL	0.01	A	0.35	B
SBT	0.82	A	0.24	A
SBR	0.00	A	0.02	A
Warden Avenue and EW-3				
Overall	0.96	C	0.93	D
EBL	0.34	D	0.62	D
EBTR	0.54	D	0.55	D
WBL	0.73	E	0.38	D
WBTR	0.75	E	0.79	E
NBL	0.47	E	0.22	B
NBT	0.33	D	1.01	D
NBR	0.03	B	0.08	B
SBL	0.21	B	0.65	D
SBT	0.96	C	0.27	A
SBR	0.06	B	0.05	A
Warden Avenue and Major Mackenzie Drive East				
Overall	1.53	F	1.45	F
EBL	0.02	C	0.78	D
EBT	0.66	D	1.40	F
EBR	0.16	C	0.11	C
WBL	1.42	F	0.72	E
WBT	1.45	F	0.44	C
WBR	0.02	C	0.16	C
NBL	0.51	C	1.09	F

Transportation System Technical Report #3
Warden Avenue and Kennedy Road Class Environmental Assessment
August 2023

Movement	Weekday AM Peak Hour		Weekday PM Peak Hour	
	v/c	LOS	v/c	LOS
NBT	0.46	C	1.50	F
NBR	0.05	B	0.47	C
SBL	0.34	C	0.67	F
SBT	1.61	F	0.73	D
SBR	0.33	C	0.01	C

Table 4: 2041 Future Conditions Traffic Operations for Kennedy Road

Movement	Weekday AM Peak Hour		Weekday PM Peak Hour	
	v/c	LOS	v/c	LOS
Kennedy Road and Elgin Mills Road East				
Overall	0.99	D	0.85	C
EBL	0.31	A	0.20	A
EBT	0.29	A	0.89	C
EBR	0.08	A	0.18	A
WBL	0.27	C	0.46	C
WBT	0.96	D	0.30	C
WBR	0.01	C	0.01	B
NBL	0.91	F	0.41	B
NBT	0.54	B	0.74	C
NBR	0.01	B	0.08	A
SBL	0.07	C	0.12	C
SBTR	1.04	D	0.46	D
Kennedy Road and EW-1				
Overall	0.44	B	0.24	B
EBL	0.10	D	0.07	E
EBTR	0.52	E	0.26	E
WBTR	0.42	E	0.29	E
NBL	0.23	B	0.19	B
NBT	0.20	B	0.24	B
NBR	-	-	0.02	B
SBL	-	-	0.01	A
SBT	0.43	A	0.20	A
SBR	0.00	A	0.01	A
Kennedy Road and L-3 (unsignalized)				
EBL	0.29	F	0.04	E
EBTR	0.56	F	0.15	C
WBL	0.00	A	0.00	A
WBTR	0.48	F	0.14	E
NBL	0.02	B	0.04	A
SBL	0.00	-	0.03	A
Kennedy Road and EW-3				
Overall	0.54	B	0.31	A
EBL	0.04	D	0.04	E
EBTR	0.70	E	0.26	E

Transportation System Technical Report #3
Warden Avenue and Kennedy Road Class Environmental Assessment
August 2023

Movement	Weekday AM Peak Hour		Weekday PM Peak Hour	
	v/c	LOS	v/c	LOS
WBTR	0.19	D	0.31	E
NBL	0.27	A	0.21	A
NBT	0.24	A	0.31	A
NBR	-	-	0.02	A
SBL	-	-	0.01	A
SBT	0.51	B	0.21	A
SBR	0.00	A	0.00	A
Kennedy Road and Major Mackenzie Drive East				
Overall	1.40	F	1.07	F
EBL	0.27	D	0.35	C
EBT	0.45	C	1.35	F
EBR	0.17	E	0.28	D
WBL	0.54	C	0.54	C
WBT	1.39	F	0.57	C
WBR	0.18	C	0.03	C
NBL	1.42	F	0.76	D
NBT	0.33	C	0.64	D
NBR	0.07	C	0.18	C
SBL	0.42	D	0.79	E
SBT	1.40	F	0.57	C
SBR	0.23	C	0.02	D

The results indicated that all signalized intersections except for Kennedy Road and Warden Avenue at Major Mackenzie Drive would operate at sufficient levels of service during the AM and PM peak hours under 2041 conditions.

The demand was forecasted for the purposes of understanding future traffic operations and, it is not possible to have a v/c ratio greater than 1.0. When demand is approaching or meeting practical capacity, this may result in different driving behaviours than modelled in Synchro such as vehicles utilizing more of the yellow or all red phases. In congested conditions, traffic is also anticipated to seek alternatives during the peak hour such as:

- Unserved demand will seek alternative routes.
- Unserved demand will enter the network at a later or earlier time, causing peak period spreading.
- Some users will switch to transit and / or carpooling. This modal shift is expected due to the provision of transit/HOV lanes along Major Mackenzie Drive that was not explicitly taken into consideration in the Synchro analysis.

3.2.4 2041 Future Intersection Queues

The 95th percentile queues for each movement at the study intersections were extracted from the Synchro 11 analysis and summarized in Table 5 for Warden Avenue and Table 6 for Kennedy Road.

Transportation System Technical Report #3
 Warden Avenue and Kennedy Road Class Environmental Assessment
 August 2023

Table 5: 2041 Future Conditions Queue Summary – Warden Avenue

Movement	Weekday AM Peak Hour 95th % Queue (m)	Weekday PM Peak Hour 95th % Queue (m)
Warden Avenue and Elgin Mills Road East		
EBL	19	17
EBT	78	168
EBR	28	17
WBL	39	15
WBT	238	67
WBR	0	2
NBL	40	55
NBT	15	128
NBR	1	40
SBL	5	10
SBT	217	31
SBR	47	0
Warden Avenue and EW-1		
EBL	11	14
EBT	64	64
EBR	33	23
WBL	32	47
WBTR	81	78
NBL	75	25
NBT	42	70
NBR	22	11
SBL	3	47
SBT	110	16
SBR	0	0
Warden Avenue and EW-2		
EBL	8	6
EBTR	96	49
WBL	31	26
WBTR	20	34
NBL	22	21
NBT	23	135
NBR	2	1
SBL	1	4
SBT	329	58
SBR	0	0
Warden Avenue and NS-2		
EBL	12	9
EBTR	73	39
WBL	26	22
WBTR	23	19
NBL	33	18
NBT	15	136
NBR	1	4
SBL	1	9
SBT	76	16
SBR	0	1

Transportation System Technical Report #3
 Warden Avenue and Kennedy Road Class Environmental Assessment
 August 2023

Movement	Weekday AM Peak Hour 95th % Queue (m)	Weekday PM Peak Hour 95th % Queue (m)
Warden Avenue and EW-3		
EBL	22	6
EBTR	68	77
WBL	53	31
WBTR	76	82
NBL	18	23
NBT	118	370
NBR	12	11
SBL	14	41
SBT	375	49
SBR	6	6
Warden Avenue and Major Mackenzie Drive East		
EBL	2	92
EBT	105	428
EBR	24	17
WBL	68	47
WBT	239	84
WBR	0	29
NBL	19	94
NBT	84	408
NBR	9	75
SBL	18	29
SBT	468	109
SBR	38	0

Table 6: 2041 Future Conditions Queue Summary – Kennedy Road

Movement	Weekday AM Peak Hour 95th % Queue (m)	Weekday PM Peak Hour 95th % Queue (m)
Kennedy Road and Elgin Mills Road East		
EBL	0	7
EBT	6	132
EBR	1	2
WBL	26	13
WBT	188	43
WBR	0	0
NBL	60	12
NBT	50	47
NBR	0	2
SBL	9	9
SBTR	184	63
Kennedy Road and EW-1		
EBL	9	7
EBTR	33	18
WBL	-	-
WBTR	28	19
NBL	25	43
NBT	64	93
NBR	-	5

Transportation System Technical Report #3
 Warden Avenue and Kennedy Road Class Environmental Assessment
 August 2023

Movement	Weekday AM Peak Hour 95th % Queue (m)	Weekday PM Peak Hour 95th % Queue (m)
SBL	-	1
SBT	21	10
SBR	0	0
Kennedy Road and L-3 (Unsignalized)		
EBL	8	1
EBTR	21	4
WBL	0	0
WBTR	14	4
NBL	1	1
NBT	0	0
NBR	0	0
SBL	0	1
SBT	0	0
SBR	0	0
Kennedy Road and EW-3		
EBL	7	5
EBTR	61	25
WBL	-	-
WBTR	22	24
NBL	7	3
NBT	21	7
NBR	-	1
SBL	-	3
SBT	182	65
SBR	0	2
Kennedy Road and Major Mackenzie Drive East		
EBL	11	15
EBT	73	229
EBR	28	26
WBL	39	23
WBT	453	108
WBR	29	0
NBL	142	64
NBT	57	117
NBR	12	28
SBL	29	46
SBT	268	87
SBR	26	1

The storage lengths for traffic movements on Warden Avenue, Kennedy Road, Elgin Mills Road, and Major Mackenzie Drive was calculated by using the highest 95th percentile storage length demand of the AM and PM peak hour as calculated by the Synchro traffic analysis.

3.3 Active Transportation

The proposed active transportation improvements along Warden Avenue and Kennedy Road include an in-boulevard cycle track (1.50 m to 1.80 m wide) and sidewalk (1.50 m wide) on both sides of the road. Generous planting and boulevard space is provided separating the cycle track from the sidewalk and the cycle track from the travel lane.

This proposed infrastructure provides cyclists and pedestrians each with their own separated pathway to travel along Warden Avenue and Kennedy Road with ease and comfort as they would be physically separated from vehicles.

Proposed active transportation improvements along the collector roads include a multi-use path (3.0 m wide) separated by a planting zone.

OTM Book 18 provides direction on active transportation facility selection and recommends the use of a Desirable Cycling Facility Pre-selection Nomograph as shown in Figure 4. This nomograph is used in urban/suburban contexts such as the Future Urban Area. Along both Warden Avenue and Kennedy Road, the forecasted AADT is anticipated to be greater than 10,000 vehicles per day. At a posted speed limit of 60 km/hr., a physically separated bikeway is recommended which can include a separated bicycle lane, cycle track, and multi-use path. The cycle track recommendation for the alternative design concepts aligns with the recommendations of OTM Book 18.

Figure 4: OTM Book 18 Facility Selection Nomograph

**Desirable Cycling Facility Pre-Selection Nomograph
 Urban/Suburban Context (Step 1)**

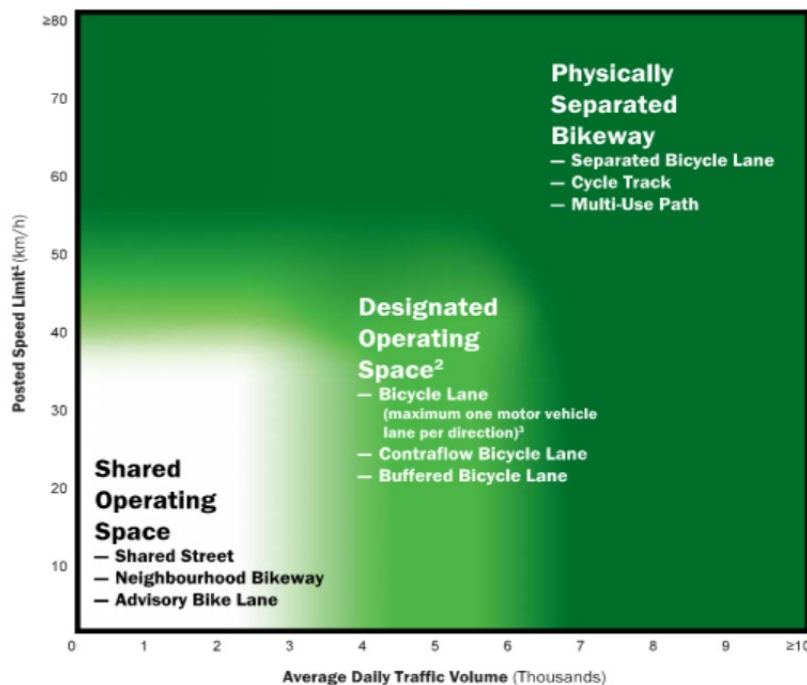

Transportation System Technical Report #3
Warden Avenue and Kennedy Road Class Environmental Assessment
August 2023

3.3.1 Pedestrian Level of Service Evaluation

York Region's pedestrian level-of-service (LOS) target is LOS C or better. The analysis shown in Table 7 analyzes the pedestrian performance along Warden Avenue based on criteria from York Region's Mobility Plan Guidelines within the study areas and evaluates the performance based on the target. Pedestrian performance along Kennedy Road is shown in Table 8.

Table 7: 2041 Future Conditions Pedestrian Level of Service Evaluation – Warden Avenue

Intersection	Direction	Segment		Intersection LOS
		Description	LOS	
Elgin Mills Road East and Warden Avenue	Eastbound	Elgin Mills Road East	B	B
	Westbound	Elgin Mills Road East	B	B
	Northbound	Warden Avenue	B	B
	Southbound	Warden Avenue	B	B
EW-1 and Warden Avenue	Eastbound	EW-1	B	B
	Westbound	EW-1	B	B
	Northbound	Warden Avenue	B	B
	Southbound	Warden Avenue	B	B
EW-2 and Warden Avenue	Eastbound	EW-2	B	B
	Westbound	EW-2	B	B
	Northbound	Warden Avenue	B	B
	Southbound	Warden Avenue	B	B
NS-2 and Warden Avenue	Eastbound	NS-2	B	B
	Westbound	NS-2	B	B
	Northbound	Warden Avenue	B	B
	Southbound	Warden Avenue	B	B
EW-3 and Warden Avenue	Eastbound	EW-3	B	B
	Westbound	EW-3	B	B
	Northbound	Warden Avenue	B	B
	Southbound	Warden Avenue	B	B
Major Mackenzie Drive East and Warden Avenue	Eastbound	Major Mackenzie Drive East	B	B
	Westbound	Major Mackenzie Drive East	B	B
	Northbound	Warden Avenue	B	B
	Southbound	Warden Avenue	B	B

Table 8: 2041 Future Conditions Pedestrian Level of Service Evaluation – Kennedy Road

Intersection	Direction	Segment		Intersection LOS
		Description	LOS	
Elgin Mills Road East and Kennedy Road	Eastbound	Elgin Mills Road East	B	B
	Westbound	Elgin Mills Road East	B	B
	Northbound	Kennedy Road	B	B
	Southbound	Kennedy Road	B	B
EW-1 and Kennedy Road	Eastbound	EW-1	B	B
	Westbound	EW-1	B	B
	Northbound	Kennedy Road	B	B
	Southbound	Kennedy Road	B	B
L-3 and Kennedy Road	Eastbound	L-3	B	B
	Westbound	L-3	B	B
	Northbound	Kennedy Road	B	B
	Southbound	Kennedy Road	B	B
EW-3 and Kennedy Road	Eastbound	EW-3	B	B
	Westbound	EW-3	B	B
	Northbound	Kennedy Road	B	B
	Southbound	Kennedy Road	B	B
Major Mackenzie Drive East and Kennedy Road	Eastbound	EW-3	B	B
	Westbound	EW-3	B	B
	Northbound	Kennedy Road	B	B
	Southbound	Kennedy Road	B	B

The pedestrian level of service evaluation shows that the alternative design concepts greatly improve the pedestrian experience meeting the Region's target based on the Mobility Plan Guidelines and satisfying the problem and/or opportunity statement of the Class EAs.

For these pedestrian facilities to be granted a LOS A, a width of at least 2.0 metre would have to be provided. However, given the physical and environmental right-of-way constraints of the corridor and the provision of generous planting and boulevard space, a 1.50 metre sidewalk is more than sufficient along this corridor.

3.3.2 Cycling Level of Service Evaluation

York Region's cycling level-of-service (LOS) target is LOS C or better. The analysis shown in Table 9 analyzes the cycling performance based on criteria from York Region's Mobility Plan Guidelines. Cycling performance along Kennedy Road is shown in Table 10.

Table 9: 2041 Future Conditions Cycling Level of Service Evaluation – Warden Avenue

Intersection	Direction	Segment		Intersection LOS
		Description	LOS	
Elgin Mills Road East and Warden Avenue	Eastbound	Elgin Mills Road East	A	A
	Westbound	Elgin Mills Road East	A	A
	Northbound	Warden Avenue	A	A
	Southbound	Warden Avenue	A	A
EW-1 and Warden Avenue	Eastbound	EW-1	A	A
	Westbound	EW-1	A	A
	Northbound	Warden Avenue	A	A
	Southbound	Warden Avenue	A	A
EW-2 and Warden Avenue	Eastbound	EW-2	A	A
	Westbound	EW-2	A	A
	Northbound	Warden Avenue	A	A
	Southbound	Warden Avenue	A	A
NS-2 and Warden Avenue	Eastbound	NS-2	A	A
	Westbound	NS-2	A	A
	Northbound	Warden Avenue	A	A
	Southbound	Warden Avenue	A	A
EW-3 and Warden Avenue	Eastbound	EW-3	A	A
	Westbound	EW-3	A	A
	Northbound	Warden Avenue	A	A
	Southbound	Warden Avenue	A	A
Major Mackenzie Drive East and Warden Avenue	Eastbound	Major Mackenzie Drive East	A	A
	Westbound	Major Mackenzie Drive East	A	A
	Northbound	Warden Avenue	A	A
	Southbound	Warden Avenue	A	A

Table 10: 2041 Future Conditions Cycling Level of Service Evaluation – Kennedy Road

Intersection	Direction	Segment		Intersection LOS
		Description	LOS	
Elgin Mills Road East and Kennedy Road	Eastbound	Elgin Mills Road East	A	A
	Westbound	Elgin Mills Road East	A	A
	Northbound	Kennedy Road	A	A
	Southbound	Kennedy Road	A	A
EW-1 and Kennedy Road	Eastbound	EW-1	A	A
	Westbound	EW-1	A	A
	Northbound	Kennedy Road	A	A
	Southbound	Kennedy Road	A	A
L-3 and Kennedy Road	Eastbound	L-3	A	A
	Westbound	L-3	A	A

Intersection	Direction	Segment		Intersection LOS
		Description	LOS	
	Northbound	Kennedy Road	A	A
	Southbound	Kennedy Road	A	A
EW-3 and Kennedy Road	Eastbound	EW-3	A	A
	Westbound	EW-3	A	A
	Northbound	Kennedy Road	A	A
	Southbound	Kennedy Road	A	A
Major Mackenzie Drive East and Kennedy Road	Eastbound	EW-3	A	A
	Westbound	EW-3	A	A
	Northbound	Kennedy Road	A	A
	Southbound	Kennedy Road	A	A

The cycling level of service evaluation shows that the alternative design concepts greatly improve the cycling experience meeting the Region's target based on the Mobility Plan Guidelines and satisfying the problem and/or opportunity statement of the Class EAs.

4.0 Turn Lane Storage and Taper Requirements

4.1 Exclusive Turn Storage Lengths

A detailed analysis was conducted to calculate the minimum exclusive left and right turn vehicle storage length demands at each identified intersection approach. The methodology to calculate these lengths were the following:

- The storage lengths for traffic movements on Warden Avenue, Kennedy Road, Elgin Mills Road, and Major Mackenzie Drive was calculated by using the highest 95th percentile storage length demand of the AM and PM peak hour as calculated by the Synchro traffic analysis.

The Collector Road Environmental Assessments completed by the various landowners within the FUA propose minimum storage lengths within the Study Areas. For left turn movements on the Collector Roads (e.g., EBL and WBL), the proposed storage lengths were obtained from the Collector Road EAs. The Collector Road EAs did not identify exclusive right turn lanes on the Collector Roads. The Collector Road Environmental Assessment storage lane recommendations are shown in Table 11 for Warden Avenue and The recommended storage lane lengths for Collector Roads intersecting with Kennedy Road are shown in Table 13.

- Table 13 for Kennedy Road.
- A minimum of 30.0 m storage length was applied on exclusive left turn lanes and right turn lanes based on York Region's 2023 Road Design Guidelines (YRRDG) DS-105 as shown in Appendix C.

Transportation System Technical Report #3
Warden Avenue and Kennedy Road Class Environmental Assessment
August 2023

The recommended storage lane lengths for Collector Roads intersecting with Warden Avenue are shown in Table 11.

Table 11: Collector Road EA Recommended Storage Lane Lengths for Warden Avenue

Movement	Collector Road EA Recommended Storage Lane Length (m)
Warden Avenue and EW-1	
EBL	30
WBL	35
Warden Avenue and EW-2	
EBL	30
WBL	30
Warden Avenue and NS-2	
EBL	30
WBL	30
Warden Avenue and EW-2	
EBL	30
WBL	30

Based on the methodology identified above, a summary of the proposed storage lanes for all movements is shown in Table 12 for Warden Avenue.

Table 12: Warden Avenue Proposed Storage Lengths

Movement	Proposed Storage Lane (m)
Warden Avenue and Elgin Mills Road East	
EBL	35
EBR	30
WBL	35
WBR	30
NBL	55
NBR	40
SBL	30
SBR	50
Warden Avenue and EW-1	
EBL	30
EBR	35
WBL	35
NBL	75
NBR	30
SBL	50
SBR	30
Warden Avenue and EW-2	
EBL	30
WBL	30
NBL	30

Transportation System Technical Report #3
 Warden Avenue and Kennedy Road Class Environmental Assessment
 August 2023

Movement	Proposed Storage Lane (m)
NBR	30
SBL	30
SBR	30
Warden Avenue and NS-2	
EBL	30
WBL	30
NBL	35
NBR	30
SBL	30
SBR	30
Warden Avenue and EW-2	
EBL	30
WBL	30
NBL	30
NBR	30
SBL	40
SBR	30
Warden Avenue and Major Mackenzie Drive East	
EBL	95
EBR	30
WBL	70
WBR	30
NBL	95
NBR	75
SBL	30
SBR	40

The recommended storage lane lengths for Collector Roads intersecting with Kennedy Road are shown in Table 13.

Table 13: Collector Road EA Recommended Storage Lengths for Kennedy Road

Movement	Collector Road EA Recommended Storage Lane (m)
Kennedy Road and EW-1	
EBL	30
WBL	30
Kennedy Road and L-3 (Unsignalized)	
EBL	30
WBL	25
Kennedy Road and EW-3	
EBL	35
WBL	30

Based on the methodology identified above, a summary of the proposed storage lanes for all movements is shown in Table 14 for Kennedy Road.

Transportation System Technical Report #3
 Warden Avenue and Kennedy Road Class Environmental Assessment
 August 2023

Table 14: Kennedy Road Proposed Storage Lengths

Movement	Proposed Storage Lane (m)
Kennedy Road and Elgin Mills Road East	
EBL	30
EBR	30
WBL	30
WBR	30
NBL	60
NBR	30
SBL	30
Kennedy Road and EW-1	
EBL	30
WBL	30
NBL	45
NBR	30
SBL	30
SBR	30
Kennedy Road and EW-2	
EBL	30
WBL	30
NBL	45
NBR	30
SBL	30
SBR	30
Kennedy Road and L-3 (unsignalized)	
EBL	30
WBL	25
NBL	30
NBR	30
SBL	30
SBR	30
Kennedy Road and EW-3	
EBL	35
WBL	30
NBL	30
NBR	30
SBL	30
SBR	30
Kennedy Road and Major Mackenzie Drive East	
EBL	30
EBR	30
WBL	40
WBR	30
NBL	145
NBR	30
SBL	50
SBR	30

The exclusive left and right turn storage requirements are shown in Figure 5.

Figure 5: Exclusive Left and Right Turn Storage Length Requirements

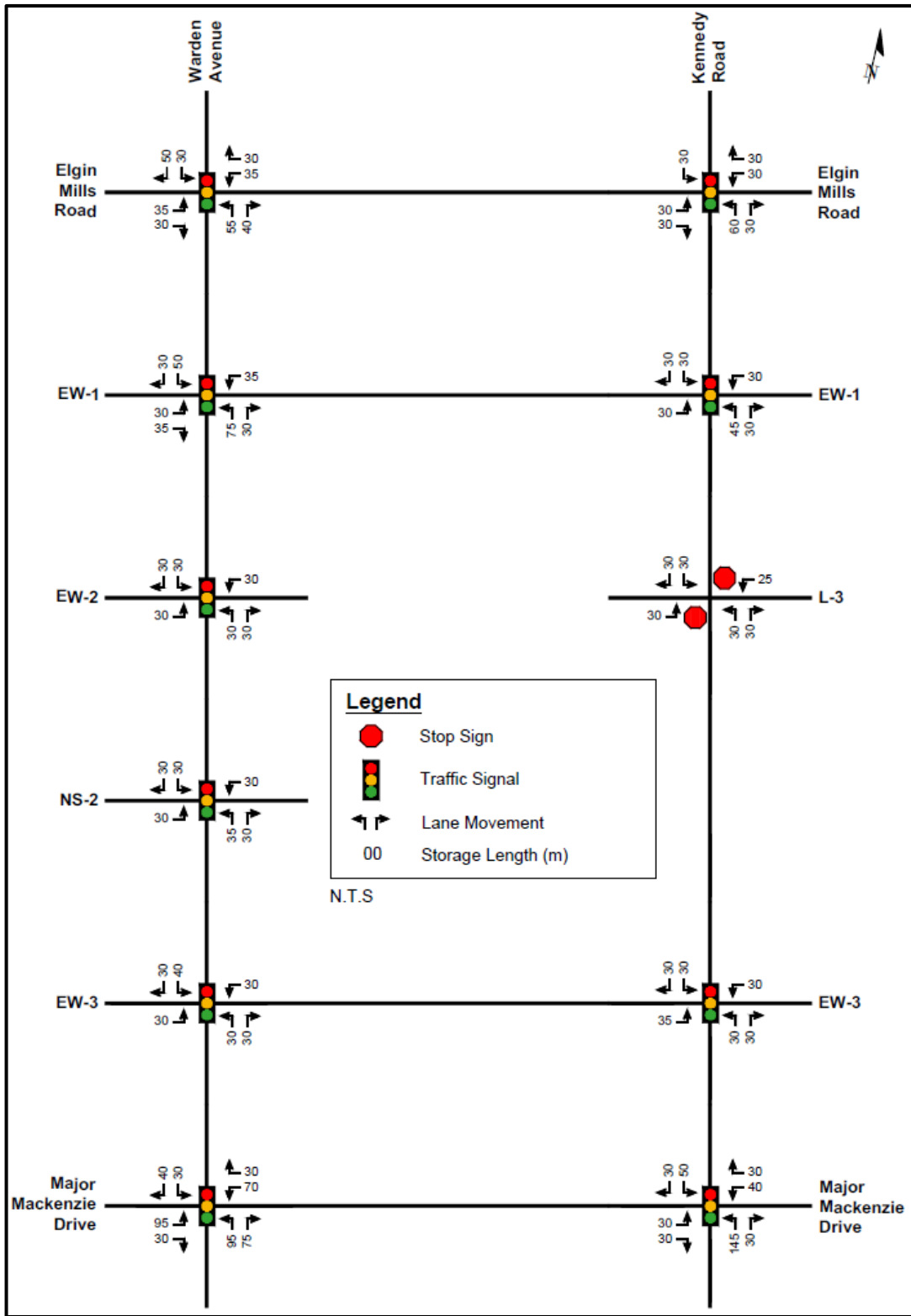

4.2 Exclusive Turn Taper and Parallel Lane Lengths

Based on York Region's Road Design Guidelines (YRRDG) DS-105, the exclusive right taper length for a design speed of 60 km/h on the regional roads should be between 49 m and 59.5 m. The exclusive left taper length for a design speed of 60 km/h on regional roads should be between 49.5 m and 118.8 m. The minimum taper length for lanes centred along the centre line should be 24.75 m.

The taper lengths along the Collector Roads are based on the Collector Road Network Class EAs which have recommended a taper length of 30.0 metres in addition to the storage length for each exclusive left turn at each collector road approach with each Regional road.

5.0 Signal Warrants

Signal warrants were analyzed for the 2041 horizon year based on the Ontario Traffic Manual Book 12 Justification 7 for forecasted volume. This analysis was undertaken for the new Collector roads at Regional road intersections. These warrants require forecasted volumes to be 150% of the volumes to warrant a signal. The results of the signal warrant analysis are shown in Appendix D.

The signal warrant analysis indicated the following intersections along Warden Avenue be signalized:

- Warden Avenue and EW-1.
- Warden Avenue and EW-3.

For Warden Avenue at EW-2 and at NS-2, the signal warrant analysis indicated that the "Total Volume" criteria and "Delay to Cross Traffic" criteria surpassed the 150% threshold for both intersections. To improve operations at these intersections and to be consistent with the planned future urbanized environment, all collector road intersections are recommended to be signalized along Warden Avenue.

The signal warrant analysis did not indicate that any collector road intersection requires signalization along Kennedy Road. However, some collector road intersections were approaching warrants. To improve operations at these intersections, especially the left turn and right turn movements from the collector roads, the following intersections are recommended to be signalized:

- Kennedy Road and EW-1.
- Kennedy Road and EW-3.

Kennedy Road and L-3 is recommended to remain stop controlled. This road segment is short, and its primary purpose is to provide connectivity to internal developments. The future traffic operations analysis indicates that forecasted left turn and right turn volumes are low but the delay for these movements is poor. However, most of these vehicles are expected to be redirected to the adjacent, proposed signalized intersections.

These intersection improvements are consistent with the Collector Road Class Environmental Assessments. The Class EA for the Robinson Glen Block recommends the same intersection improvements as this study. The Class EA for the Angus Glen Block recommends the same intersection improvements, but with the Kennedy Road and L-3 intersection as signalized.

No interim year analysis was conducted to determine the horizon year in which the signals need to be installed. However, the signals are recommended to be installed during the construction of the collector road segments ahead of the developments.

6.0 Summary

A detailed transportation assessment was undertaken to support the development of the preferred design concept that satisfies the future transportation needs for the study area and the Warden Avenue and Kennedy Road Municipal Class Environmental Assessment (EA) studies' problem and/or opportunity statement. This statement included the following:

- Transportation network improvements needed to accommodate expansion of the Designated Urban Area.
- Capacity improvements needed to accommodate future travel demands.
- Corridor improvements needed to support walking and cycling.
- Corridor improvements needed to support transit.

The three alternative design concepts that were developed include the following:

- A four-lane cross section with active transportation facilities and a 3.0 m median island.
- A four-lane cross section with active transportation facilities and a 5.0 m median island.
- A four-lane cross-section with active transportation facilities and no island.

Multi-Modal Level of Service Evaluation

This transportation assessment reflects all three alternative design concepts as the main difference is the provision of a median island which does not influence the multi-modal level-of-service evaluation. A summary of the evaluation is outlined below:

- The screenline capacity analysis indicated that Warden Avenue and Kennedy Road will operate under capacity throughout the majority of the corridors. The analysis also indicated that the corridors would operate with demand close to or above capacity in the southbound direction during the AM peak hour between Major Mackenzie Drive East and EW-2.
- The results indicated that all intersections except for Kennedy Road and Warden Avenue at Major Mackenzie Drive would operate at sufficient levels of service during the AM and PM peak hours.
- Although there will be localized congestion along the corridors near Major Mackenzie Drive in the AM peak hour, driving trips are anticipated to peak spread, take alternative routes adjacent to the study areas, or switch to more sustainable modes of transportation.

Transportation System Technical Report #3
Warden Avenue and Kennedy Road Class Environmental Assessment
August 2023

- Driving trips within the study areas, especially along Major Mackenzie Drive, are also anticipated to switch to more sustainable modes with the planned transit/HOV lanes along Major Mackenzie Drive.
- The proposed storage lengths are anticipated to address the 95th% queues during the AM and PM peak hours.
- The proposed cycle track, sidewalk, and planting and boulevard space more than adequately accommodates active transportation objectives by adding to the safety and comfort for pedestrian and cyclists.

Based on the transportation multi-modal level of service assessment, all three alternative design concepts adequately meet the problem/opportunity statement of the Class EAs and support the future development of the FUA.

Turn Lane Storage and Taper Requirements

The proposed minimum turn lane storage lengths were based on the traffic analysis and the Collector Road EAs.

Based on York Region's Road Design Guidelines (YRRDG) DS-105, the exclusive right taper length for a design speed of 60 km/h on the regional roads should be between 49 m and 59.5 m. The exclusive left taper length for a design speed of 60 km/h on regional roads should be between 49.5 m and 118.8 m. The minimum taper length for lanes centred along the centre line should be 24.75 m.

Signal Improvements

The following intersections along the Warden Avenue study corridor are recommended to be signalized:

- Warden Avenue and EW-1.
- Warden Avenue and EW-2.
- Warden Avenue and EW-3.
- Warden Avenue and NS-2.

The following intersections along the Kennedy Road study corridor are recommended to be signalized:

- Kennedy Road and EW-1.
- Kennedy Road and EW-3.

The signals are recommended to be installed during the construction of the collector road segments in preparation for the planned future developments. The Kennedy Road and L-3 intersection should be monitored for future signalization consideration.



BURNSIDE

[THE DIFFERENCE IS OUR PEOPLE]

Appendix A

2041 Automobile Demand

Existing “Do Nothing” Traffic Volumes (2021)

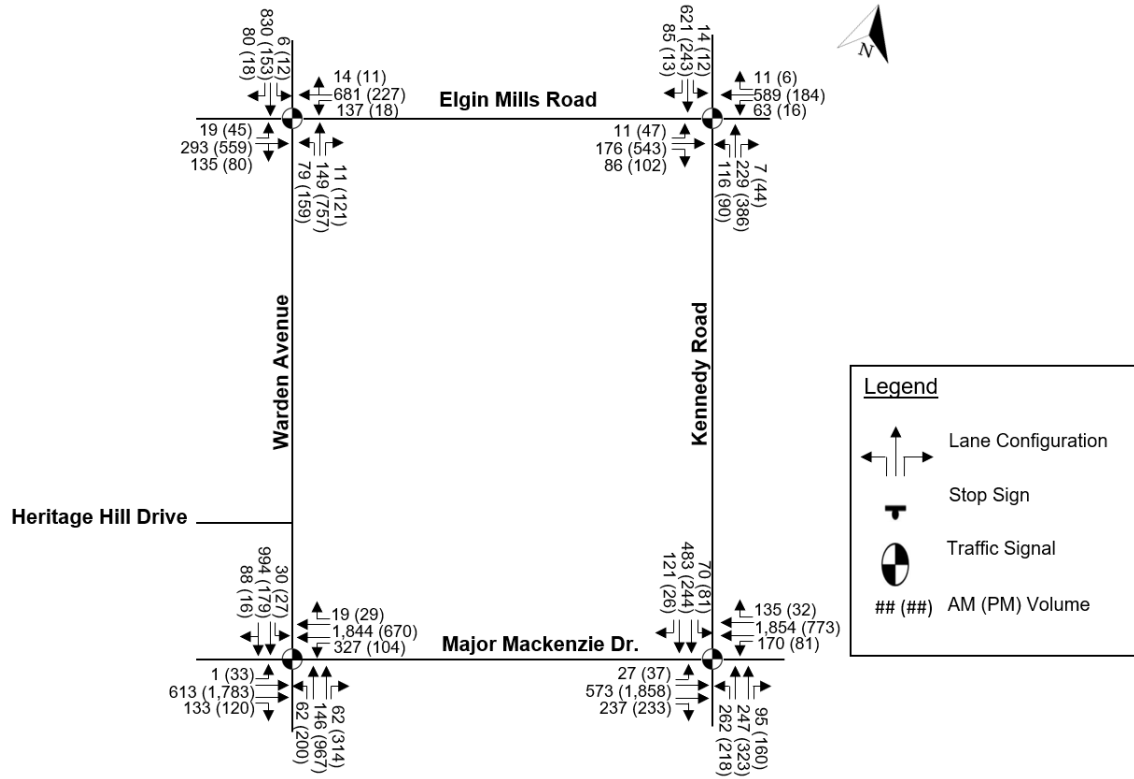

Source: Transportation Technical Report #1

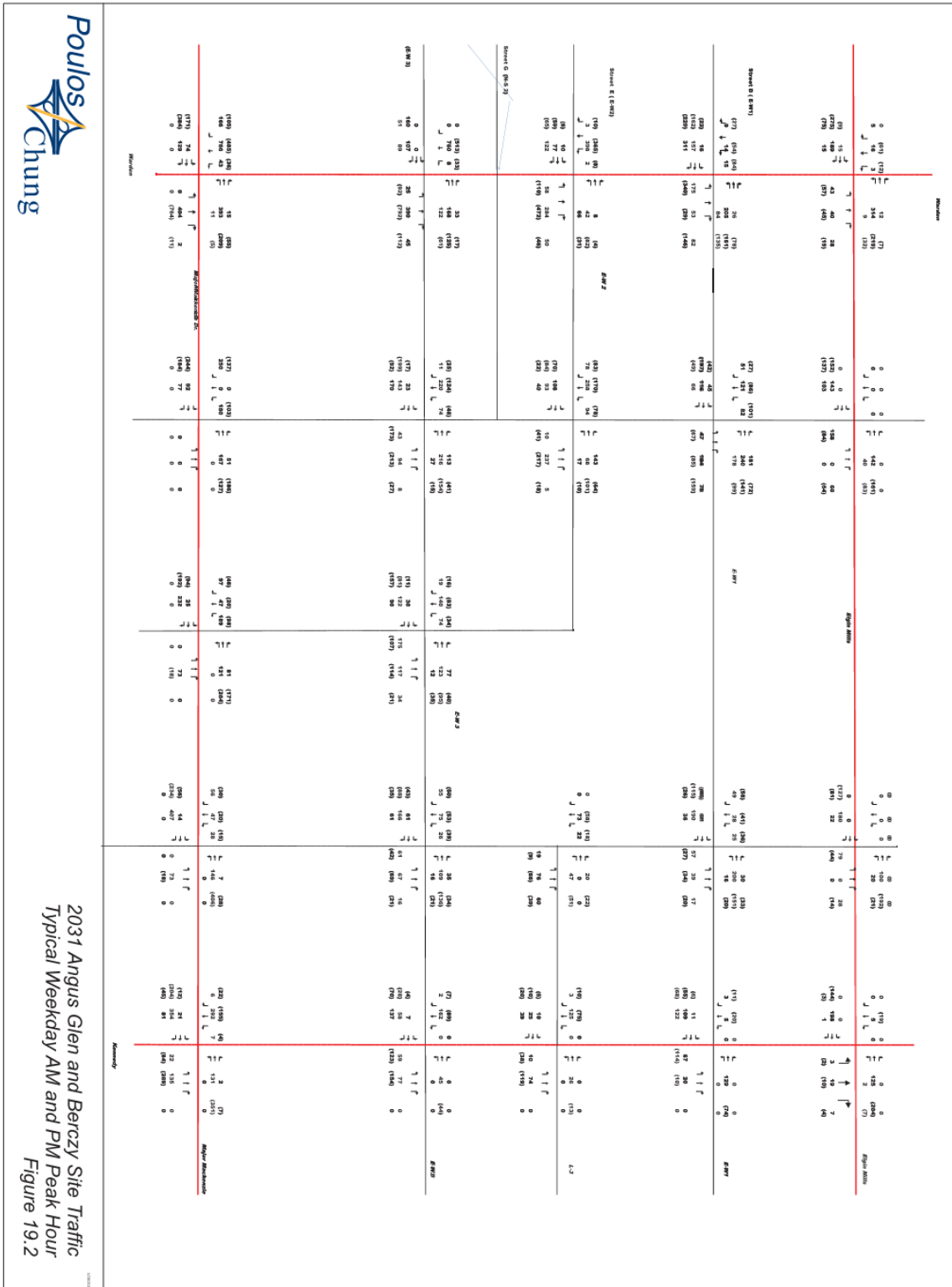



BURNSIDE

[THE DIFFERENCE IS OUR PEOPLE]

Appendix B

2041 Future Conditions Synchro Analysis

Timings
1: Warden Avenue & Elgin Mills Road

BG 2041 AM
Baseline

	EBL	EBT	EBR	WBL	WBT	WBR	NBL	NBT	NBR	SBL	SBT	SBR
Lane Configurations	↔	↔	↔	↔	↔	↔	↔	↔	↔	↔	↔	↔
Traffic Volume (vph)	24	606	200	176	1408	17	101	244	14	7	1185	199
Future Volume (vph)	24	606	200	176	1408	17	101	244	14	7	1185	199
Lane Group Flow (vph)	26	659	217	191	1530	18	110	265	15	8	1288	216
Turn Type	Perm	NA	Perm	Perm	NA	Perm	pm+pt	NA	Perm	Perm	NA	Perm
Protected Phases		4			8		5	2			6	
Permitted Phases	4		4	8		8	2		2	6		6
Detector Phase	4	4	4	8	8	8	5	2	2	6	6	6
Switch Phase												
Minimum Initial (s)	10.0	10.0	10.0	10.0	10.0	10.0	7.0	30.0	30.0	30.0	30.0	30.0
Minimum Split (s)	41.5	41.5	41.5	41.5	41.5	41.5	11.0	47.0	47.0	47.0	47.0	47.0
Total Split (s)	63.6	63.6	63.6	63.6	63.6	63.6	11.0	66.4	66.4	55.4	55.4	55.4
Total Split (%)	48.9%	48.9%	48.9%	48.9%	48.9%	48.9%	8.5%	51.1%	51.1%	42.6%	42.6%	42.6%
Yellow Time (s)	4.5	4.5	4.5	4.5	4.5	4.5	3.0	5.0	5.0	5.0	5.0	5.0
All-Red Time (s)	2.5	2.5	2.5	2.5	2.5	2.5	1.0	2.0	2.0	2.0	2.0	2.0
Lost Time Adjust (s)	0.0	0.0	0.0	0.0	0.0	0.0	0.0	0.0	0.0	0.0	0.0	0.0
Total Lost Time (s)	7.0	7.0	7.0	7.0	7.0	7.0	4.0	7.0	7.0	7.0	7.0	7.0
Lead/Lag							Lead			Lag	Lag	Lag
Lead-Lag Optimize?							Yes			Yes	Yes	Yes
Recall Mode	None	None	None	None	None	None	None	C-Max	C-Max	C-Max	C-Max	C-Max
v/c Ratio	0.48	0.45	0.29	0.73	0.98	0.02	0.70	0.17	0.02	0.02	0.97	0.34
Control Delay	60.2	27.0	9.0	22.2	30.3	0.2	67.3	11.3	0.7	26.1	58.1	21.5
Queue Delay	0.0	0.0	0.0	0.0	0.0	0.0	0.0	0.0	0.0	0.0	0.0	0.0
Total Delay	60.2	27.0	9.0	22.2	30.3	0.2	67.3	11.3	0.7	26.1	58.1	21.5
Queue Length 50th (m)	4.7	61.4	10.6	33.8	212.0	0.0	16.6	8.4	0.2	1.3	169.1	26.5
Queue Length 95th (m)	#18.9	77.8	27.1	m35.6 m	#233.4	m0.0	#39.2	14.2	m0.3	4.8	#216.4	46.8
Internal Link Dist (m)		25.6		1983.6			461.7			82.4		
Turn Bay Length (m)	30.0		40.0	52.0		14.0	48.0		36.0	15.0		47.0
Base Capacity (vph)	54	1458	759	260	1558	748	157	1603	764	420	1332	638
Starvation Cap Reductn	0	0	0	0	0	0	0	0	0	0	0	0
Spillback Cap Reductn	0	0	0	0	0	0	0	0	0	0	0	0
Storage Cap Reductn	0	0	0	0	0	0	0	0	0	0	0	0
Reduced v/c Ratio	0.48	0.45	0.29	0.73	0.98	0.02	0.70	0.17	0.02	0.02	0.97	0.34

Intersection Summary
 Cycle Length: 130
 Actuated Cycle Length: 130
 Offset: 0 (0%), Referenced to phase 2:NBTL and 6:SBTL, Start of Green
 Natural Cycle: 120
 Control Type: Actuated-Coordinated
 # 95th percentile volume exceeds capacity, queue may be longer.
 Queue shown is maximum after two cycles.
 m Volume for 95th percentile queue is metered by upstream signal.

Splits and Phases: 1: Warden Avenue & Elgin Mills Road

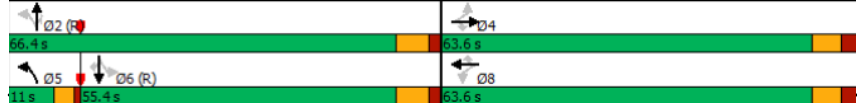

052314_bg2041_ Revised.syn
R.J. Burnside & Associates

Synchro 11 Report
03/23/2023 - Page 1

HCM Signalized Intersection Capacity Analysis
1: Warden Avenue & Elgin Mills Road

BG 2041 AM
Baseline

	EBL	EBT	EBR	WBL	WBT	WBR	NBL	NBT	NBR	SBL	SBT	SBR
Lane Configurations	↔	↔	↔	↔	↔	↔	↔	↔	↔	↔	↔	↔
Traffic Volume (vph)	24	606	200	176	1408	17	101	244	14	7	1185	199
Future Volume (vph)	24	606	200	176	1408	17	101	244	14	7	1185	199
Ideal Flow (vphpl)	1900	1900	1900	1900	1900	1900	1900	1900	1900	1900	1900	1900
Total Lost time (s)	7.0	7.0	7.0	7.0	7.0	7.0	4.0	7.0	7.0	7.0	7.0	7.0
Lane Util. Factor	1.00	0.95	1.00	1.00	0.95	1.00	1.00	0.95	1.00	1.00	0.95	1.00
Frt	1.00	1.00	0.85	1.00	1.00	0.85	1.00	1.00	0.85	1.00	1.00	0.85
Fit Protected	0.95	1.00	1.00	0.95	1.00	1.00	0.95	1.00	0.95	1.00	0.95	1.00
Satd. Flow (prot)	1690	3349	1555	1738	3579	1633	1789	3510	1633	1825	3579	1601
Fit Permitted	0.07	1.00	1.00	0.33	1.00	1.00	0.08	1.00	1.00	0.59	1.00	1.00
Satd. Flow (perm)	126	3349	1555	598	3579	1633	144	3510	1633	1130	3579	1601
Peak-hour factor, PHF	0.92	0.92	0.92	0.92	0.92	0.92	0.92	0.92	0.92	0.92	0.92	0.92
Adj. Flow (vph)	26	659	217	191	1530	18	110	265	15	8	1288	216
RTOR Reduction (vph)	0	0	82	0	0	10	0	8	0	0	42	0
Lane Group Flow (vph)	26	659	135	191	1530	8	110	265	7	8	1288	174
Heavy Vehicles (%)	8%	9%	5%	5%	2%	0%	2%	4%	0%	0%	2%	2%
Turn Type	Perm	NA	Perm	Perm	NA	Perm	pm+pt	NA	Perm	Perm	NA	Perm
Protected Phases		4			8		5	2			6	
Permitted Phases	4		4	8		8	2		2	6		6
Actuated Green, G (s)	56.6	56.6	56.6	56.6	56.6	56.6	59.4	59.4	59.4	48.4	48.4	48.4
Effective Green, g (s)	56.6	56.6	56.6	56.6	56.6	56.6	59.4	59.4	59.4	48.4	48.4	48.4
Actuated g/C Ratio	0.44	0.44	0.44	0.44	0.44	0.44	0.46	0.46	0.46	0.37	0.37	0.37
Clearance Time (s)	7.0	7.0	7.0	7.0	7.0	7.0	4.0	7.0	7.0	7.0	7.0	7.0
Vehicle Extension (s)	3.0	3.0	3.0	3.0	3.0	3.0	3.0	3.0	3.0	3.0	3.0	3.0
Lane Grp Cap (vph)	54	1458	677	260	1558	710	154	1603	746	420	1332	596
v/s Ratio Prot		0.20			c0.43		c0.04	0.08			c0.36	
v/s Ratio Perm	0.21		0.09	0.32		0.00	0.29		0.00	0.01		0.11
v/c Ratio	0.48	0.45	0.20	0.73	0.98	0.01	0.71	0.17	0.01	0.02	0.97	0.29
Uniform Delay, d1	26.2	25.8	22.7	30.5	36.2	20.8	29.5	20.7	19.3	25.8	40.0	28.7
Progression Factor	1.00	1.00	1.00	0.48	0.55	1.00	2.19	0.53	0.45	1.00	1.00	1.00
Incremental Delay, d2	6.6	0.2	0.1	3.4	9.1	0.0	14.5	0.2	0.0	0.1	17.9	1.2
Delay (s)	32.8	26.0	22.8	18.0	28.9	20.8	79.0	11.3	8.6	25.9	57.9	30.0
Level of Service	C	C	C	B	C	C	E	B	A	C	E	C
Approach Delay (s)		25.5			27.6		30.3				53.8	
Approach LOS		C			C		C				D	

Intersection Summary
 HCM 2000 Control Delay: 36.1
 HCM 2000 Level of Service: D
 HCM 2000 Volume to Capacity ratio: 0.96
 Actuated Cycle Length (s): 130.0
 Sum of lost time (s): 18.0
 Intersection Capacity Utilization: 120.6%
 ICU Level of Service: H
 Analysis Period (min): 15
 c Critical Lane Group

052314_bg2041_ Revised.syn
R.J. Burnside & Associates

Synchro 11 Report
03/23/2023 - Page 2

Timings
2: Warden Avenue & Major Mackenzie Drive East

BG 2041 AM
Baseline

	EBL	EBT	EBR	WBL	WBT	WBR	NBL	NBT	NBR	SBL	SBT	SBR
Lane Configurations	↔	↔↔	↔	↔	↔↔	↔	↔	↔↔	↔	↔	↔↔	↔
Traffic Volume (vph)	1	677	140	344	2037	24	65	675	64	74	2000	246
Future Volume (vph)	1	677	140	344	2037	24	65	675	64	74	2000	246
Lane Group Flow (vph)	1	728	151	370	2190	26	70	726	69	80	2151	265
Turn Type	Perm	NA	Perm	pm+pt	NA	Perm	pm+pt	NA	Perm	Perm	NA	Perm
Protected Phases		2		1	6		3	8			4	
Permitted Phases	2		2	6		6	8		8	4		4
Detector Phase	2	2	2	1	6	6	3	8	8	4	4	4
Switch Phase												
Minimum Initial (s)	30.0	30.0	30.0	7.0	30.0	30.0	7.0	10.0	10.0	10.0	10.0	10.0
Minimum Split (s)	47.5	47.5	47.5	11.0	47.5	47.5	11.0	41.5	41.5	41.5	41.5	41.5
Total Split (s)	51.0	51.0	51.0	13.0	64.0	64.0	12.0	66.0	66.0	54.0	54.0	54.0
Total Split (%)	39.2%	39.2%	39.2%	10.0%	49.2%	49.2%	9.2%	50.8%	50.8%	41.5%	41.5%	41.5%
Yellow Time (s)	5.0	5.0	5.0	3.0	5.0	5.0	3.0	4.5	4.5	4.5	4.5	4.5
All-Red Time (s)	2.5	2.5	2.5	1.0	2.5	2.5	1.0	3.0	3.0	3.0	3.0	3.0
Lost Time Adjust (s)	0.0	0.0	0.0	0.0	0.0	0.0	0.0	0.0	0.0	0.0	0.0	0.0
Total Lost Time (s)	7.5	7.5	7.5	4.0	7.5	7.5	4.0	7.5	7.5	7.5	7.5	7.5
Lead/Lag	Lag	Lag	Lag	Lead			Lead			Lag	Lag	Lag
Lead-Lag Optimize?	Yes	Yes	Yes	Yes			Yes			Yes	Yes	Yes
Recall Mode	C-Max	C-Max	C-Max	None	C-Max	C-Max	None	Max	Max	Max	Max	Max
v/c Ratio	0.02	0.65	0.26	1.36	1.43	0.04	0.45	0.47	0.11	0.34	1.61	0.40
Control Delay	30.0	40.0	12.0	202.0	232.9	6.3	27.8	26.2	4.8	28.4	307.1	15.9
Queue Delay	0.0	0.0	0.0	0.0	0.0	0.0	0.0	0.0	0.0	0.0	0.0	0.0
Total Delay	30.0	40.0	12.0	202.0	232.9	6.3	27.8	26.2	4.8	28.4	307.1	15.9
Queue Length 50th (m)	0.2	83.1	8.1	~112.1	~392.4	0.0	9.6	67.0	0.0	16.0	~436.0	34.8
Queue Length 95th (m)	1.6	104.3	23.7	m#67.6	m#238.5	m0.0	18.1	83.9	8.1	m17.4	m#467.7	m37.7
Internal Link Dist (m)		76.9		1995.6			120.3			372.3		
Turn Bay Length (m)	109.0		33.0	80.0		35.0	72.0		83.0	28.0		57.0
Base Capacity (vph)	59	1126	583	272	1536	734	160	1544	647	235	1332	667
Starvation Cap Reductn	0	0	0	0	0	0	0	0	0	0	0	0
Spillback Cap Reductn	0	0	0	0	0	0	0	0	0	0	0	0
Storage Cap Reductn	0	0	0	0	0	0	0	0	0	0	0	0
Reduced v/c Ratio	0.02	0.65	0.26	1.36	1.43	0.04	0.44	0.47	0.11	0.34	1.61	0.40

Intersection Summary

Cycle Length: 130
 Actuated Cycle Length: 130
 Offset: 0 (0%), Referenced to phase 2:EBTL and 6:WBTL, Start of Green
 Natural Cycle: 145
 Control Type: Actuated-Coordinated
 ~ Volume exceeds capacity, queue is theoretically infinite.
 Queue shown is maximum after two cycles.
 # 95th percentile volume exceeds capacity, queue may be longer.
 Queue shown is maximum after two cycles.
 m Volume for 95th percentile queue is metered by upstream signal.

Splits and Phases: 2: Warden Avenue & Major Mackenzie Drive East

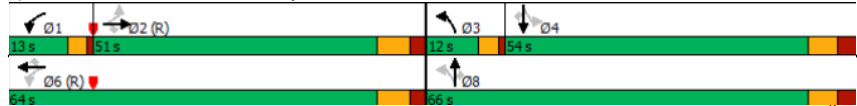

HCM Signalized Intersection Capacity Analysis
2: Warden Avenue & Major Mackenzie Drive East

BG 2041 AM
Baseline

	EBL	EBT	EBR	WBL	WBT	WBR	NBL	NBT	NBR	SBL	SBT	SBR
Lane Configurations	↔	↔↔	↔	↔	↔↔	↔	↔	↔↔	↔	↔	↔↔	↔
Traffic Volume (vph)	1	677	140	344	2037	24	65	675	64	74	2000	246
Future Volume (vph)	1	677	140	344	2037	24	65	675	64	74	2000	246
Lane Group Flow (vph)	1900	1900	1900	1900	1900	1900	1900	1900	1900	1900	1900	1900
Lane Width	3.5	3.5	3.5	3.5	3.5	3.5	3.5	3.5	3.5	3.5	3.5	3.5
Total Lost time (s)	7.5	7.5	7.5	4.0	7.5	7.5	4.0	7.5	7.5	7.5	7.5	7.5
Lane Util. Factor	1.00	0.95	1.00	1.00	0.95	1.00	1.00	0.95	1.00	1.00	0.95	1.00
Frt	1.00	1.00	0.85	1.00	1.00	0.85	1.00	1.00	0.85	1.00	1.00	0.85
Fit Protected	0.95	1.00	1.00	0.95	1.00	1.00	0.95	1.00	1.00	0.95	1.00	1.00
Satd. Flow (prot)	1785	3368	1536	1733	3535	1597	1700	3433	1353	1623	3535	1597
Fit Permitted	0.09	1.00	1.00	0.21	1.00	1.00	0.08	1.00	1.00	0.37	1.00	1.00
Satd. Flow (perm)	176	3368	1536	390	3535	1597	135	3433	1353	625	3535	1597
Peak-hour factor, PHF	0.93	0.93	0.93	0.93	0.93	0.93	0.93	0.93	0.93	0.93	0.93	0.93
Adj. Flow (vph)	1	728	151	370	2190	26	70	726	69	80	2151	265
RTOR Reduction (vph)	0	0	71	0	0	15	0	0	38	0	0	65
Lane Group Flow (vph)	1	728	80	370	2190	11	70	726	31	80	2151	200
Heavy Vehicles (%)	0%	6%	4%	3%	1%	0%	5%	4%	18%	10%	1%	0%
Turn Type	Perm	NA	Perm	pm+pt	NA	Perm	pm+pt	NA	Perm	Perm	NA	Perm
Protected Phases		2		1	6		3	8			4	
Permitted Phases	2		2	6		6	8		8	4		4
Actuated Green, G (s)	42.7	42.7	42.7	55.7	55.7	55.7	59.3	59.3	59.3	49.0	49.0	49.0
Effective Green, g (s)	42.7	42.7	42.7	55.7	55.7	55.7	59.3	59.3	59.3	49.0	49.0	49.0
Actuated g/C Ratio	0.33	0.33	0.33	0.43	0.43	0.43	0.46	0.46	0.46	0.38	0.38	0.38
Clearance Time (s)	7.5	7.5	7.5	4.0	7.5	7.5	4.0	7.5	7.5	7.5	7.5	7.5
Vehicle Extension (s)	3.0	3.0	3.0	3.0	3.0	3.0	3.0	3.0	3.0	3.0	3.0	3.0
Lane Grp Cap (vph)	57	1106	504	260	1514	684	137	1565	617	235	1332	601
v/s Ratio Prot		0.22		0.10	c0.62		0.02	c0.21			c0.61	
v/s Ratio Perm	0.01	0.05	0.51		0.01	0.21		0.02	0.13		0.12	
v/c Ratio	0.02	0.66	0.16	1.42	1.45	0.02	0.51	0.46	0.05	0.34	1.61	0.33
Uniform Delay, d1	29.5	37.4	30.9	34.2	37.1	21.4	29.7	24.4	19.7	28.9	40.5	28.8
Progression Factor	1.00	1.00	1.00	1.87	1.57	1.00	1.00	1.00	1.00	0.85	0.98	0.83
Incremental Delay, d2	0.6	3.1	0.7	192.5	201.3	0.0	3.2	1.0	0.2	1.5	278.1	0.6
Delay (s)	30.0	40.5	31.6	256.3	259.7	21.4	32.9	25.4	19.8	26.1	317.8	24.5
Level of Service	C	D	C	F	F	C	C	C	B	C	F	C
Approach Delay (s)		38.9			256.8			25.5			277.3	
Approach LOS		D			F			C			F	

Intersection Summary

HCM 2000 Control Delay: 206.9, HCM 2000 Level of Service: F
 HCM 2000 Volume to Capacity ratio: 1.53
 Actuated Cycle Length (s): 130.0, Sum of lost time (s): 23.0
 Intersection Capacity Utilization: 161.6%, ICU Level of Service: H
 Analysis Period (min): 15
 c Critical Lane Group

Timings
3: Kennedy Road & Elgin Mills Road

BG 2041 AM
Baseline

	EBL	EBT	EBR	WBL	WBT	WBR	NBL	NBT	NBR	SBL	SBT
Lane Configurations	↔	↕↕	↔	↔	↕↕	↔	↔	↕	↔	↔	↕↕
Traffic Volume (vph)	14	364	110	81	1218	14	149	375	9	17	922
Future Volume (vph)	14	364	110	81	1218	14	149	375	9	17	922
Lane Group Flow (vph)	18	455	138	101	1523	18	186	469	11	21	1286
Turn Type	Perm	NA	Perm	Perm	NA	Perm	pm+pt	NA	Perm	Perm	NA
Protected Phases		4			8		5	2			6
Permitted Phases	4		4	8		8	2		2	6	
Detector Phase	4	4	4	8	8	8	5	2	2	6	6
Switch Phase											
Minimum Initial (s)	10.0	10.0	10.0	10.0	10.0	10.0	5.0	30.0	30.0	40.0	40.0
Minimum Split (s)	30.0	30.0	30.0	30.0	30.0	30.0	12.5	47.5	47.5	47.5	47.5
Total Split (s)	64.0	64.0	64.0	64.0	64.0	64.0	14.0	66.0	66.0	52.0	52.0
Total Split (%)	49.2%	49.2%	49.2%	49.2%	49.2%	49.2%	10.8%	50.8%	50.8%	40.0%	40.0%
Yellow Time (s)	4.0	4.0	4.0	4.0	4.0	4.0	3.0	5.0	5.0	5.0	5.0
All-Red Time (s)	3.0	3.0	3.0	3.0	3.0	3.0	1.0	2.5	2.5	2.5	2.5
Lost Time Adjust (s)	0.0	0.0	0.0	0.0	0.0	0.0	0.0	0.0	0.0	0.0	0.0
Total Lost Time (s)	7.0	7.0	7.0	7.0	7.0	7.0	4.0	7.5	7.5	7.5	7.5
Lead/Lag							Lead			Lag	Lag
Lead-Lag Optimize?							Yes			Yes	Yes
Recall Mode	None	None	None	None	None	None	None	C-Max	C-Max	C-Max	C-Max
v/c Ratio	0.31	0.29	0.18	0.27	0.96	0.02	0.89	0.54	0.01	0.07	1.04
Control Delay	19.6	3.5	1.3	25.7	50.6	0.1	92.1	14.9	1.3	29.8	77.7
Queue Delay	0.0	0.0	0.0	0.0	0.0	0.0	0.0	0.0	0.0	0.0	0.0
Total Delay	19.6	3.5	1.3	25.7	50.6	0.1	92.1	14.9	1.3	29.8	77.7
Queue Length 50th (m)	0.3	5.5	0.3	16.2	194.5	0.0	37.5	40.0	0.1	3.6	~186.3
Queue Length 95th (m)	m0.0	5.1	0.3	25.7	187.2	0.0	#59.8	49.1	0.0	8.7	#183.7
Internal Link Dist (m)		1983.6			47.6			491.8			90.6
Turn Bay Length (m)	30.0		31.0	30.0		14.0	61.0		30.0	15.0	
Base Capacity (vph)	59	1600	793	381	1600	755	209	871	759	302	1238
Starvation Cap Reductn	0	0	0	0	0	0	0	0	0	0	0
Spillback Cap Reductn	0	0	0	0	0	0	0	0	0	0	0
Storage Cap Reductn	0	0	0	0	0	0	0	0	0	0	0
Reduced v/c Ratio	0.31	0.28	0.17	0.27	0.95	0.02	0.89	0.54	0.01	0.07	1.04

Intersection Summary

Cycle Length: 130
 Actuated Cycle Length: 130
 Offset: 0 (0%), Referenced to phase 2:NBTL and 6:SBTL, Start of Green
 Natural Cycle: 120
 Control Type: Actuated-Coordinated
 ~ Volume exceeds capacity, queue is theoretically infinite.
 Queue shown is maximum after two cycles.
 # 95th percentile volume exceeds capacity, queue may be longer.
 Queue shown is maximum after two cycles.
 m Volume for 95th percentile queue is metered by upstream signal.

Splits and Phases: 3: Kennedy Road & Elgin Mills Road

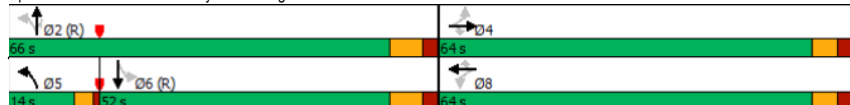

HCM Signalized Intersection Capacity Analysis
3: Kennedy Road & Elgin Mills Road

BG 2041 AM
Baseline

	EBL	EBT	EBR	WBL	WBT	WBR	NBL	NBT	NBR	SBL	SBT	SBR
Lane Configurations	↔	↕↕	↔	↔	↕↕	↔	↔	↕	↔	↔	↕↕	
Traffic Volume (vph)	14	364	110	81	1218	14	149	375	9	17	922	106
Future Volume (vph)	14	364	110	81	1218	14	149	375	9	17	922	106
Ideal Flow (vphpl)	1900	1900	1900	1900	1900	1900	1900	1900	1900	1900	1900	1900
Total Lost time (s)	7.0	7.0	7.0	7.0	7.0	7.0	4.0	7.5	7.5	7.5	7.5	
Lane Util. Factor	1.00	0.95	1.00	1.00	0.95	1.00	1.00	1.00	1.00	1.00	0.95	
Frt	1.00	1.00	0.85	1.00	1.00	0.85	1.00	1.00	0.85	1.00	0.98	
Fit Protected	0.95	1.00	1.00	0.95	1.00	1.00	0.95	1.00	1.00	0.95	1.00	
Satd. Flow (prot)	1825	3650	1633	1825	3650	1633	1825	1921	1633	1825	3593	
Fit Permitted	0.07	1.00	1.00	0.45	1.00	1.00	0.08	1.00	1.00	0.46	1.00	
Satd. Flow (perm)	136	3650	1633	869	3650	1633	158	1921	1633	883	3593	
Peak-hour factor, PHF	0.80	0.80	0.80	0.80	0.80	0.80	0.80	0.80	0.80	0.80	0.80	0.80
Adj. Flow (vph)	18	455	138	101	1522	18	186	469	11	21	1152	132
RTOR Reduction (vph)	0	0	78	0	0	10	0	6	0	7	0	
Lane Group Flow (vph)	18	455	60	101	1523	8	186	469	5	21	1279	0
Heavy Vehicles (%)	0%	0%	0%	0%	0%	0%	0%	0%	0%	0%	0%	0%
Turn Type	Perm	NA	Perm	Perm	NA	Perm	pm+pt	NA	Perm	Perm	NA	
Protected Phases		4			8		5	2			6	
Permitted Phases	4		4	8		8	2		2	6		
Actuated Green, G (s)	56.5	56.5	56.5	56.5	56.5	56.5	59.0	59.0	59.0	44.6	44.6	
Effective Green, g (s)	56.5	56.5	56.5	56.5	56.5	56.5	59.0	59.0	59.0	44.6	44.6	
Actuated g/C Ratio	0.43	0.43	0.43	0.43	0.43	0.43	0.45	0.45	0.45	0.34	0.34	
Clearance Time (s)	7.0	7.0	7.0	7.0	7.0	7.0	4.0	7.5	7.5	7.5	7.5	
Vehicle Extension (s)	3.0	3.0	3.0	3.0	3.0	3.0	3.0	3.0	3.0	3.0	3.0	
Lane Grp Cap (vph)	59	1586	709	377	1586	709	205	871	741	302	1232	
v/s Ratio Prot		0.12			c0.42		c0.07	0.24			c0.36	
v/s Ratio Perm	0.13		0.04	0.12		0.00	0.34		0.00	0.02		
v/c Ratio	0.31	0.29	0.08	0.27	0.96	0.01	0.91	0.54	0.01	0.07	1.04	
Uniform Delay, d1	24.0	23.7	21.6	23.5	35.7	20.9	34.5	25.7	19.4	28.7	42.7	
Progression Factor	0.27	0.13	0.25	1.00	1.00	1.00	2.06	0.48	1.00	1.00	1.00	
Incremental Delay, d2	2.7	0.1	0.0	0.4	14.3	0.0	37.7	2.4	0.0	0.4	36.2	
Delay (s)	9.2	3.2	5.5	23.9	49.9	20.9	108.9	14.6	19.5	29.2	78.9	
Level of Service	A	A	A	C	D	C	F	B	B	C	E	
Approach Delay (s)		3.9			48.0		41.0				78.1	
Approach LOS		A			D		D				E	

Intersection Summary

HCM 2000 Control Delay: 49.8
 HCM 2000 Level of Service: D
 HCM 2000 Volume to Capacity ratio: 0.99
 Actuated Cycle Length (s): 130.0
 Sum of lost time (s): 18.5
 Intersection Capacity Utilization: 124.5%
 ICU Level of Service: H
 Analysis Period (min): 15
 c Critical Lane Group

Timings
4: Kennedy Road & Major Mackenzie Drive East

BG 2041 AM
Baseline

	EBL	EBT	EBR	WBL	WBT	WBR	NBL	NBT	NBR	SBL	SBT	SBR
Lane Configurations	↔	↔↔	↔	↔	↔↔	↔	↔	↔↔	↔	↔	↔↔	↔
Traffic Volume (vph)	35	633	249	179	2048	173	275	405	100	90	1158	155
Future Volume (vph)	35	633	249	179	2048	173	275	405	100	90	1158	155
Lane Group Flow (vph)	38	696	274	197	2251	190	302	445	110	99	1273	170
Turn Type	pm+pt	NA	Perm	pm+pt	NA	Perm	pm+pt	NA	Perm	Perm	NA	Perm
Protected Phases	5	2		1	6		3	8			4	
Permitted Phases	2		2	6		6	8		8	4		4
Detector Phase	5	2	2	1	6	6	3	8	8	4	4	4
Switch Phase												
Minimum Initial (s)	7.0	30.0	30.0	7.0	30.0	30.0	7.0	10.0	10.0	10.0	10.0	10.0
Minimum Split (s)	11.0	47.5	47.5	11.0	47.5	47.5	11.0	38.5	38.5	38.5	38.5	38.5
Total Split (s)	12.0	63.0	63.0	12.0	63.0	63.0	15.0	55.0	55.0	40.0	40.0	40.0
Total Split (%)	9.2%	48.5%	48.5%	9.2%	48.5%	48.5%	11.5%	42.3%	42.3%	30.8%	30.8%	30.8%
Yellow Time (s)	3.0	5.0	5.0	3.0	5.0	5.0	3.0	5.0	5.0	5.0	5.0	5.0
All-Red Time (s)	1.0	2.5	2.5	1.0	2.5	2.5	1.0	2.5	2.5	2.5	2.5	2.5
Lost Time Adjust (s)	0.0	0.0	0.0	0.0	0.0	0.0	0.0	0.0	0.0	0.0	0.0	0.0
Total Lost Time (s)	4.0	7.5	7.5	4.0	7.5	7.5	4.0	7.5	7.5	7.5	7.5	7.5
Lead/Lag	Lead	Lag	Lag	Lead	Lag	Lag	Lead			Lag	Lag	Lag
Lead-Lag Optimize?	Yes	Yes	Yes	Yes	Yes	Yes	Yes			Yes	Yes	Yes
Recall Mode	None	C-Max	C-Max	None	C-Max	C-Max	None	Max	Max	Max	Max	Max
v/c Ratio	0.23	0.45	0.33	0.53	1.37	0.24	1.38	0.33	0.17	0.42	1.40	0.35
Control Delay	27.1	29.2	8.6	21.2	202.2	11.3	223.8	30.7	5.5	37.8	213.1	14.4
Queue Delay	0.0	0.0	0.0	0.0	0.0	0.0	0.0	0.0	0.0	0.0	0.0	0.0
Total Delay	27.1	29.2	8.6	21.2	202.2	11.3	223.8	30.7	5.5	37.8	213.1	14.4
Queue Length 50th (m)	3.6	49.9	3.3	24.7	~408.3	12.8	~85.2	43.1	0.0	10.8	~222.7	0.3
Queue Length 95th (m)	m10.2	72.1	27.7	38.1	#452.8	28.7	#142.0	56.8	12.0	28.9	#267.6	25.1
Internal Link Dist (m)		1995.6			145.1			116.0			395.2	
Turn Bay Length (m)	30.0		58.0	42.0		40.0	142.0		39.0	53.0		36.0
Base Capacity (vph)	174	1558	843	375	1640	781	219	1333	666	237	912	481
Starvation Cap Reductn	0	0	0	0	0	0	0	0	0	0	0	0
Spillback Cap Reductn	0	0	0	0	0	0	0	0	0	0	0	0
Storage Cap Reductn	0	0	0	0	0	0	0	0	0	0	0	0
Reduced v/c Ratio	0.22	0.45	0.33	0.53	1.37	0.24	1.38	0.33	0.17	0.42	1.40	0.35

Intersection Summary
 Cycle Length: 130
 Actuated Cycle Length: 130
 Offset: 65 (50%), Referenced to phase 2:EBTL and 6:WBTL, Start of Green
 Natural Cycle: 150
 Control Type: Actuated-Coordinated
 ~ Volume exceeds capacity, queue is theoretically infinite.
 Queue shown is maximum after two cycles.
 # 95th percentile volume exceeds capacity, queue may be longer.
 Queue shown is maximum after two cycles.
 m Volume for 95th percentile queue is metered by upstream signal.

Splits and Phases: 4: Kennedy Road & Major Mackenzie Drive East

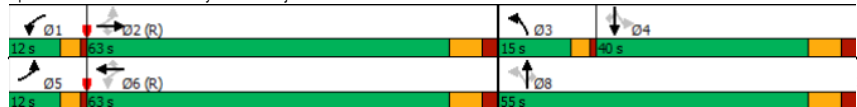

HCM Signalized Intersection Capacity Analysis
4: Kennedy Road & Major Mackenzie Drive East

BG 2041 AM
Baseline

	EBL	EBT	EBR	WBL	WBT	WBR	NBL	NBT	NBR	SBL	SBT	SBR
Lane Configurations	↔	↔↔	↔	↔	↔↔	↔	↔	↔↔	↔	↔	↔↔	↔
Traffic Volume (vph)	35	633	249	179	2048	173	275	405	100	90	1158	155
Future Volume (vph)	35	633	249	179	2048	173	275	405	100	90	1158	155
Ideal Flow (vphpl)	1900	1900	1900	1900	1900	1900	1900	1900	1900	1900	1900	1900
Total Lost time (s)	4.0	7.5	7.5	4.0	7.5	7.5	4.0	7.5	7.5	7.5	7.5	7.5
Lane Util. Factor	1.00	0.95	1.00	1.00	0.95	1.00	1.00	0.95	1.00	1.00	0.95	1.00
Frbp, ped/bikes	1.00	1.00	0.99	1.00	1.00	0.99	1.00	1.00	1.00	1.00	1.00	0.99
Frlpb, ped/bikes	1.00	1.00	1.00	1.00	1.00	1.00	1.00	1.00	1.00	1.00	1.00	1.00
Frt	1.00	1.00	0.85	1.00	1.00	0.85	1.00	1.00	0.85	1.00	1.00	0.85
Fit Protected	0.95	1.00	1.00	0.95	1.00	1.00	0.95	1.00	1.00	0.95	1.00	1.00
Satd. Flow (prot)	1825	3650	1609	1825	3650	1609	1825	3650	1633	1825	3650	1611
Fit Permitted	0.07	1.00	1.00	0.30	1.00	1.00	0.11	1.00	1.00	0.49	1.00	1.00
Satd. Flow (perm)	138	3650	1609	567	3650	1609	211	3650	1633	950	3650	1611
Peak-hour factor, PHF	0.91	0.91	0.91	0.91	0.91	0.91	0.91	0.91	0.91	0.91	0.91	0.91
Adj. Flow (vph)	38	696	274	197	2251	190	302	445	110	99	1273	170
RTOR Reduction (vph)	0	0	157	0	0	58	0	0	70	0	0	79
Lane Group Flow (vph)	38	696	117	197	2251	132	302	445	40	99	1273	91
Confl. Peds. (#/hr)	2		2	2		2	1					1
Heavy Vehicles (%)	0%	0%	0%	0%	0%	0%	0%	0%	0%	0%	0%	0%
Turn Type	pm+pt	NA	Perm	pm+pt	NA	Perm	pm+pt	NA	Perm	Perm	NA	Perm
Protected Phases	5	2		1	6		3	8			4	
Permitted Phases	2		2	6		6	8		8	4		4
Actuated Green, G (s)	61.4	55.5	55.5	65.6	57.6	57.6	47.5	47.5	47.5	32.5	32.5	32.5
Effective Green, g (s)	61.4	55.5	55.5	65.6	57.6	57.6	47.5	47.5	47.5	32.5	32.5	32.5
Actuated g/C Ratio	0.47	0.43	0.43	0.50	0.44	0.44	0.37	0.37	0.37	0.25	0.25	0.25
Clearance Time (s)	4.0	7.5	7.5	4.0	7.5	7.5	4.0	7.5	7.5	7.5	7.5	7.5
Vehicle Extension (s)	3.0	6.0	6.0	3.0	6.0	6.0	3.0	6.0	3.0	3.0	3.0	3.0
Lane Grp Cap (vph)	141	1558	686	363	1617	712	213	1333	596	237	912	402
v/s Ratio Prot	0.01	0.19		c0.03	c0.62		c0.12	0.12			0.35	
v/s Ratio Perm	0.11		0.07	0.24		0.08	c0.40		0.02	0.10		0.06
v/c Ratio	0.27	0.45	0.17	0.54	1.39	0.18	1.42	0.33	0.07	0.42	1.40	0.23
Uniform Delay, d1	28.9	26.4	23.0	18.9	36.2	22.0	34.5	29.8	26.8	40.8	48.8	38.8
Progression Factor	1.74	1.07	2.93	1.00	1.00	1.00	1.00	1.00	1.00	0.79	0.68	0.78
Incremental Delay, d2	0.9	0.8	0.5	1.7	180.3	0.6	213.3	0.7	0.2	4.7	184.0	1.2
Delay (s)	51.1	29.0	67.9	20.5	216.5	22.5	247.8	30.5	27.1	36.9	217.0	31.5
Level of Service	D	C	E	C	F	C	F	C	C	D	F	C
Approach Delay (s)		40.4			187.9		106.6				185.0	
Approach LOS		D			F		F				F	

Intersection Summary
 HCM 2000 Control Delay: 151.0
 HCM 2000 Level of Service: F
 HCM 2000 Volume to Capacity ratio: 1.40
 Actuated Cycle Length (s): 130.0
 Sum of lost time (s): 23.0
 Intersection Capacity Utilization: 128.9%
 ICU Level of Service: H
 Analysis Period (min): 15
 c Critical Lane Group

Timings
5: Warden Avenue & E-W1

BG 2041 AM
Baseline

	EBL	EBT	EBR	WBL	WBT	NBL	NBT	NBR	SBL	SBT	SBR
Lane Configurations	↔	↔	↔	↔	↔	↔	↔	↔	↔	↔	↔
Traffic Volume (vph)	16	157	200	84	205	175	317	82	15	1537	9
Future Volume (vph)	16	157	200	84	205	175	317	82	15	1537	9
Lane Group Flow (vph)	17	171	217	91	251	190	345	89	16	1671	10
Turn Type	Perm	NA	Perm	pm+pt	NA	pm+pt	NA	Perm	Perm	NA	Perm
Protected Phases		4		3	8	5	2		6		6
Permitted Phases	4		4	8		2		2	6		6
Detector Phase	4	4	4	3	8	5	2	2	6	6	6
Switch Phase											
Minimum Initial (s)	10.0	10.0	10.0	7.0	10.0	7.0	30.0	30.0	30.0	30.0	30.0
Minimum Split (s)	33.5	33.5	33.5	11.0	33.5	11.0	37.5	37.5	37.5	37.5	37.5
Total Split (s)	33.5	33.5	33.5	11.0	44.5	13.0	85.5	85.5	72.5	72.5	72.5
Total Split (%)	25.8%	25.8%	25.8%	8.5%	34.2%	10.0%	65.8%	65.8%	55.8%	55.8%	55.8%
Yellow Time (s)	5.0	5.0	5.0	3.0	5.0	3.0	5.0	5.0	5.0	5.0	5.0
All-Red Time (s)	2.5	2.5	2.5	1.0	2.5	1.0	2.5	2.5	2.5	2.5	2.5
Lost Time Adjust (s)	0.0	0.0	0.0	0.0	0.0	0.0	0.0	0.0	0.0	0.0	0.0
Total Lost Time (s)	7.5	7.5	7.5	4.0	7.5	4.0	7.5	7.5	7.5	7.5	7.5
Lead/Lag	Lag	Lag	Lag	Lead		Lead			Lag	Lag	Lag
Lead-Lag Optimize?	Yes	Yes	Yes	Yes		Yes			Yes	Yes	Yes
Recall Mode	None	None	None	None	None	None	C-Max	C-Max	C-Max	C-Max	C-Max
v/c Ratio	0.11	0.69	0.60	0.39	0.62	0.69	0.14	0.08	0.03	0.90	0.01
Control Delay	49.1	68.1	19.1	43.0	51.8	50.1	22.6	16.1	17.1	25.6	0.0
Queue Delay	0.0	0.0	0.0	0.0	0.0	0.0	0.0	0.0	0.0	0.0	0.0
Total Delay	49.1	68.1	19.1	43.0	51.8	50.1	22.6	16.1	17.1	25.6	0.0
Queue Length 50th (m)	3.9	42.5	9.5	18.7	57.6	42.8	40.1	13.3	1.6	97.0	0.0
Queue Length 95th (m)	10.7	63.2	33.0	31.4	80.4	#75.0	41.7	21.2	m2.1	m109.4	m0.0
Internal Link Dist (m)		159.8			139.6		371.1			461.7	
Turn Bay Length (m)	30.0		73.0	48.0		80.0		34.0	48.0		30.0
Base Capacity (vph)	227	376	461	235	530	276	2393	1100	530	1850	878
Starvation Cap Reductn	0	0	0	0	0	0	0	0	0	0	0
Spillback Cap Reductn	0	0	0	0	0	0	0	0	0	0	0
Storage Cap Reductn	0	0	0	0	0	0	0	0	0	0	0
Reduced v/c Ratio	0.07	0.45	0.47	0.39	0.47	0.69	0.14	0.08	0.03	0.90	0.01

Intersection Summary

Cycle Length: 130
 Actuated Cycle Length: 130
 Offset: 0 (0%), Referenced to phase 2:NBTL and 6:SBTL, Start of Green
 Natural Cycle: 115
 Control Type: Actuated-Coordinated
 # 95th percentile volume exceeds capacity, queue may be longer.
 Queue shown is maximum after two cycles.
 m Volume for 95th percentile queue is metered by upstream signal.

Splits and Phases: 5: Warden Avenue & E-W1



052314_bg2041_Revised.syn
 R.J. Burnside & Associates

Synchro 11 Report
 03/23/2023 - Page 9

HCM Signalized Intersection Capacity Analysis
5: Warden Avenue & E-W1

BG 2041 AM
Baseline

	EBL	EBT	EBR	WBL	WBT	WBR	NBL	NBT	NBR	SBL	SBT	SBR
Lane Configurations	↔	↔	↔	↔	↔	↔	↔	↔	↔	↔	↔	↔
Traffic Volume (vph)	16	157	200	84	205	26	175	317	82	15	1537	9
Future Volume (vph)	16	157	200	84	205	26	175	317	82	15	1537	9
Ideal Flow (vphpl)	1900	1900	1900	1900	1900	1900	1900	1900	1900	1900	1900	1900
Total Lost time (s)	7.5	7.5	7.5	4.0	7.5		4.0	7.5	7.5	7.5	7.5	7.5
Lane Util. Factor	1.00	1.00	1.00	1.00	1.00		1.00	0.95	1.00	1.00	0.95	1.00
Fr't	1.00	1.00	0.85	1.00	0.98		1.00	1.00	0.85	1.00	1.00	0.85
Fit Protected	0.95	1.00	1.00	0.95	1.00		0.95	1.00	1.00	0.95	1.00	1.00
Satd. Flow (prot)	1789	1883	1601	1789	1852		1789	3579	1601	1789	3579	1601
Fit Permitted	0.60	1.00	1.00	0.39	1.00		0.06	1.00	1.00	0.54	1.00	1.00
Satd. Flow (perm)	1137	1883	1601	739	1852		106	3579	1601	1026	3579	1601
Peak-hour factor, PHF	0.92	0.92	0.92	0.92	0.92	0.92	0.92	0.92	0.92	0.92	0.92	0.92
Adj. Flow (vph)	17	171	217	91	223	28	190	345	89	16	1671	10
RTOR Reduction (vph)	0	0	153	0	4	0	0	0	30	0	0	5
Lane Group Flow (vph)	17	171	64	91	247	0	190	345	59	16	1671	5
Turn Type	Perm	NA	Perm	pm+pt	NA		pm+pt	NA	Perm	Perm	NA	Perm
Protected Phases		4		3	8		5	2		6		6
Permitted Phases	4		4	8			2		2	6		6
Actuated Green, G (s)	17.1	17.1	17.1	28.1	28.1		86.9	86.9	86.9	67.2	67.2	67.2
Effective Green, g (s)	17.1	17.1	17.1	28.1	28.1		86.9	86.9	86.9	67.2	67.2	67.2
Actuated g/C Ratio	0.13	0.13	0.13	0.22	0.22		0.67	0.67	0.67	0.52	0.52	0.52
Clearance Time (s)	7.5	7.5	7.5	4.0	7.5		4.0	7.5	7.5	7.5	7.5	7.5
Vehicle Extension (s)	3.0	3.0	3.0	3.0	3.0		3.0	3.0	3.0	3.0	3.0	3.0
Lane Grp Cap (vph)	149	247	210	216	400		274	2392	1070	530	1850	827
v/s Ratio Prot		0.09		0.02	c0.13		c0.08	0.10			c0.47	
v/s Ratio Perm	0.01		0.04	0.07			0.38		0.04	0.02		0.00
v/c Ratio	0.11	0.69	0.31	0.42	0.62		0.69	0.14	0.06	0.03	0.90	0.01
Uniform Delay, d1	49.8	53.9	51.1	42.4	46.1		37.4	7.9	7.4	15.4	28.5	15.2
Progression Factor	1.00	1.00	1.00	1.00	1.00		1.30	2.67	8.59	1.02	0.72	1.00
Incremental Delay, d2	0.3	8.1	0.8	1.3	2.8		7.2	0.1	0.1	0.1	4.1	0.0
Delay (s)	50.1	62.1	51.9	43.7	48.9		55.7	21.2	63.9	15.8	24.6	15.2
Level of Service	D	E	D	D	D		E	C	E	B	C	B
Approach Delay (s)		56.1			47.5			37.8			24.5	
Approach LOS		E			D			D			C	

Intersection Summary

HCM 2000 Control Delay: 33.9, HCM 2000 Level of Service: C
 HCM 2000 Volume to Capacity ratio: 0.83
 Actuated Cycle Length (s): 130.0, Sum of lost time (s): 23.0
 Intersection Capacity Utilization: 95.7%, ICU Level of Service: F
 Analysis Period (min): 15
 c Critical Lane Group

052314_bg2041_Revised.syn
 R.J. Burnside & Associates

Synchro 11 Report
 03/23/2023 - Page 10

Timings
6: Warden Avenue & E-W2

BG 2041 AM
Baseline

	EBL	EBT	WBL	WBT	NBL	NBT	NBR	SBL	SBT	SBR
Lane Configurations	↔	↔	↔	↔	↔	↔	↔	↔	↔	↔
Traffic Volume (vph)	10	97	84	42	58	556	50	2	1809	10
Future Volume (vph)	10	97	84	42	58	556	50	2	1809	10
Lane Group Flow (vph)	11	295	91	55	63	604	54	2	1966	11
Turn Type	Perm	NA	pm+pt	NA	pm+pt	NA	Perm	Perm	NA	Perm
Protected Phases		4	3	8	5	2			6	
Permitted Phases	4		8		2		2	6		6
Detector Phase	4	4	3	8	5	2	2	6	6	6
Switch Phase										
Minimum Initial (s)	10.0	10.0	7.0	10.0	7.0	30.0	30.0	30.0	30.0	30.0
Minimum Split (s)	33.5	33.5	11.0	33.5	11.0	37.5	37.5	37.5	37.5	37.5
Total Split (s)	33.5	33.5	11.0	44.5	11.0	85.5	85.5	74.5	74.5	74.5
Total Split (%)	25.8%	25.8%	8.5%	34.2%	8.5%	65.8%	65.8%	57.3%	57.3%	57.3%
Yellow Time (s)	5.0	5.0	3.0	5.0	3.0	5.0	5.0	5.0	5.0	5.0
All-Red Time (s)	2.5	2.5	1.0	2.5	1.0	2.5	2.5	2.5	2.5	2.5
Lost Time Adjust (s)	0.0	0.0	0.0	0.0	0.0	0.0	0.0	0.0	0.0	0.0
Total Lost Time (s)	7.5	7.5	4.0	7.5	4.0	7.5	7.5	7.5	7.5	7.5
Lead/Lag	Lag	Lag	Lead		Lead		Lag	Lag	Lag	
Lead-Lag Optimize?	Yes	Yes	Yes		Yes		Yes	Yes	Yes	
Recall Mode	None	None	None	None	None	C-Max	C-Max	C-Max	C-Max	C-Max
v/c Ratio	0.05	0.86	0.51	0.12	0.41	0.27	0.05	0.00	0.98	0.01
Control Delay	43.2	64.3	44.7	31.1	42.8	4.6	1.6	19.5	37.4	0.0
Queue Delay	0.0	0.0	0.0	0.0	0.0	0.0	0.0	0.0	0.0	0.0
Total Delay	43.2	64.3	44.7	31.1	42.8	4.6	1.6	19.5	37.4	0.0
Queue Length 50th (m)	2.4	58.4	17.4	9.1	8.4	0.7	0.0	0.2	-277.6	0.0
Queue Length 95th (m)	7.7	#95.2	30.4	19.2	21.6	22.7	1.4	m0.2	#328.8	m0.0
Internal Link Dist (m)		167.0		182.8		414.0			371.1	
Turn Bay Length (m)	30.0		31.0		26.0		30.0	15.0		30.0
Base Capacity (vph)	271	390	178	528	155	2251	1033	447	2008	944
Starvation Cap Reductn	0	0	0	0	0	0	0	0	0	0
Spillback Cap Reductn	0	0	0	0	0	0	0	0	0	0
Storage Cap Reductn	0	0	0	0	0	0	0	0	0	0
Reduced v/c Ratio	0.04	0.76	0.51	0.10	0.41	0.27	0.05	0.00	0.98	0.01

Intersection Summary

Cycle Length: 130
 Actuated Cycle Length: 130
 Offset: 0 (0%), Referenced to phase 2:NBTL and 6:SBTL, Start of Green
 Natural Cycle: 135
 Control Type: Actuated-Coordinated
 ~ Volume exceeds capacity, queue is theoretically infinite.
 Queue shown is maximum after two cycles.
 # 95th percentile volume exceeds capacity, queue may be longer.
 Queue shown is maximum after two cycles.
 m Volume for 95th percentile queue is metered by upstream signal.

Splits and Phases: 6: Warden Avenue & E-W2

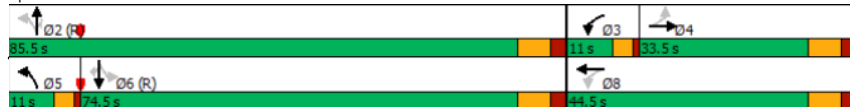

HCM Signalized Intersection Capacity Analysis
6: Warden Avenue & E-W2

BG 2041 AM
Baseline

	EBL	EBT	EBR	WBL	WBT	WBR	NBL	NBT	NBR	SBL	SBT	SBR
Lane Configurations	↔	↔	↔	↔	↔	↔	↔	↔	↔	↔	↔	↔
Traffic Volume (vph)	10	97	175	84	42	8	58	556	50	2	1809	10
Future Volume (vph)	10	97	175	84	42	8	58	556	50	2	1809	10
Ideal Flow (vphpl)	1900	1900	1900	1900	1900	1900	1900	1900	1900	1900	1900	1900
Total Lost time (s)	7.5	7.5		4.0	7.5		4.0	7.5	7.5	7.5	7.5	7.5
Lane Util. Factor	1.00	1.00		1.00	1.00		1.00	0.95	1.00	1.00	0.95	1.00
Fr't	1.00	0.90		1.00	0.98		1.00	1.00	0.85	1.00	1.00	0.85
Fit Protected	0.95	1.00		0.95	1.00		0.95	1.00	1.00	0.95	1.00	1.00
Satd. Flow (prot)	1789	1701		1789	1837		1789	3579	1601	1789	3579	1601
Fit Permitted	0.72	1.00		0.19	1.00		0.05	1.00	1.00	0.42	1.00	1.00
Satd. Flow (perm)	1358	1701		357	1837		99	3579	1601	798	3579	1601
Peak-hour factor, PHF	0.92	0.92	0.92	0.92	0.92	0.92	0.92	0.92	0.92	0.92	0.92	0.92
Adj. Flow (vph)	11	105	190	91	46	9	63	604	54	2	1966	11
RTOR Reduction (vph)	0	52	0	0	6	0	0	0	20	0	0	5
Lane Group Flow (vph)	11	243	0	91	49	0	63	604	34	2	1966	6
Turn Type	Perm	NA		pm+pt	NA		pm+pt	NA	Perm	Perm	NA	Perm
Protected Phases		4		3	8		5	2			6	
Permitted Phases	4			8			2		2	6		6
Actuated Green, G (s)	22.2	22.2		33.2	33.2		81.8	81.8	81.8	72.2	72.2	72.2
Effective Green, g (s)	22.2	22.2		33.2	33.2		81.8	81.8	81.8	72.2	72.2	72.2
Actuated g/C Ratio	0.17	0.17		0.26	0.26		0.63	0.63	0.63	0.56	0.56	0.56
Clearance Time (s)	7.5	7.5		4.0	7.5		4.0	7.5	7.5	7.5	7.5	7.5
Vehicle Extension (s)	3.0	3.0		3.0	3.0		3.0	3.0	3.0	3.0	3.0	3.0
Lane Grp Cap (vph)	231	290		168	469		135	2252	1007	443	1987	889
v/s Ratio Prot		c0.14		c0.03	0.03		c0.02	0.17			c0.55	
v/s Ratio Perm	0.01			0.11			0.27		0.02	0.00		0.00
v/c Ratio	0.05	0.84		0.54	0.10		0.47	0.27	0.03	0.00	0.99	0.01
Uniform Delay, d1	45.1	52.2		39.3	37.0		30.0	10.7	9.1	12.9	28.5	12.9
Progression Factor	1.00	1.00		1.00	1.00		2.92	0.38	1.06	1.27	0.91	1.00
Incremental Delay, d2	0.1	18.5		3.5	0.1		2.5	0.3	0.1	0.0	12.4	0.0
Delay (s)	45.1	70.7		42.8	37.1		90.2	4.4	9.7	16.4	38.4	12.9
Level of Service	D	E		D	D		F	A	A	B	D	B
Approach Delay (s)		69.8			40.7			12.3			38.2	
Approach LOS		E			D			B			D	

Intersection Summary

HCM 2000 Control Delay: 35.5, HCM 2000 Level of Service: D
 HCM 2000 Volume to Capacity ratio: 0.90
 Actuated Cycle Length (s): 130.0, Sum of lost time (s): 23.0
 Intersection Capacity Utilization: 87.5%, ICU Level of Service: E
 Analysis Period (min): 15
 c Critical Lane Group

Timings
7: Warden Avenue & N-S2

BG 2041 AM
Baseline

	EBL	EBT	WBL	WBT	NBL	NBT	NBR	SBL	SBT	SBR
Lane Configurations	↔	↔	↔	↔	↔	↕	↕	↔	↕	↕
Traffic Volume (vph)	19	17	51	43	39	664	13	4	2059	5
Future Volume (vph)	19	17	51	43	39	664	13	4	2059	5
Lane Group Flow (vph)	21	214	55	62	42	722	14	4	2238	5
Turn Type	Perm	NA	Perm	NA	Perm	NA	Perm	Perm	NA	Perm
Protected Phases		4		8		2		2	6	6
Permitted Phases	4		8		2		2	6		6
Detector Phase	4	4	8	8	2	2	2	6	6	6
Switch Phase										
Minimum Initial (s)	5.0	5.0	5.0	5.0	5.0	5.0	5.0	5.0	5.0	5.0
Minimum Split (s)	30.5	30.5	30.5	30.5	24.5	24.5	24.5	24.5	24.5	24.5
Total Split (s)	34.8	34.8	34.8	34.8	95.2	95.2	95.2	95.2	95.2	95.2
Total Split (%)	26.8%	26.8%	26.8%	26.8%	73.2%	73.2%	73.2%	73.2%	73.2%	73.2%
Yellow Time (s)	3.5	3.5	3.5	3.5	3.5	3.5	3.5	3.5	3.5	3.5
All-Red Time (s)	1.0	1.0	1.0	1.0	1.0	1.0	1.0	1.0	1.0	1.0
Lost Time Adjust (s)	0.0	0.0	0.0	0.0	0.0	0.0	0.0	0.0	0.0	0.0
Total Lost Time (s)	4.5	4.5	4.5	4.5	4.5	4.5	4.5	4.5	4.5	4.5
Lead/Lag										
Lead-Lag Optimize?										
Recall Mode	None	None	None	None	C-Max	C-Max	C-Max	C-Max	C-Max	C-Max
v/c Ratio	0.09	0.77	0.54	0.20	0.74	0.26	0.01	0.01	0.82	0.00
Control Delay	44.0	65.9	68.1	37.5	88.1	2.6	0.6	2.2	9.1	0.0
Queue Delay	0.0	0.0	0.0	0.0	0.0	0.0	0.0	0.0	0.5	0.0
Total Delay	44.0	65.9	68.1	37.5	88.1	2.6	0.6	2.2	9.6	0.0
Queue Length 50th (m)	4.6	49.7	13.1	11.1	6.3	11.5	0.1	0.1	56.2	0.0
Queue Length 95th (m)	11.5	72.2	26.0	22.3	m#32.5	14.2	m0.2	m0.1	m75.8	m0.0
Internal Link Dist (m)		78.5		142.8		263.5			414.0	
Turn Bay Length (m)	30.0		30.0		30.0		15.0		30.0	
Base Capacity (vph)	314	389	144	432	57	2743	1230	524	2743	1230
Starvation Cap Reductn	0	0	0	0	0	0	0	0	0	0
Spillback Cap Reductn	0	0	0	0	0	0	0	0	161	0
Storage Cap Reductn	0	0	0	0	0	0	0	0	0	0
Reduced v/c Ratio	0.07	0.55	0.38	0.14	0.74	0.26	0.01	0.01	0.87	0.00

Intersection Summary

Cycle Length: 130
 Actuated Cycle Length: 130
 Offset: 0 (0%), Referenced to phase 2:NBTL and 6:SBTL, Start of Green
 Natural Cycle: 90
 Control Type: Actuated-Coordinated
 # 95th percentile volume exceeds capacity, queue may be longer.
 Queue shown is maximum after two cycles.
 m Volume for 95th percentile queue is metered by upstream signal.

Splits and Phases: 7: Warden Avenue & N-S2

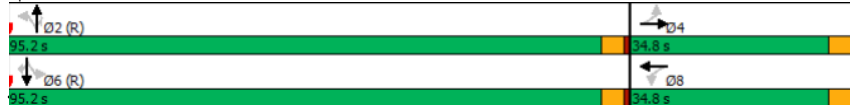

052314_bg2041_Revised.syn
 R.J. Burnside & Associates

Synchro 11 Report
 03/23/2023 - Page 13

HCM Signalized Intersection Capacity Analysis
 7: Warden Avenue & N-S2

BG 2041 AM
 Baseline

	EBL	EBT	EBR	WBL	WBT	WBR	NBL	NBT	NBR	SBL	SBT	SBR
Lane Configurations	↔	↔	↔	↔	↔	↔	↔	↕	↕	↔	↕	↕
Traffic Volume (vph)	19	17	180	51	43	14	39	664	13	4	2059	5
Future Volume (vph)	19	17	180	51	43	14	39	664	13	4	2059	5
Ideal Flow (vphpl)	1900	1900	1900	1900	1900	1900	1900	1900	1900	1900	1900	1900
Total Lost time (s)	4.5	4.5		4.5	4.5		4.5	4.5	4.5	4.5	4.5	4.5
Lane Util. Factor	1.00	1.00		1.00	1.00		1.00	0.95	1.00	1.00	0.95	1.00
Frt	1.00	0.86		1.00	0.96		1.00	1.00	0.85	1.00	1.00	0.85
Fit Protected	0.95	1.00		0.95	1.00		0.95	1.00	1.00	0.95	1.00	1.00
Satd. Flow (prot)	1789	1625		1789	1815		1789	3579	1601	1789	3579	1601
Fit Permitted	0.72	1.00		0.33	1.00		0.04	1.00	1.00	0.36	1.00	1.00
Satd. Flow (perm)	1350	1625		618	1815		76	3579	1601	685	3579	1601
Peak-hour factor, PHF	0.92	0.92	0.92	0.92	0.92	0.92	0.92	0.92	0.92	0.92	0.92	0.92
Adj. Flow (vph)	21	18	196	55	47	15	42	722	14	4	2238	5
RTOR Reduction (vph)	0	12	0	0	10	0	0	0	3	0	0	1
Lane Group Flow (vph)	21	202	0	55	52	0	42	722	11	4	2238	4
Turn Type	Perm	NA		Perm	NA		Perm	NA	Perm	Perm	NA	Perm
Protected Phases		4			8			2		2	6	6
Permitted Phases	4			8			2		2	6		6
Actuated Green, G (s)	21.4	21.4		21.4	21.4		99.6	99.6	99.6	99.6	99.6	99.6
Effective Green, g (s)	21.4	21.4		21.4	21.4		99.6	99.6	99.6	99.6	99.6	99.6
Actuated g/C Ratio	0.16	0.16		0.16	0.16		0.77	0.77	0.77	0.77	0.77	0.77
Clearance Time (s)	4.5	4.5		4.5	4.5		4.5	4.5	4.5	4.5	4.5	4.5
Vehicle Extension (s)	3.0	3.0		3.0	3.0		3.0	3.0	3.0	3.0	3.0	3.0
Lane Grp Cap (vph)	222	267		101	298		58	2742	1226	524	2742	1226
v/s Ratio Prot		c0.12			0.03			0.20			c0.63	
v/s Ratio Perm	0.02			0.09			0.56		0.01	0.01		0.00
v/c Ratio	0.09	0.76		0.54	0.17		0.72	0.26	0.01	0.01	0.82	0.00
Uniform Delay, d1	46.1	51.8		49.8	46.7		8.0	4.5	3.6	3.6	9.5	3.6
Progression Factor	1.00	1.00		1.00	1.00		1.89	0.48	0.26	0.47	0.73	0.03
Incremental Delay, d2	0.2	11.6		5.9	0.3		54.3	0.2	0.0	0.0	1.0	0.0
Delay (s)	46.3	63.4		55.7	47.0		69.4	2.4	0.9	1.7	7.9	0.1
Level of Service	D	E		E	D		E	A	A	A	A	A
Approach Delay (s)		61.9			51.1			5.9			7.9	
Approach LOS		E			D			A			A	

Intersection Summary

HCM 2000 Control Delay: 12.7, HCM 2000 Level of Service: B
 HCM 2000 Volume to Capacity ratio: 0.81
 Actuated Cycle Length (s): 130.0, Sum of lost time (s): 9.0
 Intersection Capacity Utilization: 84.3%, ICU Level of Service: E
 Analysis Period (min): 15
 c Critical Lane Group

052314_bg2041_Revised.syn
 R.J. Burnside & Associates

Synchro 11 Report
 03/23/2023 - Page 14

Timings
8: Warden Avenue & E-W3

BG 2041 AM
Baseline

	EBL	EBT	WBL	WBT	NBL	NBT	NBR	SBL	SBT	SBR
Lane Configurations	↔	↔	↔	↔	↔	↔	↔	↔	↔	↔
Traffic Volume (vph)	52	107	122	168	25	631	45	95	2110	85
Future Volume (vph)	52	107	122	168	25	631	45	95	2110	85
Lane Group Flow (vph)	57	213	133	219	27	686	49	103	2293	92
Turn Type	pm+pt	NA	Perm	NA	Perm	NA	Perm	pm+pt	NA	Perm
Protected Phases	7	4	8	8	2	2	2	1	6	6
Permitted Phases	4		8		2		2	6		6
Detector Phase	7	4	8	8	2	2	2	1	6	6
Switch Phase										
Minimum Initial (s)	5.0	10.0	10.0	10.0	30.0	30.0	30.0	5.0	30.0	30.0
Minimum Split (s)	9.5	33.5	33.5	33.5	37.5	37.5	37.5	9.5	37.5	37.5
Total Split (s)	9.5	43.0	33.5	33.5	77.2	77.2	77.2	9.8	87.0	87.0
Total Split (%)	7.3%	33.1%	25.8%	25.8%	59.4%	59.4%	59.4%	7.5%	66.9%	66.9%
Yellow Time (s)	3.5	5.0	5.0	5.0	5.0	5.0	5.0	3.5	5.0	5.0
All-Red Time (s)	1.0	2.5	2.5	2.5	2.5	2.5	2.5	1.0	2.5	2.5
Lost Time Adjust (s)	0.0	0.0	0.0	0.0	0.0	0.0	0.0	0.0	0.0	0.0
Total Lost Time (s)	4.5	7.5	7.5	7.5	7.5	7.5	7.5	4.5	7.5	7.5
Lead/Lag	Lead		Lag	Lag	Lag	Lag	Lag	Lead		
Lead-Lag Optimize?	Yes		Yes	Yes	Yes	Yes	Yes	Yes		
Recall Mode	None	None	None	None	C-Max	C-Max	C-Max	None	C-Max	C-Max
v/c Ratio	0.31	0.56	0.73	0.76	0.47	0.33	0.05	0.20	0.95	0.08
Control Delay	40.6	49.0	74.8	67.2	82.6	43.4	14.8	10.4	28.9	5.4
Queue Delay	0.0	0.0	0.0	0.0	0.0	0.0	0.0	0.0	1.0	0.0
Total Delay	40.6	49.0	74.8	67.2	82.6	43.4	14.8	10.4	29.9	5.4
Queue Length 50th (m)	11.3	46.8	32.8	52.6	7.3	97.4	3.3	11.1	227.8	4.0
Queue Length 95th (m)	21.2	67.5	52.9	76.0	m#17.0	117.7	12.0	m13.3	#374.5	m5.1
Internal Link Dist (m)		9.5		157.9		372.3			263.5	
Turn Bay Length (m)	30.0		30.0		21.0		30.0	27.0		30.0
Base Capacity (vph)	185	483	235	372	58	2090	981	503	2404	1100
Starvation Cap Reductn	0	0	0	0	0	0	0	0	31	0
Spillback Cap Reductn	0	0	0	0	0	0	0	0	0	0
Storage Cap Reductn	0	0	0	0	0	0	0	0	0	0
Reduced v/c Ratio	0.31	0.44	0.57	0.59	0.47	0.33	0.05	0.20	0.97	0.08

Intersection Summary

Cycle Length: 130
 Actuated Cycle Length: 130
 Offset: 0 (0%), Referenced to phase 2:NBTL and 6:SBTL, Start of Green
 Natural Cycle: 140
 Control Type: Actuated-Coordinated
 # 95th percentile volume exceeds capacity, queue may be longer.
 Queue shown is maximum after two cycles.
 m Volume for 95th percentile queue is metered by upstream signal.

Splits and Phases: 8: Warden Avenue & E-W3



052314_bg2041_Revised.syn
 R.J. Burnside & Associates

Synchro 11 Report
 03/23/2023 - Page 15

HCM Signalized Intersection Capacity Analysis
8: Warden Avenue & E-W3

BG 2041 AM
Baseline

	EBL	EBT	EBR	WBL	WBT	WBR	NBL	NBT	NBR	SBL	SBT	SBR
Lane Configurations	↔	↔	↔	↔	↔	↔	↔	↔	↔	↔	↔	↔
Traffic Volume (vph)	52	107	89	122	168	33	25	631	45	95	2110	85
Future Volume (vph)	52	107	89	122	168	33	25	631	45	95	2110	85
Ideal Flow (vphpl)	1900	1900	1900	1900	1900	1900	1900	1900	1900	1900	1900	1900
Total Lost time (s)	4.5	7.5		7.5	7.5		7.5	7.5	7.5	4.5	7.5	7.5
Lane Util. Factor	1.00	1.00		1.00	1.00		1.00	0.95	1.00	1.00	0.95	1.00
Fr't	1.00	0.93		1.00	0.98		1.00	1.00	0.85	1.00	1.00	0.85
Fit Protected	0.95	1.00		0.95	1.00		0.95	1.00	1.00	0.95	1.00	1.00
Satd. Flow (prot)	1789	1755		1789	1837		1789	3579	1601	1789	3579	1601
Fit Permitted	0.31	1.00		0.62	1.00		0.05	1.00	1.00	0.34	1.00	1.00
Satd. Flow (perm)	589	1755		1177	1837		100	3579	1601	636	3579	1601
Peak-hour factor, PHF	0.92	0.92	0.92	0.92	0.92	0.92	0.92	0.92	0.92	0.92	0.92	0.92
Adj. Flow (vph)	57	116	97	133	183	36	27	686	49	103	2293	92
RTOR Reduction (vph)	0	5	0	0	6	0	0	21	0	0	25	0
Lane Group Flow (vph)	57	208	0	133	213	0	27	686	28	103	2293	67
Turn Type	pm+pt	NA		Perm	NA		Perm	NA	Perm	pm+pt	NA	Perm
Protected Phases	7	4		8	8		2	2	2	1	6	6
Permitted Phases	4			8			2		2	6		6
Actuated Green, G (s)	28.6	28.6		20.1	20.1		75.0	75.0	75.0	86.4	86.4	86.4
Effective Green, g (s)	28.6	28.6		20.1	20.1		75.0	75.0	75.0	86.4	86.4	86.4
Actuated g/C Ratio	0.22	0.22		0.15	0.15		0.58	0.58	0.58	0.66	0.66	0.66
Clearance Time (s)	4.5	7.5		7.5	7.5		7.5	7.5	7.5	4.5	7.5	7.5
Vehicle Extension (s)	3.0	3.0		3.0	3.0		3.0	3.0	3.0	3.0	3.0	3.0
Lane Grp Cap (vph)	166	386		181	284		57	2064	923	483	2378	1064
v/s Ratio Prot	0.01	c0.12			c0.12			0.19		0.01	c0.64	
v/s Ratio Perm	0.06			0.11			0.27		0.02	0.13		0.04
v/c Ratio	0.34	0.54		0.73	0.75		0.47	0.33	0.03	0.21	0.96	0.06
Uniform Delay, d1	41.5	44.9		52.4	52.6		16.0	14.4	11.8	8.3	20.4	7.6
Progression Factor	1.00	1.00		1.00	1.00		2.52	2.86	1.00	1.27	1.04	1.81
Incremental Delay, d2	1.2	1.5		14.3	10.6		23.5	0.4	0.1	0.1	8.1	0.1
Delay (s)	42.7	46.3		66.7	63.2		63.9	41.5	11.9	10.6	29.2	13.9
Level of Service	D	D		E	E		E	D	B	B	C	B
Approach Delay (s)		45.6			64.5			40.4			27.8	
Approach LOS		D			E			D			C	

Intersection Summary

HCM 2000 Control Delay: 34.9, HCM 2000 Level of Service: C
 HCM 2000 Volume to Capacity ratio: 0.96
 Actuated Cycle Length (s): 130.0, Sum of lost time (s): 24.0
 Intersection Capacity Utilization: 117.1%, ICU Level of Service: H
 Analysis Period (min): 15
 c Critical Lane Group

052314_bg2041_Revised.syn
 R.J. Burnside & Associates

Synchro 11 Report
 03/23/2023 - Page 16

Timings
9: Kennedy Road & E-W1

BG 2041 AM
Baseline

	EBL	EBT	WBT	NBL	NBT	SBT	SBR
Lane Configurations	↔	↔	↔	↔	↔	↔	↔
Traffic Volume (vph)	11	109	129	67	522	1110	3
Future Volume (vph)	11	109	129	67	522	1110	3
Lane Group Flow (vph)	12	251	140	73	567	1207	3
Turn Type	Perm	NA	NA	Perm	NA	NA	Perm
Protected Phases		4	8		2	6	
Permitted Phases	4			2			6
Detector Phase	4	4	8	2	2	6	6
Switch Phase							
Minimum Initial (s)	10.0	10.0	10.0	30.0	30.0	30.0	30.0
Minimum Split (s)	33.5	33.5	33.5	40.0	40.0	40.0	40.0
Total Split (s)	36.0	36.0	36.0	94.0	94.0	94.0	94.0
Total Split (%)	27.7%	27.7%	27.7%	72.3%	72.3%	72.3%	72.3%
Yellow Time (s)	5.0	5.0	5.0	5.0	5.0	5.0	5.0
All-Red Time (s)	2.5	2.5	2.5	2.5	2.5	2.5	2.5
Lost Time Adjust (s)	0.0	0.0	0.0	0.0	0.0	0.0	0.0
Total Lost Time (s)	7.5	7.5	7.5	7.5	7.5	7.5	7.5
Lead/Lag							
Lead-Lag Optimize?							
Recall Mode	None	None	None	C-Max	C-Max	C-Max	C-Max
v/c Ratio	0.10	0.63	0.42	0.23	0.20	0.43	0.00
Control Delay	54.5	41.4	58.9	18.3	14.4	2.1	0.0
Queue Delay	0.0	0.0	0.0	0.0	0.0	0.0	0.0
Total Delay	54.5	41.4	58.9	18.3	14.4	2.1	0.0
Queue Length 50th (m)	2.9	20.0	18.2	12.1	48.6	14.5	0.0
Queue Length 95th (m)	8.9	33.0	27.8	24.6	63.2	19.1	0.0
Internal Link Dist (m)		139.9	134.7		466.1	491.8	
Turn Bay Length (m)	30.0			29.0		30.0	
Base Capacity (vph)	273	799	784	321	2831	2831	1274
Starvation Cap Reductn	0	0	0	0	0	0	0
Spillback Cap Reductn	0	0	0	0	0	0	0
Storage Cap Reductn	0	0	0	0	0	0	0
Reduced v/c Ratio	0.04	0.31	0.18	0.23	0.20	0.43	0.00

Intersection Summary

Cycle Length: 130
 Actuated Cycle Length: 130
 Offset: 0 (0%), Referenced to phase 2:NBTL and 6:SBTL, Start of Green
 Natural Cycle: 75
 Control Type: Actuated-Coordinated
 m Volume for 95th percentile queue is metered by upstream signal.

Splits and Phases: 9: Kennedy Road & E-W1

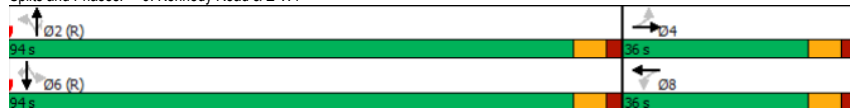

HCM Signalized Intersection Capacity Analysis
9: Kennedy Road & E-W1

BG 2041 AM
Baseline

	EBL	EBT	EBR	WBL	WBT	WBR	NBL	NBT	NBR	SBL	SBT	SBR
Lane Configurations	↔	↔	↔	↔	↔	↔	↔	↔	↔	↔	↔	↔
Traffic Volume (vph)	11	109	122	0	129	0	67	522	0	0	1110	3
Future Volume (vph)	11	109	122	0	129	0	67	522	0	0	1110	3
Ideal Flow (vphpl)	1900	1900	1900	1900	1900	1900	1900	1900	1900	1900	1900	1900
Total Lost time (s)	7.5	7.5		7.5	7.5	7.5	7.5	7.5		7.5	7.5	
Lane Util. Factor	1.00	0.95		0.95	1.00	0.95	1.00	0.95		0.95	1.00	
Fr't	1.00	0.92		1.00	1.00	1.00	1.00	1.00		1.00	0.85	
Fit Protected	0.95	1.00		1.00	0.95	1.00	0.95	1.00		1.00	1.00	
Satd. Flow (prot)	1789	3294		3579	1789	3579	1789	3579		3579	1601	
Fit Permitted	0.66	1.00		1.00	0.22	1.00				1.00	1.00	
Satd. Flow (perm)	1249	3294		3579	408	3579				3579	1601	
Peak-hour factor, PHF	0.92	0.92	0.92	0.92	0.92	0.92	0.92	0.92	0.92	0.92	0.92	0.92
Adj. Flow (vph)	12	118	133	0	140	0	73	567	0	0	1207	3
RTOR Reduction (vph)	0	89	0	0	0	0	0	0	0	0	0	1
Lane Group Flow (vph)	12	162	0	0	140	0	73	567	0	0	1207	2
Turn Type	Perm	NA		Perm	NA		Perm	NA		Perm	Perm	NA
Protected Phases		4			8			2			6	
Permitted Phases	4			8			2		2	6		6
Actuated Green, G (s)	12.2	12.2			12.2		102.8	102.8			102.8	102.8
Effective Green, g (s)	12.2	12.2			12.2		102.8	102.8			102.8	102.8
Actuated g/C Ratio	0.09	0.09			0.09		0.79	0.79			0.79	0.79
Clearance Time (s)	7.5	7.5			7.5		7.5	7.5			7.5	7.5
Vehicle Extension (s)	3.0	3.0			3.0		3.0	3.0			3.0	3.0
Lane Grp Cap (vph)	117	309			335		322	2830			2830	1266
v/s Ratio Prot		c0.05			0.04			0.16			c0.34	
v/s Ratio Perm	0.01						0.18					0.00
v/c Ratio	0.10	0.52			0.42		0.23	0.20			0.43	0.00
Uniform Delay, d1	53.9	56.1			55.6		3.5	3.4			4.3	2.8
Progression Factor	1.00	1.00			1.00		4.02	4.01			0.42	1.00
Incremental Delay, d2	0.4	1.6			0.8		1.6	0.2			0.2	0.0
Delay (s)	54.3	57.7			56.4		15.5	13.7			2.0	2.9
Level of Service	D	E			E		B	B			A	A
Approach Delay (s)		57.6			56.4			13.9			2.0	
Approach LOS		E			E			B			A	

Intersection Summary

HCM 2000 Control Delay: 15.3, HCM 2000 Level of Service: B
 HCM 2000 Volume to Capacity ratio: 0.44
 Actuated Cycle Length (s): 130.0, Sum of lost time (s): 15.0
 Intersection Capacity Utilization: 77.3%, ICU Level of Service: D
 Analysis Period (min): 15
 c Critical Lane Group

HCM Unsignalized Intersection Capacity Analysis
10: Kennedy Road & L-3

BG 2041 AM
Baseline

Movement	EBL	EBT	EBR	WBL	WBT	WBR	NBL	NBT	NBR	SBL	SBT	SBR	
Lane Configurations	↔	↔	↔	↔	↔	↔	↔	↔	↔	↔	↔	↔	
Traffic Volume (veh/h)	10	25	39	0	26	0	10	579	0	0	1229	3	
Future Volume (Veh/h)	10	25	39	0	26	0	10	579	0	0	1229	3	
Sign Control	Stop			Stop			Free			Free			
Grade	0%			0%			0%			0%			
Peak Hour Factor	0.92	0.92	0.92	0.92	0.92	0.92	0.92	0.92	0.92	0.92	0.92	0.92	
Hourly flow rate (vph)	11	27	42	0	28	0	11	629	0	0	1336	3	
Pedestrians													
Lane Width (m)													
Walking Speed (m/s)													
Percent Blockage													
Right turn flare (veh)													
Median type	None						None						
Median storage (veh)													
Upstream signal (m)													
pX, platoon unblocked													
vC, conflicting volume	1686	1987	668	1374	1990	314	1339						629
vC1, stage 1 conf vol													
vC2, stage 2 conf vol													
vCu, unblocked vol	1686	1987	668	1374	1990	314	1339						629
tC, single (s)	7.5	6.5	6.9	7.5	6.5	6.9	4.1						4.1
tC, 2 stage (s)													
tF (s)	3.5	4.0	3.3	3.5	4.0	3.3	2.2						2.2
p0 queue free %	71	54	90	100	52	100	98						100
cM capacity (veh/h)	38	59	401	59	59	681	511						949
Direction, Lane #	EB 1	EB 2	WB 1	WB 2	NB 1	NB 2	NB 3	NB 4	SB 1	SB 2	SB 3	SB 4	
Volume Total	11	69	0	28	11	314	314	0	0	668	668	3	
Volume Left	11	0	0	0	11	0	0	0	0	0	0	0	
Volume Right	0	42	0	0	0	0	0	0	0	0	0	3	
cSH	38	123	1700	59	511	1700	1700	1700	1700	1700	1700	1700	
Volume to Capacity	0.29	0.56	0.00	0.48	0.02	0.18	0.18	0.00	0.00	0.39	0.39	0.00	
Queue Length 95th (m)	7.3	20.8	0.0	14.0	0.5	0.0	0.0	0.0	0.0	0.0	0.0	0.0	
Control Delay (s)	136.2	66.7	0.0	112.8	12.2	0.0	0.0	0.0	0.0	0.0	0.0	0.0	
Lane LOS	F	F	A	F	B								
Approach Delay (s)	76.2	112.8		0.2		0.0							
Approach LOS	F	F											
Intersection Summary													
Average Delay	4.5												
Intersection Capacity Utilization	47.9%			ICU Level of Service			A						
Analysis Period (min)	15												

Timings
11: Kennedy Road & E-W3

BG 2041 AM
Baseline

Lane Group	EBL	EBT	WBT	NBL	NBT	SBT	SBR
Lane Configurations	↔	↔	↔	↔	↔	↔	↔
Traffic Volume (vph)	7	58	45	59	582	1266	2
Future Volume (vph)	7	58	45	59	582	1266	2
Lane Group Flow (vph)	8	212	49	64	633	1376	2
Turn Type	Perm	NA	NA	Perm	NA	NA	Perm
Protected Phases	4		8	2		6	
Permitted Phases	4			2			6
Detector Phase	4	4	8	2	2	6	6
Switch Phase							
Minimum Initial (s)	10.0	10.0	10.0	30.0	30.0	30.0	30.0
Minimum Split (s)	27.5	27.5	27.5	37.5	37.5	37.5	37.5
Total Split (s)	39.0	39.0	39.0	91.0	91.0	91.0	91.0
Total Split (%)	30.0%	30.0%	30.0%	70.0%	70.0%	70.0%	70.0%
Yellow Time (s)	5.0	5.0	5.0	5.0	5.0	5.0	5.0
All-Red Time (s)	2.5	2.5	2.5	2.5	2.5	2.5	2.5
Lost Time Adjust (s)	0.0	0.0	0.0	0.0	0.0	0.0	0.0
Total Lost Time (s)	7.5	7.5	7.5	7.5	7.5	7.5	7.5
Lead/Lag							
Lead-Lag Optimize?							
Recall Mode	None	None	None	C-Max	C-Max	C-Max	C-Max
v/c Ratio	0.04	0.76	0.20	0.27	0.24	0.51	0.00
Control Delay	45.7	54.8	49.4	8.0	3.5	15.5	0.0
Queue Delay	0.0	0.0	0.0	0.0	0.0	0.0	0.0
Total Delay	45.7	54.8	49.4	8.0	3.5	15.5	0.0
Queue Length 50th (m)	1.8	37.7	11.3	2.5	12.4	154.3	0.0
Queue Length 95th (m)	6.2	60.7	21.8	6.9	20.7	180.6	m0.0
Internal Link Dist (m)	142.7		136.9	395.2		561.7	
Turn Bay Length (m)	30.0			29.0		30.0	
Base Capacity (vph)	330	455	456	237	2686	2686	1211
Starvation Cap Reductn	0	0	0	0	0	0	0
Spillback Cap Reductn	0	0	0	0	0	0	0
Storage Cap Reductn	0	0	0	0	0	0	0
Reduced v/c Ratio	0.02	0.47	0.11	0.27	0.24	0.51	0.00
Intersection Summary							
Cycle Length: 130							
Actuated Cycle Length: 130							
Offset: 0 (0%), Referenced to phase 2:NBTL and 6:SBTL, Start of Green							
Natural Cycle: 65							
Control Type: Actuated-Coordinated							
m Volume for 95th percentile queue is metered by upstream signal.							

Splits and Phases: 11: Kennedy Road & E-W3

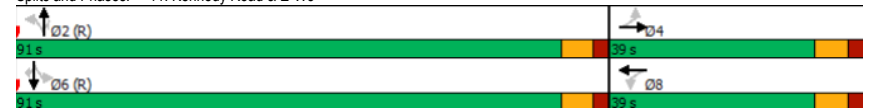

HCM Signalized Intersection Capacity Analysis

BG 2041 AM

11: Kennedy Road & E-W3

Baseline



Movement	EBL	EBT	EBR	WBL	WBT	WBR	NBL	NBT	NBR	SBL	SBT	SBR
Lane Configurations	↘	↘		↘	↘		↘	↘	↘	↘	↘	↘
Traffic Volume (vph)	7	58	137	0	45	0	59	582	0	0	1266	2
Future Volume (vph)	7	58	137	0	45	0	59	582	0	0	1266	2
Ideal Flow (vphpl)	1900	1900	1900	1900	1900	1900	1900	1900	1900	1900	1900	1900
Total Lost time (s)	7.5	7.5			7.5		7.5	7.5			7.5	7.5
Lane Util. Factor	1.00	1.00			1.00		1.00	0.95			0.95	1.00
Frt	1.00	0.89			1.00		1.00	1.00			1.00	0.85
Fit Protected	0.95	1.00			1.00		0.95	1.00			1.00	1.00
Satd. Flow (prot)	1789	1685			1883		1789	3579			3579	1601
Fit Permitted	0.73	1.00			1.00		0.17	1.00			1.00	1.00
Satd. Flow (perm)	1366	1685			1883		316	3579			3579	1601
Peak-hour factor, PHF	0.92	0.92	0.92	0.92	0.92	0.92	0.92	0.92	0.92	0.92	0.92	0.92
Adj. Flow (vph)	8	63	149	0	49	0	64	633	0	0	1376	2
RTOR Reduction (vph)	0	54	0	0	0	0	0	0	0	0	0	0
Lane Group Flow (vph)	8	158	0	0	49	0	64	633	0	0	1376	2
Turn Type	Perm	NA		Perm	NA		Perm	NA	Perm	Perm	NA	Perm
Protected Phases		4			8			2		2	6	
Permitted Phases	4			8			2		2	6		6
Actuated Green, G (s)	17.4	17.4			17.4		97.6	97.6			97.6	97.6
Effective Green, g (s)	17.4	17.4			17.4		97.6	97.6			97.6	97.6
Actuated g/C Ratio	0.13	0.13			0.13		0.75	0.75			0.75	0.75
Clearance Time (s)	7.5	7.5			7.5		7.5	7.5			7.5	7.5
Vehicle Extension (s)	3.0	3.0			3.0		3.0	3.0			3.0	3.0
Lane Grp Cap (vph)	182	225			252		237	2687			2687	1201
v/s Ratio Prot		c0.09			0.03			0.18			c0.38	
v/s Ratio Perm	0.01						0.20					0.00
v/c Ratio	0.04	0.70			0.19		0.27	0.24			0.51	0.00
Uniform Delay, d1	49.1	53.8			50.1		5.1	4.9			6.6	4.0
Progression Factor	1.00	1.00			1.00		0.76	0.60			2.05	1.00
Incremental Delay, d2	0.1	9.6			0.4		2.7	0.2			0.7	0.0
Delay (s)	49.2	63.4			50.4		6.5	3.2			14.1	4.0
Level of Service	D	E			D		A	A			B	A
Approach Delay (s)		62.9			50.4			3.5			14.1	
Approach LOS		E			D			A			B	

Intersection Summary			
HCM 2000 Control Delay	16.3	HCM 2000 Level of Service	B
HCM 2000 Volume to Capacity ratio	0.54		
Actuated Cycle Length (s)	130.0	Sum of lost time (s)	15.0
Intersection Capacity Utilization	77.1%	ICU Level of Service	D
Analysis Period (min)	15		

c Critical Lane Group

Timings
1: Warden Avenue & Elgin Mills Road

BG 2041 PM

	EBL	EBT	EBR	WBL	WBT	WBR	NBL	NBT	NBR	SBL	SBT	SBR
Lane Configurations	↔	↔	↔	↔	↔	↔	↔	↔	↔	↔	↔	↔
Traffic Volume (vph)	50	1156	103	23	469	14	204	1087	155	15	194	22
Future Volume (vph)	50	1156	103	23	469	14	204	1087	155	15	194	22
Lane Group Flow (vph)	54	1257	112	25	510	15	222	1182	168	16	211	24
Turn Type	Perm	NA	Perm	Perm	NA	Perm	pm+pt	NA	Perm	Perm	NA	Perm
Protected Phases		4			8		5	2		6		6
Permitted Phases	4		4	8		8	2		2	6		6
Detector Phase	4	4	4	8	8	8	5	2	2	6	6	6
Switch Phase												
Minimum Initial (s)	10.0	10.0	10.0	10.0	10.0	10.0	7.0	30.0	30.0	30.0	30.0	30.0
Minimum Split (s)	41.5	41.5	41.5	41.5	41.5	41.5	11.0	47.0	47.0	47.0	47.0	47.0
Total Split (s)	67.0	67.0	67.0	67.0	67.0	67.0	14.0	63.0	63.0	49.0	49.0	49.0
Total Split (%)	51.5%	51.5%	51.5%	51.5%	51.5%	51.5%	10.8%	48.5%	48.5%	37.7%	37.7%	37.7%
Yellow Time (s)	4.5	4.5	4.5	4.5	4.5	4.5	3.0	5.0	5.0	5.0	5.0	5.0
All-Red Time (s)	2.5	2.5	2.5	2.5	2.5	2.5	1.0	2.0	2.0	2.0	2.0	2.0
Lost Time Adjust (s)	0.0	0.0	0.0	0.0	0.0	0.0	0.0	0.0	0.0	0.0	0.0	0.0
Total Lost Time (s)	7.0	7.0	7.0	7.0	7.0	7.0	4.0	7.0	7.0	7.0	7.0	7.0
Lead/Lag							Lead			Lag	Lag	Lag
Lead-Lag Optimize?							Yes			Yes	Yes	Yes
Recall Mode	None	None	None	None	None	None	None	C-Max	C-Max	C-Max	C-Max	C-Max
v/c Ratio	0.16	0.85	0.15	0.43	0.34	0.02	0.37	0.70	0.21	0.14	0.17	0.04
Control Delay	23.4	40.4	9.8	46.1	19.7	1.3	27.0	34.6	24.4	35.4	30.5	0.1
Queue Delay	0.0	0.0	0.0	0.0	0.0	0.0	0.0	0.0	0.0	0.0	0.0	0.0
Total Delay	23.4	40.4	9.8	46.1	19.7	1.3	27.0	34.6	24.4	35.4	30.5	0.1
Queue Length 50th (m)	8.4	149.1	6.7	5.4	56.3	0.3	36.6	113.2	23.8	2.9	20.4	0.0
Queue Length 95th (m)	16.6	167.1	17.0	m15.1	67.5	m1.5	54.1	128.0	39.7	9.3	30.2	0.0
Internal Link Dist (m)		25.6			1983.6			461.7			82.4	
Turn Bay Length (m)	30.0		40.0	52.0		14.0	48.0		36.0	15.0		47.0
Base Capacity (vph)	364	1620	789	64	1635	789	608	1693	790	114	1264	620
Starvation Cap Reductn	0	0	0	0	0	0	0	0	0	0	0	0
Spillback Cap Reductn	0	0	0	0	0	0	0	0	0	0	0	0
Storage Cap Reductn	0	0	0	0	0	0	0	0	0	0	0	0
Reduced v/c Ratio	0.15	0.78	0.14	0.39	0.31	0.02	0.37	0.70	0.21	0.14	0.17	0.04

Intersection Summary
 Cycle Length: 130
 Actuated Cycle Length: 130
 Offset: 0 (0%), Referenced to phase 2:NBTL and 6:SBTL, Start of Green
 Natural Cycle: 100
 Control Type: Actuated-Coordinated
 m Volume for 95th percentile queue is metered by upstream signal.

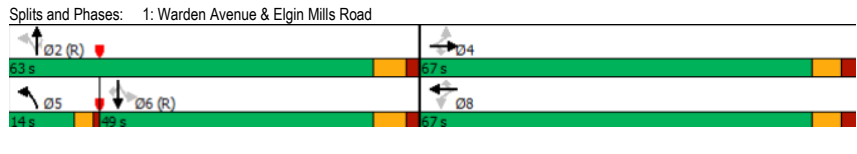

HCM Signalized Intersection Capacity Analysis
1: Warden Avenue & Elgin Mills Road

BG 2041 PM

	EBL	EBT	EBR	WBL	WBT	WBR	NBL	NBT	NBR	SBL	SBT	SBR
Lane Configurations	↔	↔	↔	↔	↔	↔	↔	↔	↔	↔	↔	↔
Traffic Volume (vph)	50	1156	103	23	469	14	204	1087	155	15	194	22
Future Volume (vph)	50	1156	103	23	469	14	204	1087	155	15	194	22
Ideal Flow (vphpl)	1900	1900	1900	1900	1900	1900	1900	1900	1900	1900	1900	1900
Total Lost time (s)	7.0	7.0	7.0	7.0	7.0	7.0	4.0	7.0	7.0	7.0	7.0	7.0
Lane Util. Factor	1.00	0.95	1.00	1.00	0.95	1.00	1.00	0.95	1.00	0.95	1.00	0.95
Fr't	1.00	1.00	0.85	1.00	1.00	0.85	1.00	1.00	0.85	1.00	1.00	0.85
Fit Protected	0.95	1.00	1.00	0.95	1.00	0.95	1.00	0.95	1.00	1.00	0.95	1.00
Satd. Flow (prot)	1825	3510	1633	1825	3544	1633	1825	3579	1633	1825	3579	1633
Fit Permitted	0.41	1.00	1.00	0.07	1.00	1.00	0.57	1.00	1.00	0.17	1.00	1.00
Satd. Flow (perm)	790	3510	1633	141	3544	1633	1095	3579	1633	323	3579	1633
Peak-hour factor, PHF	0.92	0.92	0.92	0.92	0.92	0.92	0.92	0.92	0.92	0.92	0.92	0.92
Adj. Flow (vph)	54	1257	112	25	510	15	222	1182	168	16	211	24
RTOR Reduction (vph)	0	0	39	0	0	9	0	0	18	0	0	16
Lane Group Flow (vph)	54	1257	73	25	510	6	222	1182	150	16	211	8
Heavy Vehicles (%)	0%	4%	0%	0%	3%	0%	0%	2%	0%	0%	2%	0%
Turn Type	Perm	NA	Perm	Perm	NA	Perm	pm+pt	NA	Perm	Perm	NA	Perm
Protected Phases		4			8		5	2		6		6
Permitted Phases	4		4	8		8	2		2	6		6
Actuated Green, G (s)	54.5	54.5	54.5	54.5	54.5	54.5	61.5	61.5	61.5	45.9	45.9	45.9
Effective Green, g (s)	54.5	54.5	54.5	54.5	54.5	54.5	61.5	61.5	61.5	45.9	45.9	45.9
Actuated g/C Ratio	0.42	0.42	0.42	0.42	0.42	0.42	0.47	0.47	0.47	0.35	0.35	0.35
Clearance Time (s)	7.0	7.0	7.0	7.0	7.0	7.0	4.0	7.0	7.0	7.0	7.0	7.0
Vehicle Extension (s)	3.0	3.0	3.0	3.0	3.0	3.0	3.0	3.0	3.0	3.0	3.0	3.0
Lane Grp Cap (vph)	331	1471	684	59	1485	684	583	1693	772	114	1263	576
v/s Ratio Prot		c0.36			0.14		0.15	c0.33			0.06	
v/s Ratio Perm	0.07		0.04	0.18		0.00	0.15		0.09	0.05		0.01
v/c Ratio	0.16	0.85	0.11	0.42	0.34	0.01	0.38	0.70	0.19	0.14	0.17	0.01
Uniform Delay, d1	23.5	34.2	23.0	26.7	25.6	22.0	20.6	26.9	19.9	28.6	28.9	27.3
Progression Factor	1.00	1.00	1.00	0.87	0.76	1.00	1.27	1.16	1.40	1.00	1.00	1.00
Incremental Delay, d2	0.2	5.1	0.1	4.7	0.1	0.0	0.3	1.9	0.4	2.6	0.3	0.0
Delay (s)	23.8	39.2	23.0	27.8	19.6	22.0	26.5	33.2	28.2	31.2	29.2	27.4
Level of Service	C	D	C	C	B	C	C	C	C	C	C	C
Approach Delay (s)		37.4			20.1			31.7			29.1	
Approach LOS		D			C			C			C	

Intersection Summary
 HCM 2000 Control Delay: 32.0
 HCM 2000 Level of Service: C
 HCM 2000 Volume to Capacity ratio: 0.80
 Actuated Cycle Length (s): 130.0
 Sum of lost time (s): 18.0
 Intersection Capacity Utilization: 114.1%
 ICU Level of Service: H
 Analysis Period (min): 15
 c Critical Lane Group

Timings
2: Warden Avenue & Major Mackenzie Drive East

BG 2041 PM

	EBL	EBT	EBR	WBL	WBT	WBR	NBL	NBT	NBR	SBL	SBT	SBR
Lane Configurations	↔	↔↔	↔	↔	↔↔	↔	↔	↔↔	↔	↔	↔↔	↔
Traffic Volume (vph)	200	1970	126	109	740	150	210	1800	330	35	650	21
Future Volume (vph)	200	1970	126	109	740	150	210	1800	330	35	650	21
Lane Group Flow (vph)	217	2141	137	118	804	163	228	1957	359	38	707	23
Turn Type	Perm	NA	Perm	pm+pt	NA	Perm	pm+pt	NA	Perm	Perm	NA	Perm
Protected Phases		2		1	6		3	8			4	
Permitted Phases	2		2	6		6	8		8	4		4
Detector Phase	2	2	2	1	6	6	3	8	8	4	4	4
Switch Phase												
Minimum Initial (s)	30.0	30.0	30.0	7.0	30.0	30.0	7.0	10.0	10.0	10.0	10.0	10.0
Minimum Split (s)	47.5	47.5	47.5	11.0	47.5	47.5	11.0	41.5	41.5	41.5	41.5	41.5
Total Split (s)	63.0	63.0	63.0	12.0	75.0	75.0	12.0	55.0	55.0	43.0	43.0	43.0
Total Split (%)	48.5%	48.5%	48.5%	9.2%	57.7%	57.7%	9.2%	42.3%	42.3%	33.1%	33.1%	33.1%
Yellow Time (s)	5.0	5.0	5.0	3.0	5.0	5.0	3.0	4.5	4.5	4.5	4.5	4.5
All-Red Time (s)	2.5	2.5	2.5	1.0	2.5	2.5	1.0	3.0	3.0	3.0	3.0	3.0
Lost Time Adjust (s)	0.0	0.0	0.0	0.0	0.0	0.0	0.0	0.0	0.0	0.0	0.0	0.0
Total Lost Time (s)	7.5	7.5	7.5	4.0	7.5	7.5	4.0	7.5	7.5	7.5	7.5	7.5
Lead/Lag	Lag	Lag	Lag	Lead			Lead			Lag	Lag	Lag
Lead-Lag Optimize?	Yes	Yes	Yes	Yes								
Recall Mode	C-Max	C-Max	C-Max	None	C-Max	C-Max	None	Max	Max	Max	Max	Max
v/c Ratio	0.78	1.40	0.19	0.71	0.44	0.20	1.05	1.50	0.54	0.67	0.73	0.04
Control Delay	52.8	216.3	7.4	60.4	24.2	15.0	106.1	261.0	22.9	94.3	47.9	0.1
Queue Delay	0.0	0.0	0.0	0.0	0.0	0.0	0.0	0.0	0.0	0.0	0.0	0.0
Total Delay	52.8	216.3	7.4	60.4	24.2	15.0	106.1	261.0	22.9	94.3	47.9	0.1
Queue Length 50th (m)	47.0	~386.2	4.7	25.1	64.0	14.2	~43.2	~365.4	44.1	8.7	86.6	0.0
Queue Length 95th (m)	#91.2	#427.4	16.9	m#46.2	83.4	m28.4	#93.5	#407.2	74.5	#28.3	108.6	0.0
Internal Link Dist (m)		76.9			1995.6			120.3			372.3	
Turn Bay Length (m)	109.0		33.0	80.0		35.0	72.0		83.0	28.0		57.0
Base Capacity (vph)	279	1527	736	167	1835	831	218	1304	659	57	974	512
Starvation Cap Reductn	0	0	0	0	0	0	0	0	0	0	0	0
Spillback Cap Reductn	0	0	0	0	0	0	0	0	0	0	0	0
Storage Cap Reductn	0	0	0	0	0	0	0	0	0	0	0	0
Reduced v/c Ratio	0.78	1.40	0.19	0.71	0.44	0.20	1.05	1.50	0.54	0.67	0.73	0.04

Intersection Summary
 Cycle Length: 130
 Actuated Cycle Length: 130
 Offset: 0 (0%), Referenced to phase 2:EBTL and 6:WBTL, Start of Green
 Natural Cycle: 145
 Control Type: Actuated-Coordinated
 ~ Volume exceeds capacity, queue is theoretically infinite.
 Queue shown is maximum after two cycles.
 # 95th percentile volume exceeds capacity, queue may be longer.
 Queue shown is maximum after two cycles.
 m Volume for 95th percentile queue is metered by upstream signal.

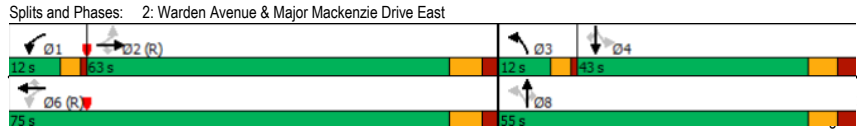

HCM Signalized Intersection Capacity Analysis
2: Warden Avenue & Major Mackenzie Drive East

BG 2041 PM

	EBL	EBT	EBR	WBL	WBT	WBR	NBL	NBT	NBR	SBL	SBT	SBR
Lane Configurations	↔	↔↔	↔	↔	↔↔	↔	↔	↔↔	↔	↔	↔↔	↔
Traffic Volume (vph)	200	1970	126	109	740	150	210	1800	330	35	650	21
Future Volume (vph)	200	1970	126	109	740	150	210	1800	330	35	650	21
Ideal Flow (vphpl)	1900	1900	1900	1900	1900	1900	1900	1900	1900	1900	1900	1900
Lane Width	3.5	3.5	3.5	3.5	3.5	3.5	3.5	3.5	3.5	3.5	3.5	3.5
Total Lost time (s)	7.5	7.5	7.5	4.0	7.5	7.5	4.0	7.5	7.5	7.5	7.5	7.5
Lane Util. Factor	1.00	0.95	1.00	1.00	0.95	1.00	1.00	0.95	1.00	1.00	0.95	1.00
Fit	1.00	1.00	0.85	1.00	1.00	0.85	1.00	1.00	0.85	1.00	1.00	0.85
Fit Protected	0.95	1.00	1.00	0.95	1.00	1.00	0.95	1.00	1.00	0.95	1.00	1.00
Satd. Flow (prot)	1785	3570	1581	1750	3535	1536	1767	3570	1566	1785	3570	1597
Fit Permitted	0.35	1.00	1.00	0.07	1.00	1.00	0.18	1.00	1.00	0.11	1.00	1.00
Satd. Flow (perm)	654	3570	1581	124	3535	1536	331	3570	1566	212	3570	1597
Peak-hour factor, PHF	0.92	0.92	0.92	0.92	0.92	0.92	0.92	0.92	0.92	0.92	0.92	0.92
Adj. Flow (vph)	217	2141	137	118	804	163	228	1957	359	38	707	23
RTOR Reduction (vph)	0	0	60	0	34	0	88	0	88	0	0	17
Lane Group Flow (vph)	217	2141	77	118	804	129	228	1957	271	38	707	23
Heavy Vehicles (%)	0%	0%	1%	2%	1%	4%	1%	0%	2%	0%	0%	6%
Turn Type	Perm	NA	Perm	pm+pt	NA	Perm	pm+pt	NA	Perm	Perm	NA	Perm
Protected Phases		2		1	6		3	8			4	
Permitted Phases	2		2	6		6	8		8	4		4
Actuated Green, G (s)	55.6	55.6	55.6	67.5	67.5	67.5	47.5	47.5	47.5	35.5	35.5	35.5
Effective Green, g (s)	55.6	55.6	55.6	67.5	67.5	67.5	47.5	47.5	47.5	35.5	35.5	35.5
Actuated g/C Ratio	0.43	0.43	0.43	0.52	0.52	0.52	0.37	0.37	0.37	0.27	0.27	0.27
Clearance Time (s)	7.5	7.5	7.5	4.0	7.5	7.5	4.0	7.5	7.5	7.5	7.5	7.5
Vehicle Extension (s)	3.0	3.0	3.0	3.0	3.0	3.0	3.0	3.0	3.0	3.0	3.0	3.0
Lane Grp Cap (vph)	279	1526	676	163	1835	797	209	1304	572	57	974	436
v/s Ratio Prot		c0.60		c0.04	0.23		0.07	c0.55			0.20	
v/s Ratio Perm	0.33		0.05	0.33		0.08	0.33		0.17	0.18		0.00
v/c Ratio	0.78	1.40	0.11	0.72	0.44	0.16	1.09	1.50	0.47	0.67	0.73	0.01
Uniform Delay, d1	31.9	37.2	22.4	28.8	19.4	16.4	37.9	41.2	31.7	42.0	42.8	34.5
Progression Factor	1.00	1.00	1.00	2.01	1.20	1.57	1.00	1.00	1.00	1.00	1.00	1.00
Incremental Delay, d2	19.0	185.4	0.3	12.2	0.6	0.4	88.6	229.4	2.8	47.9	4.7	0.1
Delay (s)	50.9	222.6	22.7	70.1	24.0	26.0	126.6	270.7	34.5	89.9	47.6	34.5
Level of Service	D	F	C	E	C	C	F	F	C	F	D	C
Approach Delay (s)		196.7			29.3		224.4				49.3	
Approach LOS		F			C		F				D	
Intersection Summary												
HCM 2000 Control Delay	164.1			HCM 2000 Level of Service						F		
HCM 2000 Volume to Capacity ratio	1.45											
Actuated Cycle Length (s)	130.0			Sum of lost time (s)						23.0		
Intersection Capacity Utilization	140.7%			ICU Level of Service						H		
Analysis Period (min)	15											
c Critical Lane Group												

Timings
3: Kennedy Road & Elgin Mills Road

BG 2041 PM

	EBL	EBT	EBR	WBL	WBT	WBR	NBL	NBT	NBR	SBL	SBT
Lane Configurations	↔	↔↔	↔	↔	↔↔	↔	↔	↔	↔	↔	↔↔
Traffic Volume (vph)	59	1123	131	21	380	7	115	470	56	15	391
Future Volume (vph)	59	1123	131	21	380	7	115	470	56	15	391
Lane Group Flow (vph)	77	1458	170	27	494	9	149	610	73	19	529
Turn Type	Perm	NA	Perm	Perm	NA	Perm	pm+pt	NA	Perm	Perm	NA
Protected Phases		4			8		5	2			6
Permitted Phases	4		4	8		8	2		2	6	
Detector Phase	4	4	4	8	8	8	5	2	2	6	6
Switch Phase											
Minimum Initial (s)	10.0	10.0	10.0	10.0	10.0	10.0	5.0	30.0	30.0	30.0	30.0
Minimum Split (s)	32.0	32.0	32.0	32.0	32.0	32.0	12.5	45.0	45.0	45.0	45.0
Total Split (s)	69.0	69.0	69.0	69.0	69.0	69.0	14.4	61.0	61.0	46.6	46.6
Total Split (%)	53.1%	53.1%	53.1%	53.1%	53.1%	53.1%	11.1%	46.9%	46.9%	35.8%	35.8%
Yellow Time (s)	4.0	4.0	4.0	4.0	4.0	4.0	3.0	5.0	5.0	5.0	5.0
All-Red Time (s)	3.0	3.0	3.0	3.0	3.0	3.0	1.0	2.5	2.5	2.5	2.5
Lost Time Adjust (s)	0.0	0.0	0.0	0.0	0.0	0.0	0.0	0.0	0.0	0.0	0.0
Total Lost Time (s)	7.0	7.0	7.0	7.0	7.0	7.0	4.0	7.5	7.5	7.5	7.5
Lead/Lag							Lead			Lag	Lag
Lead-Lag Optimize?							Yes			Yes	Yes
Recall Mode	None	None	None	None	None	None	None	C-Max	C-Max	C-Max	C-Max
v/c Ratio	0.20	0.89	0.22	0.47	0.30	0.01	0.39	0.74	0.11	0.12	0.46
Control Delay	8.1	22.7	1.7	52.7	22.4	0.0	13.8	24.5	2.1	35.4	37.0
Queue Delay	0.0	0.0	0.0	0.0	0.0	0.0	0.0	0.0	0.0	0.0	0.0
Total Delay	8.1	22.7	1.7	52.7	22.4	0.0	13.8	24.5	2.1	35.4	37.0
Queue Length 50th (m)	3.9	186.5	1.0	4.5	39.8	0.0	8.6	38.6	0.0	3.6	58.2
Queue Length 95th (m)	m6.6	131.4	1.1	12.6	42.6	0.0	11.6	46.7	1.2	8.6	62.5
Internal Link Dist (m)		1983.6			47.6			491.8			90.6
Turn Bay Length (m)	30.0		31.0	30.0		14.0	61.0		30.0	15.0	
Base Capacity (vph)	396	1706	793	61	1723	815	387	819	671	164	1154
Starvation Cap Reductn	0	0	0	0	0	0	0	0	0	0	0
Spillback Cap Reductn	0	0	0	0	0	0	0	0	0	0	0
Storage Cap Reductn	0	0	0	0	0	0	0	0	0	0	0
Reduced v/c Ratio	0.19	0.85	0.21	0.44	0.29	0.01	0.39	0.74	0.11	0.12	0.46

Intersection Summary
 Cycle Length: 130
 Actuated Cycle Length: 130
 Offset: 0 (0%), Referenced to phase 2:NBTL and 6:SBTL, Start of Green
 Natural Cycle: 100
 Control Type: Actuated-Coordinated
 m Volume for 95th percentile queue is metered by upstream signal.

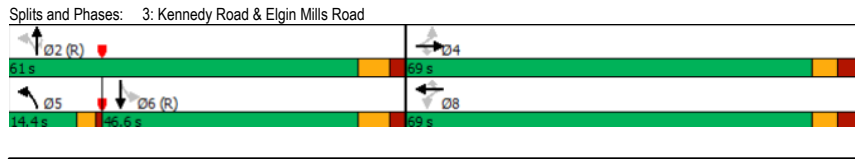

HCM Signalized Intersection Capacity Analysis
3: Kennedy Road & Elgin Mills Road

BG 2041 PM

	EBL	EBT	EBR	WBL	WBT	WBR	NBL	NBT	NBR	SBL	SBT	SBR
Lane Configurations	↔	↔↔	↔	↔	↔↔	↔	↔	↔	↔	↔	↔↔	↔
Traffic Volume (vph)	59	1123	131	21	380	7	115	470	56	15	391	16
Future Volume (vph)	59	1123	131	21	380	7	115	470	56	15	391	16
Ideal Flow (vphpl)	1900	1900	1900	1900	1900	1900	1900	1900	1900	1900	1900	1900
Total Lost time (s)	7.0	7.0	7.0	7.0	7.0	7.0	4.0	7.5	7.5	7.5	7.5	7.5
Lane Util. Factor	1.00	0.95	1.00	1.00	0.95	1.00	1.00	1.00	1.00	1.00	0.95	0.95
Frt	1.00	1.00	0.85	1.00	1.00	0.85	1.00	1.00	0.85	1.00	0.99	0.99
Fit Protected	0.95	1.00	1.00	0.95	1.00	1.00	0.95	1.00	1.00	0.95	1.00	1.00
Satd. Flow (prot)	1825	3579	1585	1825	3614	1633	1825	1902	1512	1825	3560	3560
Fit Permitted	0.43	1.00	1.00	0.07	1.00	1.00	0.33	1.00	1.00	0.26	1.00	1.00
Satd. Flow (perm)	831	3579	1585	129	3614	1633	635	1902	1512	507	3560	3560
Peak-hour factor, PHF	0.77	0.77	0.77	0.77	0.77	0.77	0.77	0.77	0.77	0.77	0.77	0.77
Adj. Flow (vph)	77	1458	170	27	494	9	149	610	73	19	508	21
RTOR Reduction (vph)	0	0	39	0	0	5	0	0	19	0	2	0
Lane Group Flow (vph)	77	1458	131	27	494	4	149	610	54	19	527	0
Heavy Vehicles (%)	0%	2%	3%	0%	1%	0%	0%	1%	8%	0%	2%	0%
Turn Type	Perm	NA	Perm	Perm	NA	Perm	pm+pt	NA	Perm	Perm	NA	NA
Protected Phases		4			8		5	2			6	
Permitted Phases	4		4	8		8	2		2	6		
Actuated Green, G (s)	59.5	59.5	59.5	59.5	59.5	59.5	56.0	56.0	56.0	42.0	42.0	42.0
Effective Green, g (s)	59.5	59.5	59.5	59.5	59.5	59.5	56.0	56.0	56.0	42.0	42.0	42.0
Actuated g/C Ratio	0.46	0.46	0.46	0.46	0.46	0.46	0.43	0.43	0.43	0.32	0.32	0.32
Clearance Time (s)	7.0	7.0	7.0	7.0	7.0	7.0	4.0	7.5	7.5	7.5	7.5	7.5
Vehicle Extension (s)	3.0	3.0	3.0	3.0	3.0	3.0	3.0	3.0	3.0	3.0	3.0	3.0
Lane Grp Cap (vph)	380	1638	725	59	1654	747	365	819	651	163	1150	1150
v/s Ratio Prot		c0.41			0.14		0.03	c0.32			0.15	
v/s Ratio Perm	0.09		0.08	0.21		0.00	0.14		0.04	0.04		
v/c Ratio	0.20	0.89	0.18	0.46	0.30	0.01	0.41	0.74	0.08	0.12	0.46	0.46
Uniform Delay, d1	21.1	32.3	20.8	24.2	22.1	19.2	23.7	31.0	21.8	31.0	35.0	35.0
Progression Factor	0.34	0.50	0.10	1.00	1.00	1.00	0.50	0.57	0.13	1.00	1.00	1.00
Incremental Delay, d2	0.2	5.4	0.1	5.5	0.1	0.0	0.7	6.0	0.2	1.5	1.3	1.3
Delay (s)	7.4	21.5	2.2	29.7	22.2	19.2	12.5	23.7	3.0	32.4	36.3	36.3
Level of Service	A	C	A	C	C	B	B	C	A	C	D	D
Approach Delay (s)		18.9			22.6			19.9			36.1	
Approach LOS		B			C			B			D	

Intersection Summary
 HCM 2000 Control Delay: 22.3
 HCM 2000 Level of Service: C
 HCM 2000 Volume to Capacity ratio: 0.85
 Actuated Cycle Length (s): 130.0
 Sum of lost time (s): 18.5
 Intersection Capacity Utilization: 113.5%
 ICU Level of Service: H
 Analysis Period (min): 15
 c Critical Lane Group

Timings

BG 2041 PM

4: Kennedy Road & Major Mackenzie Drive East

	↖	→	↘	↙	←	↖	↙	↘	↙	↘	↙	↘
Lane Group	EBL	EBT	EBR	WBL	WBT	WBR	NBL	NBT	NBR	SBL	SBT	SBR
Lane Configurations	↖	↖↖	↖	↖	↖↖	↖	↖	↖↖	↖	↖	↖↖	↖
Traffic Volume (vph)	100	2053	245	85	854	41	229	836	168	104	500	33
Future Volume (vph)	100	2053	245	85	854	41	229	836	168	104	500	33
Lane Group Flow (vph)	102	2095	250	87	871	42	234	853	171	106	510	34
Turn Type	pm+pt	NA	Perm	pm+pt	NA	Perm	pm+pt	NA	Perm	Perm	NA	Perm
Protected Phases	5	2		1	6		3	8			4	
Permitted Phases	2		2	6		6	8		8	4		4
Detector Phase	5	2	2	1	6	6	3	8	8	4	4	4
Switch Phase												
Minimum Initial (s)	7.0	30.0	30.0	7.0	30.0	30.0	7.0	10.0	10.0	10.0	10.0	10.0
Minimum Split (s)	11.0	47.5	47.5	11.0	47.5	47.5	11.0	38.5	38.5	38.5	38.5	38.5
Total Split (s)	12.0	63.0	63.0	12.0	63.0	63.0	15.0	55.0	55.0	40.0	40.0	40.0
Total Split (%)	9.2%	48.5%	48.5%	9.2%	48.5%	48.5%	11.5%	42.3%	42.3%	30.8%	30.8%	30.8%
Yellow Time (s)	3.0	5.0	5.0	3.0	5.0	5.0	3.0	5.0	5.0	5.0	5.0	5.0
All-Red Time (s)	1.0	2.5	2.5	1.0	2.5	2.5	1.0	2.5	2.5	2.5	2.5	2.5
Lost Time Adjust (s)	0.0	0.0	0.0	0.0	0.0	0.0	0.0	0.0	0.0	0.0	0.0	0.0
Total Lost Time (s)	4.0	7.5	7.5	4.0	7.5	7.5	4.0	7.5	7.5	7.5	7.5	7.5
Lead/Lag	Lead	Lag	Lag	Lead	Lag	Lag	Lead			Lag	Lag	Lag
Lead-Lag Optimize?	Yes	Yes	Yes	Yes	Yes	Yes	Yes			Yes	Yes	Yes
Recall Mode	None	C-Max	C-Max	None	C-Max	C-Max	None	Max	Max	Max	Max	Max
v/c Ratio	0.34	1.35	0.33	0.53	0.57	0.06	0.72	0.64	0.26	0.79	0.57	0.07
Control Delay	25.6	197.5	28.9	29.1	29.9	0.1	42.8	36.9	13.0	70.6	32.0	1.1
Queue Delay	0.0	0.0	0.0	0.0	0.0	0.0	0.0	0.0	0.0	0.0	0.0	0.0
Total Delay	25.6	197.5	28.9	29.1	29.9	0.1	42.8	36.9	13.0	70.6	32.0	1.1
Queue Length 50th (m)	17.6	~364.2	33.9	10.2	87.6	0.0	41.5	94.6	11.6	22.8	66.7	0.5
Queue Length 95th (m)	m14.3	m#228.8	m25.2	22.3	107.6	0.0	#63.9	116.3	28.0	#45.2	86.5	0.2
Internal Link Dist (m)		1995.6			145.1			116.0			395.2	
Turn Bay Length (m)	30.0		58.0	42.0		40.0	142.0		39.0	53.0		36.0
Base Capacity (vph)	305	1550	750	168	1533	750	323	1333	653	135	894	481
Starvation Cap Reductn	0	0	0	0	0	0	0	0	0	0	0	0
Spillback Cap Reductn	0	0	0	0	0	0	0	0	0	0	0	0
Storage Cap Reductn	0	0	0	0	0	0	0	0	0	0	0	0
Reduced v/c Ratio	0.33	1.35	0.33	0.52	0.57	0.06	0.72	0.64	0.26	0.79	0.57	0.07

Intersection Summary

Cycle Length: 130
 Actuated Cycle Length: 130
 Offset: 65 (50%), Referenced to phase 2:EBTL and 6:WBTL, Start of Green
 Natural Cycle: 150
 Control Type: Actuated-Coordinated
 ~ Volume exceeds capacity, queue is theoretically infinite.
 Queue shown is maximum after two cycles.
 # 95th percentile volume exceeds capacity, queue may be longer.
 Queue shown is maximum after two cycles.
 m Volume for 95th percentile queue is metered by upstream signal.

Splits and Phases: 4: Kennedy Road & Major Mackenzie Drive East

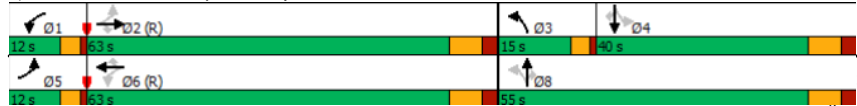

HCM Signalized Intersection Capacity Analysis

BG 2041 PM

4: Kennedy Road & Major Mackenzie Drive East

	↖	→	↘	↙	←	↖	↙	↘	↙	↘	↙	↘
Movement	EBL	EBT	EBR	WBL	WBT	WBR	NBL	NBT	NBR	SBL	SBT	SBR
Lane Configurations	↖	↖↖	↖	↖	↖↖	↖	↖	↖↖	↖	↖	↖↖	↖
Traffic Volume (vph)	100	2053	245	85	854	41	229	836	168	104	500	33
Future Volume (vph)	100	2053	245	85	854	41	229	836	168	104	500	33
Ideal Flow (vphpl)	1900	1900	1900	1900	1900	1900	1900	1900	1900	1900	1900	1900
Total Lost time (s)	4.0	7.5	7.5	4.0	7.5	7.5	4.0	7.5	7.5	7.5	7.5	7.5
Lane Util. Factor	1.00	0.95	1.00	1.00	0.95	1.00	1.00	0.95	1.00	0.95	1.00	0.95
Frbp, ped/bikes	1.00	1.00	0.99	1.00	1.00	0.99	1.00	0.99	1.00	1.00	0.99	1.00
Flpb, ped/bikes	1.00	1.00	1.00	1.00	1.00	1.00	1.00	1.00	1.00	1.00	1.00	1.00
Frt	1.00	1.00	0.85	1.00	1.00	0.85	1.00	1.00	0.85	1.00	1.00	0.85
Fit Protected	0.95	1.00	1.00	0.95	1.00	1.00	0.95	1.00	1.00	0.95	1.00	1.00
Satd. Flow (prot)	1825	3614	1611	1755	3579	1611	1807	3650	1611	1824	3579	1611
Fit Permitted	0.22	1.00	1.00	0.07	1.00	1.00	0.29	1.00	1.00	0.28	1.00	1.00
Satd. Flow (perm)	424	3614	1611	133	3579	1611	554	3650	1611	540	3579	1611
Peak-hour factor, PHF	0.98	0.98	0.98	0.98	0.98	0.98	0.98	0.98	0.98	0.98	0.98	0.98
Adj. Flow (vph)	102	2095	250	87	871	42	234	853	171	106	510	34
RTOR Reduction (vph)	0	0	60	0	0	24	0	0	65	0	0	26
Lane Group Flow (vph)	102	2095	190	87	871	18	234	853	106	106	510	9
Confl. Peds. (#/hr)	1		1	1		1	1		1	1		1
Heavy Vehicles (%)	0%	1%	0%	4%	2%	0%	1%	0%	0%	0%	2%	0%
Turn Type	pm+pt	NA	Perm	pm+pt	NA	Perm	pm+pt	NA	Perm	Perm	NA	Perm
Protected Phases	5	2		1	6		3	8			4	
Permitted Phases	2		2	6		6	8		8	4		4
Actuated Green, G (s)	63.6	55.8	55.8	63.4	55.7	55.7	47.5	47.5	47.5	32.5	32.5	32.5
Effective Green, g (s)	63.6	55.8	55.8	63.4	55.7	55.7	47.5	47.5	47.5	32.5	32.5	32.5
Actuated g/C Ratio	0.49	0.43	0.43	0.49	0.43	0.43	0.37	0.37	0.37	0.25	0.25	0.25
Clearance Time (s)	4.0	7.5	7.5	4.0	7.5	7.5	4.0	7.5	7.5	7.5	7.5	7.5
Vehicle Extension (s)	3.0	6.0	6.0	3.0	6.0	6.0	3.0	6.0	6.0	3.0	6.0	3.0
Lane Grp Cap (vph)	291	1551	691	160	1533	690	308	1333	588	135	894	402
v/s Ratio Prot	0.02	c0.58		c0.03	0.24		c0.06	0.23			0.14	
v/s Ratio Perm	0.15		0.12	0.23		0.01	c0.21		0.07	0.20		0.01
v/c Ratio	0.35	1.35	0.28	0.54	0.57	0.03	0.76	0.64	0.18	0.79	0.57	0.02
Uniform Delay, d1	19.4	37.1	24.0	28.7	28.1	21.5	32.3	34.2	28.0	45.5	42.6	36.8
Progression Factor	1.75	1.35	2.05	1.00	1.00	1.00	1.00	1.00	1.00	0.72	0.68	1.00
Incremental Delay, d2	0.1	158.2	0.1	3.7	1.5	0.1	10.3	2.4	0.7	35.3	2.6	0.1
Delay (s)	34.2	208.2	49.3	32.5	29.6	21.5	42.6	36.5	28.7	68.0	31.8	36.9
Level of Service	C	F	D	C	C	C	D	D	C	E	C	D
Approach Delay (s)		184.7			29.5		36.6			37.9		
Approach LOS		F			C		D			D		

Intersection Summary

HCM 2000 Control Delay: 103.1 HCM 2000 Level of Service: F
 HCM 2000 Volume to Capacity ratio: 1.07
 Actuated Cycle Length (s): 130.0 Sum of lost time (s): 23.0
 Intersection Capacity Utilization: 120.3% ICU Level of Service: H
 Analysis Period (min): 15
 c Critical Lane Group

Timings
5: Warden Avenue & E-W1

BG 2041 PM

	EBL	EBT	EBR	WBL	WBT	NBL	NBT	NBR	SBL	SBT	SBR
Lane Configurations	↖	↗	↘	↖	↗	↖	↗	↘	↖	↗	↘
Traffic Volume (vph)	22	162	229	135	161	260	1375	146	84	209	27
Future Volume (vph)	22	162	229	135	161	260	1375	146	84	209	27
Lane Group Flow (vph)	24	176	249	147	260	283	1495	159	91	227	29
Turn Type	Perm	NA	Perm	pm+pt	NA	pm+pt	NA	Perm	Perm	NA	Perm
Protected Phases		4		3	8	5	2		6		6
Permitted Phases	4		4	8		2		2	6		6
Detector Phase	4	4	4	3	8	5	2	2	6	6	6
Switch Phase											
Minimum Initial (s)	10.0	10.0	10.0	7.0	10.0	7.0	30.0	30.0	30.0	30.0	30.0
Minimum Split (s)	33.5	33.5	33.5	11.0	33.5	11.0	37.5	37.5	37.5	37.5	37.5
Total Split (s)	33.5	33.5	33.5	11.0	44.5	12.0	85.5	85.5	73.5	73.5	73.5
Total Split (%)	25.8%	25.8%	25.8%	8.5%	34.2%	9.2%	65.8%	65.8%	56.5%	56.5%	56.5%
Yellow Time (s)	5.0	5.0	5.0	3.0	5.0	3.0	5.0	5.0	5.0	5.0	5.0
All-Red Time (s)	2.5	2.5	2.5	1.0	2.5	1.0	2.5	2.5	2.5	2.5	2.5
Lost Time Adjust (s)	0.0	0.0	0.0	0.0	0.0	0.0	0.0	0.0	0.0	0.0	0.0
Total Lost Time (s)	7.5	7.5	7.5	4.0	7.5	4.0	7.5	7.5	7.5	7.5	7.5
Lead/Lag	Lag	Lag	Lag	Lead		Lead			Lag	Lag	Lag
Lead-Lag Optimize?	Yes	Yes	Yes	Yes		Yes			Yes	Yes	Yes
Recall Mode	None	None	None	None	None	None	C-Max	C-Max	C-Max	C-Max	C-Max
v/c Ratio	0.16	0.69	0.58	0.62	0.64	0.35	0.63	0.15	0.60	0.12	0.03
Control Delay	49.7	67.3	11.2	52.1	49.4	7.3	9.5	4.6	38.5	11.5	0.3
Queue Delay	0.0	0.0	0.0	0.0	0.0	0.0	0.0	0.0	0.0	0.0	0.0
Total Delay	49.7	67.3	11.2	52.1	49.4	7.3	9.5	4.6	38.5	11.5	0.3
Queue Length 50th (m)	5.5	43.7	0.0	31.2	56.6	12.8	41.2	3.4	9.5	9.7	0.2
Queue Length 95th (m)	13.1	64.0	22.4	46.8	79.6	m24.6	69.2	m10.8	#46.7	15.5	0.0
Internal Link Dist (m)		159.8			139.6		371.1			461.7	
Turn Bay Length (m)	30.0		73.0	48.0		80.0		34.0	48.0		30.0
Base Capacity (vph)	225	376	519	236	523	814	2379	1090	151	1956	922
Starvation Cap Reductn	0	0	0	0	0	0	0	0	0	0	0
Spillback Cap Reductn	0	0	0	0	0	0	0	0	0	0	0
Storage Cap Reductn	0	0	0	0	0	0	0	0	0	0	0
Reduced v/c Ratio	0.11	0.47	0.48	0.62	0.50	0.35	0.63	0.15	0.60	0.12	0.03

Intersection Summary

Cycle Length: 130
 Actuated Cycle Length: 130
 Offset: 0 (0%), Referenced to phase 2:NBTL and 6:SBTL, Start of Green
 Natural Cycle: 115
 Control Type: Actuated-Coordinated
 # 95th percentile volume exceeds capacity, queue may be longer.
 Queue shown is maximum after two cycles.
 m Volume for 95th percentile queue is metered by upstream signal.

Splits and Phases: 5: Warden Avenue & E-W1



052314_bg2041_Revised.syn
 R.J. Burnside & Associates

Synchro 11 Report
 03/23/2023 - Page 9

HCM Signalized Intersection Capacity Analysis
5: Warden Avenue & E-W1

BG 2041 PM

	EBL	EBT	EBR	WBL	WBT	WBR	NBL	NBT	NBR	SBL	SBT	SBR
Lane Configurations	↖	↗	↘	↖	↗	↘	↖	↗	↘	↖	↗	↘
Traffic Volume (vph)	22	162	229	135	161	78	260	1375	146	84	209	27
Future Volume (vph)	22	162	229	135	161	78	260	1375	146	84	209	27
Ideal Flow (vphpl)	1900	1900	1900	1900	1900	1900	1900	1900	1900	1900	1900	1900
Total Lost time (s)	7.5	7.5	7.5	4.0	7.5		4.0	7.5	7.5	7.5	7.5	7.5
Lane Util. Factor	1.00	1.00	1.00	1.00	1.00		1.00	0.95	1.00	1.00	0.95	1.00
Frt	1.00	1.00	0.85	1.00	0.95		1.00	1.00	0.85	1.00	1.00	0.85
Fit Protected	0.95	1.00	1.00	0.95	1.00		0.95	1.00	1.00	0.95	1.00	1.00
Satd. Flow (prot)	1789	1883	1601	1789	1791		1789	3579	1601	1789	3579	1601
Fit Permitted	0.60	1.00	1.00	0.39	1.00		0.58	1.00	1.00	0.15	1.00	1.00
Satd. Flow (perm)	1127	1883	1601	728	1791		1088	3579	1601	278	3579	1601
Peak-hour factor, PHF	0.92	0.92	0.92	0.92	0.92	0.92	0.92	0.92	0.92	0.92	0.92	0.92
Adj. Flow (vph)	24	176	249	147	175	85	283	1495	159	91	227	29
RTOR Reduction (vph)	0	0	215	0	15	0	0	0	26	0	0	13
Lane Group Flow (vph)	24	176	34	147	245	0	283	1495	133	91	227	16
Turn Type	Perm	NA	Perm	pm+pt	NA		pm+pt	NA	Perm	Perm	NA	Perm
Protected Phases		4		3	8		5	2		6		6
Permitted Phases	4		4	8			2		2	6		6
Actuated Green, G (s)	17.6	17.6	17.6	28.6	28.6		86.4	86.4	86.4	71.0	71.0	71.0
Effective Green, g (s)	17.6	17.6	17.6	28.6	28.6		86.4	86.4	86.4	71.0	71.0	71.0
Actuated g/C Ratio	0.14	0.14	0.14	0.22	0.22		0.66	0.66	0.66	0.55	0.55	0.55
Clearance Time (s)	7.5	7.5	7.5	4.0	7.5		4.0	7.5	7.5	7.5	7.5	7.5
Vehicle Extension (s)	3.0	3.0	3.0	3.0	3.0		3.0	3.0	3.0	3.0	3.0	3.0
Lane Grp Cap (vph)	152	254	216	217	394		784	2378	1064	151	1954	874
v/s Ratio Prot		0.09		0.04	c0.14		0.03	c0.42			0.06	
v/s Ratio Perm	0.02		0.02	c0.11			0.21		0.08	0.33		0.01
v/c Ratio	0.16	0.69	0.16	0.68	0.62		0.36	0.63	0.13	0.60	0.12	0.02
Uniform Delay, d1	49.7	53.6	49.6	45.3	45.8		8.8	12.6	8.0	20.0	14.3	13.5
Progression Factor	1.00	1.00	1.00	1.00	1.00		0.81	0.65	0.93	0.84	0.75	1.00
Incremental Delay, d2	0.5	7.9	0.3	8.1	3.0		0.2	0.8	0.1	16.4	0.1	0.0
Delay (s)	50.1	61.5	50.0	53.4	48.9		7.3	9.0	7.6	33.2	10.8	13.6
Level of Service	D	E	D	D	D		A	A	A	C	B	B
Approach Delay (s)		54.5			50.5			8.6			16.9	
Approach LOS		D			D			A			B	

Intersection Summary

HCM 2000 Control Delay: 21.5, HCM 2000 Level of Service: C
 HCM 2000 Volume to Capacity ratio: 0.68
 Actuated Cycle Length (s): 130.0, Sum of lost time (s): 23.0
 Intersection Capacity Utilization: 109.6%, ICU Level of Service: H
 Analysis Period (min): 15
 c Critical Lane Group

052314_bg2041_Revised.syn
 R.J. Burnside & Associates

Synchro 11 Report
 03/23/2023 - Page 10

Timings
6: Warden Avenue & E-W2

BG 2041 PM

	EBL	EBT	WBL	WBT	NBL	NBT	NBR	SBL	SBT	SBR
Lane Configurations	↔	↔	↔	↔	↔	↔	↔	↔	↔	↔
Traffic Volume (vph)	6	59	64	82	150	1822	46	8	555	10
Future Volume (vph)	6	59	64	82	150	1822	46	8	555	10
Lane Group Flow (vph)	7	162	70	93	163	1980	50	9	603	11
Turn Type	Perm	NA	pm+pt	NA	pm+pt	NA	Perm	Perm	NA	Perm
Protected Phases		4	3	8	5	2			6	
Permitted Phases	4		8		2		2	6		6
Detector Phase	4	4	3	8	5	2	2	6	6	6
Switch Phase										
Minimum Initial (s)	10.0	10.0	7.0	10.0	7.0	30.0	30.0	30.0	30.0	30.0
Minimum Split (s)	33.5	33.5	11.0	33.5	11.0	47.5	47.5	47.5	47.5	47.5
Total Split (s)	33.5	33.5	11.0	44.5	11.0	85.5	85.5	74.5	74.5	74.5
Total Split (%)	25.8%	25.8%	8.5%	34.2%	8.5%	65.8%	65.8%	57.3%	57.3%	57.3%
Yellow Time (s)	5.0	5.0	3.0	5.0	3.0	5.0	5.0	5.0	5.0	5.0
All-Red Time (s)	2.5	2.5	1.0	2.5	1.0	2.5	2.5	2.5	2.5	2.5
Lost Time Adjust (s)	0.0	0.0	0.0	0.0	0.0	0.0	0.0	0.0	0.0	0.0
Total Lost Time (s)	7.5	7.5	4.0	7.5	4.0	7.5	7.5	7.5	7.5	7.5
Lead/Lag	Lag	Lag	Lead		Lead		Lag	Lag	Lag	
Lead-Lag Optimize?	Yes	Yes	Yes		Yes		Yes	Yes	Yes	
Recall Mode	None	None	None	None	None	C-Max	C-Max	C-Max	C-Max	C-Max
v/c Ratio	0.05	0.68	0.35	0.28	0.27	0.78	0.04	0.13	0.28	0.01
Control Delay	49.3	51.4	44.8	44.8	7.0	13.6	1.2	19.8	13.2	0.0
Queue Delay	0.0	0.0	0.0	0.0	0.0	0.0	0.0	0.0	0.0	0.0
Total Delay	49.3	51.4	44.8	44.8	7.0	13.6	1.2	19.8	13.2	0.0
Queue Length 50th (m)	1.6	27.2	14.7	20.0	11.5	120.2	0.0	1.1	39.4	0.0
Queue Length 95th (m)	6.0	48.2	25.9	33.3	m20.9	134.8	m0.5	m3.4	58.9	m0.0
Internal Link Dist (m)		167.0		182.8		414.0			371.1	
Turn Bay Length (m)	30.0		31.0		26.0		30.0	15.0		30.0
Base Capacity (vph)	262	384	202	534	606	2526	1150	69	2158	1007
Starvation Cap Reductn	0	0	0	0	0	0	0	0	0	0
Spillback Cap Reductn	0	0	0	0	0	0	0	0	0	0
Storage Cap Reductn	0	0	0	0	0	0	0	0	0	0
Reduced v/c Ratio	0.03	0.42	0.35	0.17	0.27	0.78	0.04	0.13	0.28	0.01

Intersection Summary

Cycle Length: 130
 Actuated Cycle Length: 130
 Offset: 0 (0%), Referenced to phase 2:NBTL and 6:SBTL, Start of Green
 Natural Cycle: 115
 Control Type: Actuated-Coordinated
 m Volume for 95th percentile queue is metered by upstream signal.

Splits and Phases: 6: Warden Avenue & E-W2

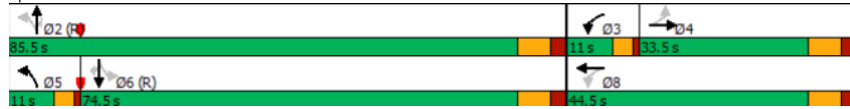

HCM Signalized Intersection Capacity Analysis
6: Warden Avenue & E-W2

BG 2041 PM

	EBL	EBT	EBR	WBL	WBT	WBR	NBL	NBT	NBR	SBL	SBT	SBR
Lane Configurations	↔	↔	↔	↔	↔	↔	↔	↔	↔	↔	↔	↔
Traffic Volume (vph)	6	59	90	64	82	4	150	1822	46	8	555	10
Future Volume (vph)	6	59	90	64	82	4	150	1822	46	8	555	10
Ideal Flow (vphpl)	1900	1900	1900	1900	1900	1900	1900	1900	1900	1900	1900	1900
Total Lost time (s)	7.5	7.5		4.0	7.5		4.0	7.5	7.5	7.5	7.5	7.5
Lane Util. Factor	1.00	1.00		1.00	1.00		1.00	0.95	1.00	1.00	0.95	1.00
Frnt	1.00	0.91		1.00	0.99		1.00	1.00	0.85	1.00	1.00	0.85
Fit Protected	0.95	1.00		0.95	1.00		0.95	1.00	1.00	0.95	1.00	1.00
Satd. Flow (prot)	1789	1713		1789	1871		1789	3579	1601	1789	3579	1601
Fit Permitted	0.70	1.00		0.37	1.00		0.38	1.00	1.00	0.06	1.00	1.00
Satd. Flow (perm)	1312	1713		701	1871		723	3579	1601	115	3579	1601
Peak-hour factor, PHF	0.92	0.92	0.92	0.92	0.92	0.92	0.92	0.92	0.92	0.92	0.92	0.92
Adj. Flow (vph)	7	64	98	70	89	4	163	1980	50	9	603	11
RTOR Reduction (vph)	0	47	0	0	2	0	0	15	0	0	4	0
Lane Group Flow (vph)	7	115	0	70	91	0	163	1980	35	9	603	7
Turn Type	Perm	NA		pm+pt	NA		pm+pt	NA	Perm	Perm	NA	Perm
Protected Phases		4		3	8		5	2			6	
Permitted Phases	4			8			2		2	6		6
Actuated Green, G (s)	14.4	14.4		24.0	24.0		91.0	91.0	91.0	77.6	77.6	77.6
Effective Green, g (s)	14.4	14.4		24.0	24.0		91.0	91.0	91.0	77.6	77.6	77.6
Actuated g/C Ratio	0.11	0.11		0.18	0.18		0.70	0.70	0.70	0.60	0.60	0.60
Clearance Time (s)	7.5	7.5		4.0	7.5		4.0	7.5	7.5	7.5	7.5	7.5
Vehicle Extension (s)	3.0	3.0		3.0	3.0		3.0	3.0	3.0	3.0	3.0	3.0
Lane Grp Cap (vph)	145	189		176	345		583	2505	1120	68	2136	955
v/s Ratio Prot		c0.07		c0.02	0.05		0.02	c0.55			0.17	
v/s Ratio Perm	0.01			0.06			0.18		0.02	0.08		0.00
v/c Ratio	0.05	0.61		0.40	0.26		0.28	0.79	0.03	0.13	0.28	0.01
Uniform Delay, d1	51.7	55.1		45.2	45.4		6.7	13.1	6.0	11.5	12.7	10.6
Progression Factor	1.00	1.00		1.00	1.00		1.01	0.81	1.31	0.95	0.94	1.00
Incremental Delay, d2	0.1	5.4		1.5	0.4		0.2	1.9	0.0	3.8	0.3	0.0
Delay (s)	51.8	60.5		46.7	45.8		7.0	12.6	7.9	14.7	12.3	10.6
Level of Service	D	E		D	D		A	B	A	B	B	B
Approach Delay (s)		60.2			46.2			12.1				12.3
Approach LOS		E			D			B				B

Intersection Summary

HCM 2000 Control Delay: 16.5, HCM 2000 Level of Service: B
 HCM 2000 Volume to Capacity ratio: 0.78
 Actuated Cycle Length (s): 130.0, Sum of lost time (s): 23.0
 Intersection Capacity Utilization: 117.0%, ICU Level of Service: H
 Analysis Period (min): 15
 c Critical Lane Group

Timings
7: Warden Avenue & N-S2

BG 2041 PM

	EBL	EBT	WBL	WBT	NBL	NBT	NBR	SBL	SBT	SBR
Lane Configurations	↔	↔	↔	↔	↔	↔	↔	↔	↔	↔
Traffic Volume (vph)	10	46	38	29	162	1947	52	33	651	25
Future Volume (vph)	10	46	38	29	162	1947	52	33	651	25
Lane Group Flow (vph)	11	125	41	41	176	2116	57	36	708	27
Turn Type	Perm	NA	Perm	NA	Perm	NA	Perm	Perm	NA	Perm
Protected Phases		4		8		2		2	6	6
Permitted Phases	4		8		2		2	6		6
Detector Phase	4	4	8	8	2	2	2	6	6	6
Switch Phase										
Minimum Initial (s)	10.0	10.0	10.0	10.0	30.0	30.0	30.0	30.0	30.0	30.0
Minimum Split (s)	30.5	30.5	30.5	30.5	34.5	34.5	34.5	34.5	34.5	34.5
Total Split (s)	30.5	30.5	30.5	30.5	99.5	99.5	99.5	99.5	99.5	99.5
Total Split (%)	23.5%	23.5%	23.5%	23.5%	76.5%	76.5%	76.5%	76.5%	76.5%	76.5%
Yellow Time (s)	3.5	3.5	3.5	3.5	3.5	3.5	3.5	3.5	3.5	3.5
All-Red Time (s)	1.0	1.0	1.0	1.0	1.0	1.0	1.0	1.0	1.0	1.0
Lost Time Adjust (s)	0.0	0.0	0.0	0.0	0.0	0.0	0.0	0.0	0.0	0.0
Total Lost Time (s)	4.5	4.5	4.5	4.5	4.5	4.5	4.5	4.5	4.5	4.5
Lead/Lag										
Lead-Lag Optimize?										
Recall Mode	None	None	None	None	C-Max	C-Max	C-Max	C-Max	C-Max	C-Max
v/c Ratio	0.09	0.60	0.53	0.23	0.29	0.71	0.04	0.34	0.24	0.02
Control Delay	53.4	44.7	79.2	46.8	4.0	6.2	1.4	14.3	1.8	0.6
Queue Delay	0.0	0.0	0.0	0.0	0.0	0.5	0.0	0.0	0.0	0.0
Total Delay	53.4	44.7	79.2	46.8	4.0	6.7	1.4	14.3	1.8	0.6
Queue Length 50th (m)	2.7	18.2	10.3	7.8	7.0	81.4	1.0	1.0	8.5	0.3
Queue Length 95th (m)	8.4	37.2	21.7	18.2	17.4	135.6	3.7	8.9	15.9	m0.5
Internal Link Dist (m)		78.5		142.8		263.5			414.0	
Turn Bay Length (m)	30.0		30.0		30.0		15.0		30.0	
Base Capacity (vph)	275	384	166	371	597	2992	1343	105	2992	1343
Starvation Cap Reductn	0	0	0	0	0	417	0	0	0	0
Spillback Cap Reductn	0	0	0	0	0	0	0	0	0	0
Storage Cap Reductn	0	0	0	0	0	0	0	0	0	0
Reduced v/c Ratio	0.04	0.33	0.25	0.11	0.29	0.82	0.04	0.34	0.24	0.02

Intersection Summary

Cycle Length: 130
 Actuated Cycle Length: 130
 Offset: 0 (0%), Referenced to phase 2:NBT and 6:SBTL, Start of Green
 Natural Cycle: 90
 Control Type: Actuated-Coordinated
 m Volume for 95th percentile queue is metered by upstream signal.

Splits and Phases: 7: Warden Avenue & N-S2

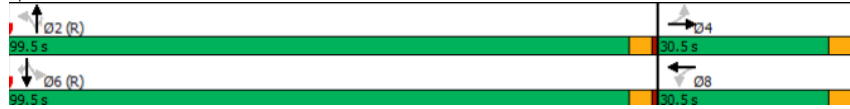

HCM Signalized Intersection Capacity Analysis
7: Warden Avenue & N-S2

BG 2041 PM

	EBL	EBT	EBR	WBL	WBT	WBR	NBL	NBT	NBR	SBL	SBT	SBR
Lane Configurations	↔	↔	↔	↔	↔	↔	↔	↔	↔	↔	↔	↔
Traffic Volume (vph)	10	46	69	38	29	8	162	1947	52	33	651	25
Future Volume (vph)	10	46	69	38	29	8	162	1947	52	33	651	25
Ideal Flow (vphpl)	1900	1900	1900	1900	1900	1900	1900	1900	1900	1900	1900	1900
Total Lost time (s)	4.5	4.5		4.5	4.5		4.5	4.5	4.5	4.5	4.5	4.5
Lane Util. Factor	1.00	1.00		1.00	1.00		1.00	0.95	1.00	1.00	0.95	1.00
Fr't	1.00	0.91		1.00	0.97		1.00	1.00	0.85	1.00	1.00	0.85
Fit Protected	0.95	1.00		0.95	1.00		0.95	1.00	1.00	0.95	1.00	1.00
Satd. Flow (prot)	1789	1714		1789	1821		1789	3579	1601	1789	3579	1601
Fit Permitted	0.73	1.00		0.44	1.00		0.38	1.00	1.00	0.07	1.00	1.00
Satd. Flow (perm)	1376	1714		831	1821		713	3579	1601	125	3579	1601
Peak-hour factor, PHF	0.92	0.92	0.92	0.92	0.92	0.92	0.92	0.92	0.92	0.92	0.92	0.92
Adj. Flow (vph)	11	50	75	41	32	9	176	2116	57	36	708	27
RTOR Reduction (vph)	0	47	0	0	8	0	0	0	4	0	0	4
Lane Group Flow (vph)	11	78	0	41	33	0	176	2116	53	36	708	23
Turn Type	Perm	NA		Perm	NA		Perm	NA	Perm	Perm	NA	Perm
Protected Phases		4			8		2		2	6		6
Permitted Phases	4			8			2		2	6		6
Actuated Green, G (s)	12.3	12.3		12.3	12.3		108.7	108.7	108.7	108.7	108.7	108.7
Effective Green, g (s)	12.3	12.3		12.3	12.3		108.7	108.7	108.7	108.7	108.7	108.7
Actuated g/C Ratio	0.09	0.09		0.09	0.09		0.84	0.84	0.84	0.84	0.84	0.84
Clearance Time (s)	4.5	4.5		4.5	4.5		4.5	4.5	4.5	4.5	4.5	4.5
Vehicle Extension (s)	3.0	3.0		3.0	3.0		3.0	3.0	3.0	3.0	3.0	3.0
Lane Grp Cap (vph)	130	162		78	172		596	2992	1338	104	2992	1338
v/s Ratio Prot		0.05			0.02			c0.59			0.20	
v/s Ratio Perm	0.01			c0.05			0.25		0.03	0.29		0.01
v/c Ratio	0.08	0.48		0.53	0.19		0.30	0.71	0.04	0.35	0.24	0.02
Uniform Delay, d1	53.7	55.8		56.1	54.3		2.3	4.3	1.8	2.5	2.2	1.8
Progression Factor	1.00	1.00		1.00	1.00		1.00	1.00	1.00	1.39	0.71	0.73
Incremental Delay, d2	0.3	2.2		6.3	0.5		1.3	1.4	0.1	8.6	0.2	0.0
Delay (s)	54.0	58.1		62.3	54.8		3.6	5.7	1.9	12.0	1.7	1.3
Level of Service	D	E		E	D		A	A	A	B	A	A
Approach Delay (s)		57.7			58.6			5.5			2.2	
Approach LOS		E			E			A			A	

Intersection Summary

HCM 2000 Control Delay: 8.1, HCM 2000 Level of Service: A
 HCM 2000 Volume to Capacity ratio: 0.69
 Actuated Cycle Length (s): 130.0, Sum of lost time (s): 9.0
 Intersection Capacity Utilization: 98.8%, ICU Level of Service: F
 Analysis Period (min): 15
 c Critical Lane Group

Timings
8: Warden Avenue & E-W3

BG 2041 PM

	↖	→	↙	←	↘	↑	↗	↓	↖	
Lane Group	EBL	EBT	WBL	WBT	NBL	NBT	NBR	SBL	SBT	SBR
Lane Configurations	↖	↗	↖	↗	↖	↗	↖	↗	↖	↗
Traffic Volume (vph)	90	160	61	125	92	1946	112	88	593	77
Future Volume (vph)	90	160	61	125	92	1946	112	88	593	77
Lane Group Flow (vph)	98	229	66	228	100	2115	122	96	645	84
Turn Type	pm+pt	NA	Perm	NA	Perm	NA	Perm	pm+pt	NA	Perm
Protected Phases	7	4	8	8	2	2	2	1	6	6
Permitted Phases	4		8		2		2	6		6
Detector Phase	7	4	8	8	2	2	2	1	6	6
Switch Phase										
Minimum Initial (s)	5.0	10.0	10.0	10.0	30.0	30.0	30.0	5.0	30.0	30.0
Minimum Split (s)	9.5	33.5	33.5	33.5	37.5	37.5	37.5	9.5	37.5	37.5
Total Split (s)	9.5	35.0	33.5	33.5	85.5	85.5	85.5	9.5	95.0	95.0
Total Split (%)	6.9%	25.4%	24.3%	24.3%	62.0%	62.0%	62.0%	6.9%	68.8%	68.8%
Yellow Time (s)	3.5	5.0	5.0	5.0	5.0	5.0	5.0	3.5	5.0	5.0
All-Red Time (s)	1.0	2.5	2.5	2.5	2.5	2.5	2.5	1.0	2.5	2.5
Lost Time Adjust (s)	0.0	0.0	0.0	0.0	0.0	0.0	0.0	0.0	0.0	0.0
Total Lost Time (s)	4.5	7.5	7.5	7.5	7.5	7.5	7.5	4.5	7.5	7.5
Lead/Lag	Lead		Lag	Lag	Lag	Lag	Lag	Lead		
Lead-Lag Optimize?	Yes		Yes	Yes	Yes	Yes	Yes	Yes		
Recall Mode	None	None	None	None	C-Max	C-Max	C-Max	None	C-Max	C-Max
v/c Ratio	0.57	0.56	0.38	0.80	0.22	1.01	0.12	0.64	0.27	0.08
Control Delay	55.6	50.5	57.7	70.9	16.0	50.4	3.5	39.4	9.9	2.0
Queue Delay	0.0	0.0	0.0	0.0	0.0	0.0	0.0	0.0	0.0	0.0
Total Delay	55.6	50.5	57.7	70.9	16.0	50.4	3.5	39.4	9.9	2.0
Queue Length 50th (m)	21.5	53.1	16.3	54.8	13.1	~327.9	1.7	9.3	35.0	0.0
Queue Length 95th (m)	35.4	76.2	30.2	81.1	24.2	#369.2	10.5	#40.9	48.6	6.0
Internal Link Dist (m)		9.5		157.9		372.3			263.5	
Turn Bay Length (m)	30.0		30.0		21.0		30.0	27.0		30.0
Base Capacity (vph)	171	475	218	351	449	2098	983	150	2403	1102
Starvation Cap Reductn	0	0	0	0	0	0	0	0	0	0
Spillback Cap Reductn	0	0	0	0	0	0	0	0	0	0
Storage Cap Reductn	0	0	0	0	0	0	0	0	0	0
Reduced v/c Ratio	0.57	0.48	0.30	0.65	0.22	1.01	0.12	0.64	0.27	0.08

Intersection Summary

Cycle Length: 138
 Actuated Cycle Length: 138
 Offset: 0 (0%), Referenced to phase 2:NBTL and 6:SBTL, Start of Green
 Natural Cycle: 150
 Control Type: Actuated-Coordinated
 ~ Volume exceeds capacity, queue is theoretically infinite.
 Queue shown is maximum after two cycles.
 # 95th percentile volume exceeds capacity, queue may be longer.
 Queue shown is maximum after two cycles.

Splits and Phases: 8: Warden Avenue & E-W3



R.J. Burnside & Associates

03/23/2023 - Page 15

HCM Signalized Intersection Capacity Analysis
8: Warden Avenue & E-W3

BG 2041 PM

	↖	→	↙	←	↘	↑	↗	↓	↖			
Movement	EBL	EBT	EBR	WBL	WBT	WBR	NBL	NBT	NBR	SBL	SBT	SBR
Lane Configurations	↖	↗		↖	↗		↖	↗	↖	↗	↖	↗
Traffic Volume (vph)	90	160	51	61	125	85	92	1946	112	88	593	77
Future Volume (vph)	90	160	51	61	125	85	92	1946	112	88	593	77
Ideal Flow (vphpl)	1900	1900	1900	1900	1900	1900	1900	1900	1900	1900	1900	1900
Total Lost time (s)	4.5	7.5		7.5	7.5		7.5	7.5	7.5	4.5	7.5	7.5
Lane Util. Factor	1.00	1.00		1.00	1.00		1.00	0.95	1.00	1.00	0.95	1.00
Fr't	1.00	0.96		1.00	0.94		1.00	1.00	0.85	1.00	1.00	0.85
Flt Protected	0.95	1.00		0.95	1.00		0.95	1.00	1.00	0.95	1.00	1.00
Satd. Flow (prot)	1789	1816		1789	1769		1789	3579	1601	1789	3579	1601
Flt Permitted	0.28	1.00		0.62	1.00		0.41	1.00	1.00	0.05	1.00	1.00
Satd. Flow (perm)	518	1816		1160	1769		766	3579	1601	88	3579	1601
Peak-hour factor, PHF	0.92	0.92	0.92	0.92	0.92	0.92	0.92	0.92	0.92	0.92	0.92	0.92
Adj. Flow (vph)	98	174	55	66	136	92	100	2115	122	96	645	84
RTOR Reduction (vph)	0	9	0	0	19	0	0	0	44	0	0	28
Lane Group Flow (vph)	98	220	0	66	209	0	100	2115	78	96	645	56
Turn Type	pm+pt	NA		Perm	NA		Perm	NA	Perm	pm+pt	NA	Perm
Protected Phases	7	4			8			2		1	6	
Permitted Phases	4				8			2		6		6
Actuated Green, G (s)	30.3	30.3		20.8	20.8		81.0	81.0	81.0	92.7	92.7	92.7
Effective Green, g (s)	30.3	30.3		20.8	20.8		81.0	81.0	81.0	92.7	92.7	92.7
Actuated g/C Ratio	0.22	0.22		0.15	0.15		0.59	0.59	0.59	0.67	0.67	0.67
Clearance Time (s)	4.5	7.5		7.5	7.5		7.5	7.5	7.5	4.5	7.5	7.5
Vehicle Extension (s)	3.0	3.0		3.0	3.0		3.0	3.0	3.0	3.0	3.0	3.0
Lane Grp Cap (vph)	159	398		174	266		449	2100	939	147	2404	1075
v/s Ratio Prot	0.02	c0.12			c0.12			c0.59		c0.03	0.18	
v/s Ratio Perm	0.11			0.06			0.13		0.05	0.40		0.04
v/c Ratio	0.62	0.55		0.38	0.79		0.22	1.01	0.08	0.65	0.27	0.05
Uniform Delay, d1	47.7	47.8		52.8	56.5		13.5	28.5	12.4	35.7	9.1	7.7
Progression Factor	1.00	1.00		1.00	1.00		1.00	1.00	1.00	1.00	1.00	1.00
Incremental Delay, d2	6.9	1.7		1.4	14.2		1.1	21.4	0.2	10.0	0.3	0.1
Delay (s)	54.6	49.5		54.2	70.7		14.7	49.9	12.5	45.6	9.3	7.8
Level of Service	D	D		D	E		B	D	B	D	A	A
Approach Delay (s)		51.0			67.0			46.4			13.4	
Approach LOS		D			E			D			B	

Intersection Summary

HCM 2000 Control Delay: 41.2, HCM 2000 Level of Service: D
 HCM 2000 Volume to Capacity ratio: 0.93
 Actuated Cycle Length (s): 138.0, Sum of lost time (s): 24.0
 Intersection Capacity Utilization: 101.0%, ICU Level of Service: G
 Analysis Period (min): 15
 c Critical Lane Group

052314_bg2041_Revised.syn
R.J. Burnside & Associates

Synchro 11 Report
03/23/2023 - Page 16

Timings
9: Kennedy Road & E-W1

BG 2041 PM

	↖	→	←	↙	↑	↘	↓	↗	
Lane Group	EBL	EBT	WBT	NBL	NBT	NBR	SBL	SBT	SBR
Lane Configurations	↖	↗	↗	↖	↖	↖	↗	↗	↗
Traffic Volume (vph)	6	55	74	114	636	25	5	526	11
Future Volume (vph)	6	55	74	114	636	25	5	526	11
Lane Group Flow (vph)	7	134	80	124	691	27	5	572	12
Turn Type	Perm	NA	NA	Perm	NA	Perm	Perm	NA	Perm
Protected Phases		4	8		2		6		6
Permitted Phases	4			2		2	6		6
Detector Phase	4	4	8	2	2	2	6	6	6
Switch Phase									
Minimum Initial (s)	10.0	10.0	10.0	30.0	30.0	30.0	10.0	10.0	10.0
Minimum Split (s)	33.5	33.5	33.5	40.0	40.0	40.0	40.0	40.0	40.0
Total Split (s)	41.0	41.0	41.0	89.0	89.0	89.0	89.0	89.0	89.0
Total Split (%)	31.5%	31.5%	31.5%	68.5%	68.5%	68.5%	68.5%	68.5%	68.5%
Yellow Time (s)	5.0	5.0	5.0	5.0	5.0	5.0	5.0	5.0	5.0
All-Red Time (s)	2.5	2.5	2.5	2.5	2.5	2.5	2.5	2.5	2.5
Lost Time Adjust (s)	0.0	0.0	0.0	0.0	0.0	0.0	0.0	0.0	0.0
Total Lost Time (s)	7.5	7.5	7.5	7.5	7.5	7.5	7.5	7.5	7.5
Lead/Lag									
Lead-Lag Optimize?									
Recall Mode	None	None	None	C-Max	C-Max	C-Max	C-Max	C-Max	C-Max
v/c Ratio	0.07	0.41	0.29	0.19	0.24	0.02	0.01	0.20	0.01
Control Delay	57.0	30.8	59.2	10.7	11.3	3.4	1.6	1.9	0.0
Queue Delay	0.0	0.0	0.0	0.0	0.0	0.0	0.0	0.0	0.0
Total Delay	57.0	30.8	59.2	10.7	11.3	3.4	1.6	1.9	0.0
Queue Length 50th (m)	1.7	7.7	10.3	23.8	73.0	1.6	0.2	9.3	0.0
Queue Length 95th (m)	6.6	17.9	18.4	42.4	92.1	4.8	m0.3	9.5	m0.0
Internal Link Dist (m)		139.9	134.7		466.1			491.8	
Turn Bay Length (m)	30.0			29.0		30.0	15.0		30.0
Base Capacity (vph)	340	900	922	663	2885	1298	591	2885	1298
Starvation Cap Reductn	0	0	0	0	0	0	0	0	0
Spillback Cap Reductn	0	0	0	0	0	0	0	0	0
Storage Cap Reductn	0	0	0	0	0	0	0	0	0
Reduced v/c Ratio	0.02	0.15	0.09	0.19	0.24	0.02	0.01	0.20	0.01

Intersection Summary

Cycle Length: 130
 Actuated Cycle Length: 130
 Offset: 0 (0%), Referenced to phase 2:NBTL and 6:SBTL, Start of Green
 Natural Cycle: 75
 Control Type: Actuated-Coordinated
 m Volume for 95th percentile queue is metered by upstream signal.

Splits and Phases: 9: Kennedy Road & E-W1



HCM Signalized Intersection Capacity Analysis
9: Kennedy Road & E-W1

BG 2041 PM

	↖	→	↘	↙	←	↗	↖	↗	↗	↖	↗	↖	↗
Movement	EBL	EBT	EBR	WBL	WBT	WBR	NBL	NBT	NBR	SBL	SBT	SBR	SBR
Lane Configurations	↖	↗	↘	↖	↗	↘	↖	↗	↘	↖	↗	↘	↘
Traffic Volume (vph)	6	55	68	0	74	0	114	636	25	5	526	11	11
Future Volume (vph)	6	55	68	0	74	0	114	636	25	5	526	11	11
Ideal Flow (vphpl)	1900	1900	1900	1900	1900	1900	1900	1900	1900	1900	1900	1900	1900
Total Lost time (s)	7.5	7.5			7.5		7.5	7.5	7.5	7.5	7.5	7.5	7.5
Lane Util. Factor	1.00	0.95			0.95		1.00	0.95	1.00	1.00	0.95	1.00	1.00
Frnt	1.00	0.92			1.00		1.00	1.00	0.85	1.00	1.00	0.85	1.00
Fit Protected	0.95	1.00			1.00		0.95	1.00	1.00	0.95	1.00	1.00	1.00
Satd. Flow (prot)	1789	3282			3579		1789	3579	1601	1789	3579	1601	1601
Fit Permitted	0.70	1.00			1.00		0.44	1.00	1.00	0.39	1.00	1.00	1.00
Satd. Flow (perm)	1323	3282			3579		823	3579	1601	732	3579	1601	1601
Peak-hour factor, PHF	0.92	0.92	0.92	0.92	0.92	0.92	0.92	0.92	0.92	0.92	0.92	0.92	0.92
Adj. Flow (vph)	7	60	74	0	80	0	124	691	27	5	572	12	12
RTOR Reduction (vph)	0	68	0	0	0	0	0	0	5	0	0	2	2
Lane Group Flow (vph)	7	66	0	0	80	0	124	691	22	5	572	10	10
Turn Type	Perm	NA			Perm	NA	Perm	NA	Perm	Perm	NA	Perm	Perm
Protected Phases		4			8		2		2	6		6	6
Permitted Phases	4			8			2		2	6		6	6
Actuated Green, G (s)	10.2	10.2			10.2		104.8	104.8	104.8	104.8	104.8	104.8	104.8
Effective Green, g (s)	10.2	10.2			10.2		104.8	104.8	104.8	104.8	104.8	104.8	104.8
Actuated g/C Ratio	0.08	0.08			0.08		0.81	0.81	0.81	0.81	0.81	0.81	0.81
Clearance Time (s)	7.5	7.5			7.5		7.5	7.5	7.5	7.5	7.5	7.5	7.5
Vehicle Extension (s)	3.0	3.0			3.0		3.0	3.0	3.0	3.0	3.0	3.0	3.0
Lane Grp Cap (vph)	103	257			280		663	2885	1290	590	2885	1290	1290
v/s Ratio Prot		0.02			c0.02			c0.19				0.16	
v/s Ratio Perm	0.01						0.15		0.01	0.01		0.01	0.01
v/c Ratio	0.07	0.26			0.29		0.19	0.24	0.02	0.01	0.20	0.01	0.01
Uniform Delay, d1	55.5	56.3			56.5		2.9	3.0	2.5	2.5	2.9	2.5	2.5
Progression Factor	1.00	1.00			1.00		3.34	3.62	6.79	0.65	0.60	1.00	1.00
Incremental Delay, d2	0.3	0.5			0.6		0.6	0.2	0.0	0.0	0.1	0.0	0.0
Delay (s)	55.8	56.9			57.0		10.2	11.2	16.8	1.6	1.9	2.5	2.5
Level of Service	E	E			E		B	B	B	A	A	A	A
Approach Delay (s)		56.8			57.0			11.2			1.9		
Approach LOS		E			E			B			A		

Intersection Summary

HCM 2000 Control Delay: 14.0, HCM 2000 Level of Service: B
 HCM 2000 Volume to Capacity ratio: 0.24
 Actuated Cycle Length (s): 130.0, Sum of lost time (s): 15.0
 Intersection Capacity Utilization: 66.6%, ICU Level of Service: C
 Analysis Period (min): 15
 c Critical Lane Group

HCM Unsignalized Intersection Capacity Analysis
10: Kennedy Road & L-3

BG 2041 PM

Movement	EBL	EBT	EBR	WBL	WBT	WBR	NBL	NBT	NBR	SBL	SBT	SBR	
Lane Configurations	↔	↔	↔	↔	↔	↔	↔	↔	↔	↔	↔	↔	
Traffic Volume (veh/h)	5	10	20	0	13	0	38	770	25	25	559	10	
Future Volume (Veh/h)	5	10	20	0	13	0	38	770	25	25	559	10	
Sign Control	Stop			Stop			Free			Free			
Grade	0%			0%			0%			0%			
Peak Hour Factor	0.92	0.92	0.92	0.92	0.92	0.92	0.92	0.92	0.92	0.92	0.92	0.92	
Hourly flow rate (vph)	5	11	22	0	14	0	41	837	27	27	608	11	
Pedestrians													
Lane Width (m)													
Walking Speed (m/s)													
Percent Blockage													
Right turn flare (veh)													
Median type	None						None						
Median storage (veh)													
Upstream signal (m)													
pX, platoon unblocked													
vC, conflicting volume	1170	1608	304	1304	1592	418	619						864
vC1, stage 1 conf vol													
vC2, stage 2 conf vol													
vCu, unblocked vol	1170	1608	304	1304	1592	418	619						864
tC, single (s)	7.5	6.5	6.9	7.5	6.5	6.9	4.1						4.1
tC, 2 stage (s)													
tF (s)	3.5	4.0	3.3	3.5	4.0	3.3	2.2						2.2
p0 queue free %	96	89	97	100	86	100	96						97
cM capacity (veh/h)	124	96	692	98	98	583	957						774
Direction, Lane #	EB 1	EB 2	WB 1	WB 2	NB 1	NB 2	NB 3	NB 4	SB 1	SB 2	SB 3	SB 4	
Volume Total	5	33	0	14	41	418	418	27	27	304	304	11	
Volume Left	5	0	0	0	41	0	0	0	27	0	0	0	
Volume Right	0	22	0	0	0	0	0	27	0	0	0	11	
cSH	124	225	1700	98	957	1700	1700	1700	774	1700	1700	1700	
Volume to Capacity	0.04	0.15	0.00	0.14	0.04	0.25	0.25	0.02	0.03	0.18	0.18	0.01	
Queue Length 95th (m)	0.9	3.8	0.0	3.6	1.0	0.0	0.0	0.0	0.8	0.0	0.0	0.0	
Control Delay (s)	35.1	23.7	0.0	47.7	8.9	0.0	0.0	0.0	9.8	0.0	0.0	0.0	
Lane LOS	E	C	A	E	A							A	
Approach Delay (s)	25.2		47.7		0.4							0.4	
Approach LOS	D		E										
Intersection Summary													
Average Delay			1.4										
Intersection Capacity Utilization			38.8%		ICU Level of Service							A	
Analysis Period (min)	15												

Timings
11: Kennedy Road & E-W3

BG 2041 PM

Lane Group	EBL	EBT	WBT	NBL	NBT	NBR	SBL	SBT	SBR	
Lane Configurations	↔	↔	↔	↔	↔	↔	↔	↔	↔	
Traffic Volume (vph)	4	28	44	123	829	25	5	567	7	
Future Volume (vph)	4	28	44	123	829	25	5	567	7	
Lane Group Flow (vph)	4	106	48	134	901	27	5	616	8	
Turn Type	Perm	NA	NA	Perm	NA	Perm	Perm	NA	Perm	
Protected Phases	4		8		2		6			
Permitted Phases	4				2		6		6	
Detector Phase	4	4	8	2	2	2	6	6	6	
Switch Phase										
Minimum Initial (s)	10.0	10.0	10.0	30.0	30.0	30.0	30.0	30.0	30.0	
Minimum Split (s)	33.5	33.5	33.5	37.5	37.5	37.5	37.5	37.5	37.5	
Total Split (s)	39.0	39.0	39.0	91.0	91.0	91.0	91.0	91.0	91.0	
Total Split (%)	30.0%	30.0%	30.0%	70.0%	70.0%	70.0%	70.0%	70.0%	70.0%	
Yellow Time (s)	5.0	5.0	5.0	5.0	5.0	5.0	5.0	5.0	5.0	
All-Red Time (s)	2.5	2.5	2.5	2.5	2.5	2.5	2.5	2.5	2.5	
Lost Time Adjust (s)	0.0	0.0	0.0	0.0	0.0	0.0	0.0	0.0	0.0	
Total Lost Time (s)	7.5	7.5	7.5	7.5	7.5	7.5	7.5	7.5	7.5	
Lead/Lag										
Lead-Lag Optimize?										
Recall Mode	None	None	None	C-Max	C-Max	C-Max	C-Max	C-Max	C-Max	
v/c Ratio	0.04	0.51	0.31	0.21	0.31	0.02	0.01	0.21	0.01	
Control Delay	54.8	28.8	61.4	1.2	0.7	0.0	4.0	8.3	1.4	
Queue Delay	0.0	0.0	0.0	0.0	0.0	0.0	0.0	0.0	0.0	
Total Delay	54.8	28.8	61.4	1.2	0.7	0.0	4.0	8.3	1.4	
Queue Length 50th (m)	1.0	7.4	11.9	0.6	2.3	0.0	0.4	49.7	0.0	
Queue Length 95th (m)	4.5	25.0	23.9	m2.4	6.2	m0.1	2.0	64.4	1.4	
Internal Link Dist (m)	142.7		136.9		395.2		561.7			
Turn Bay Length (m)	30.0			29.0		30.0		15.0		30.0
Base Capacity (vph)	331	464	456	633	2871	1292	470	2871	1292	
Starvation Cap Reductn	0	0	0	0	0	0	0	0	0	
Spillback Cap Reductn	0	0	0	0	0	0	0	0	0	
Storage Cap Reductn	0	0	0	0	0	0	0	0	0	
Reduced v/c Ratio	0.01	0.23	0.11	0.21	0.31	0.02	0.01	0.21	0.01	
Intersection Summary										
Cycle Length: 130										
Actuated Cycle Length: 130										
Offset: 0 (0%), Referenced to phase 2:NBTL and 6:SBTL, Start of Green										
Natural Cycle: 75										
Control Type: Actuated-Coordinated										
m Volume for 95th percentile queue is metered by upstream signal.										

Splits and Phases: 11: Kennedy Road & E-W3

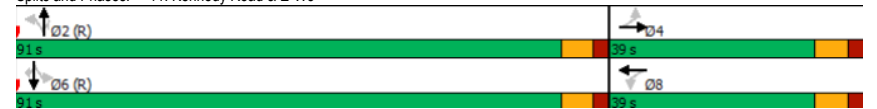

HCM Signalized Intersection Capacity Analysis

BG 2041 PM

11: Kennedy Road & E-W3



Movement	EBL	EBT	EBR	WBL	WBT	WBR	NBL	NBT	NBR	SBL	SBT	SBR
Lane Configurations	↔	↔		↔	↔		↔	↔	↔	↔	↔	↔
Traffic Volume (vph)	4	28	70	0	44	0	123	829	25	5	567	7
Future Volume (vph)	4	28	70	0	44	0	123	829	25	5	567	7
Ideal Flow (vphpl)	1900	1900	1900	1900	1900	1900	1900	1900	1900	1900	1900	1900
Total Lost time (s)	7.5	7.5		7.5	7.5		7.5	7.5	7.5	7.5	7.5	7.5
Lane Util. Factor	1.00	1.00		1.00	1.00		1.00	0.95	1.00	1.00	0.95	1.00
Frt	1.00	0.89		1.00	1.00		1.00	1.00	0.85	1.00	1.00	0.85
Fit Protected	0.95	1.00		1.00	0.95		1.00	1.00	0.95	1.00	1.00	1.00
Satd. Flow (prot)	1789	1681		1883	1789		3579	1601	1789	3579	1601	1601
Fit Permitted	0.73	1.00		1.00	0.42		1.00	1.00	0.31	1.00	1.00	1.00
Satd. Flow (perm)	1367	1681		1883	788		3579	1601	586	3579	1601	1601
Peak-hour factor, PHF	0.92	0.92	0.92	0.92	0.92	0.92	0.92	0.92	0.92	0.92	0.92	0.92
Adj. Flow (vph)	4	30	76	0	48	0	134	901	27	5	616	8
RTOR Reduction (vph)	0	70	0	0	0	0	0	0	5	0	0	2
Lane Group Flow (vph)	4	36	0	0	48	0	134	901	22	5	616	6
Turn Type	Perm	NA		Perm	NA		Perm	NA	Perm	Perm	NA	Perm
Protected Phases		4			8			2		2	6	
Permitted Phases	4			8			2		2	6		6
Actuated Green, G (s)	10.7	10.7		10.7	10.7		104.3	104.3	104.3	104.3	104.3	104.3
Effective Green, g (s)	10.7	10.7		10.7	10.7		104.3	104.3	104.3	104.3	104.3	104.3
Actuated g/C Ratio	0.08	0.08		0.08	0.08		0.80	0.80	0.80	0.80	0.80	0.80
Clearance Time (s)	7.5	7.5		7.5	7.5		7.5	7.5	7.5	7.5	7.5	7.5
Vehicle Extension (s)	3.0	3.0		3.0	3.0		3.0	3.0	3.0	3.0	3.0	3.0
Lane Grp Cap (vph)	112	138		154	632		2871	1284	470	2871	1284	1284
v/s Ratio Prot		0.02		c0.03			c0.25			0.17		0.17
v/s Ratio Perm	0.00						0.17		0.01	0.01		0.00
v/c Ratio	0.04	0.26		0.31	0.21		0.31	0.02	0.01	0.21		0.00
Uniform Delay, d1	54.9	56.0		56.2	3.1		3.4	2.6	2.6	3.1		2.6
Progression Factor	1.00	1.00		1.00	0.16		0.14	0.01	1.39	2.58		1.00
Incremental Delay, d2	0.1	1.0		1.2	0.6		0.2	0.0	0.0	0.2		0.0
Delay (s)	55.0	57.0		57.3	1.1		0.7	0.1	3.6	8.1		2.6
Level of Service	E	E		E	A		A	A	A	A		A
Approach Delay (s)		56.9		57.3			0.7			8.0		
Approach LOS		E		E			A			A		

Intersection Summary			
HCM 2000 Control Delay	8.0	HCM 2000 Level of Service	A
HCM 2000 Volume to Capacity ratio	0.31		
Actuated Cycle Length (s)	130.0	Sum of lost time (s)	15.0
Intersection Capacity Utilization	77.1%	ICU Level of Service	D
Analysis Period (min)	15		

c Critical Lane Group



BURNSIDE

[THE DIFFERENCE IS OUR PEOPLE]

Appendix C

Design Standards

ROADWAY ELEMENTS*	URBAN		RURAL	
	MIN	MAX	MIN	MAX
INSIDE TRAVEL LANE	3.3m	3.3m	3.5m	3.5m
OUTSIDE TRAVEL LANE**	3.5m	3.5m	3.5m	3.5m
RIGHT TURN LANE	3.5m	3.5m	3.5m	3.5m
LEFT TURN LANE	3.0m	3.3m	3.0m	3.3m
CONTINUOUS CENTRE TURN LANE	3.5m	5.0m	—	—
PAINTED CENTRE MEDIAN	—	—	1.2m	2.0m

* YR DESIGNING GREAT STREETS GUIDELINES (DGS)

** 4.25m – TRAVEL LANES FOR 2 LANE URBAN ROAD

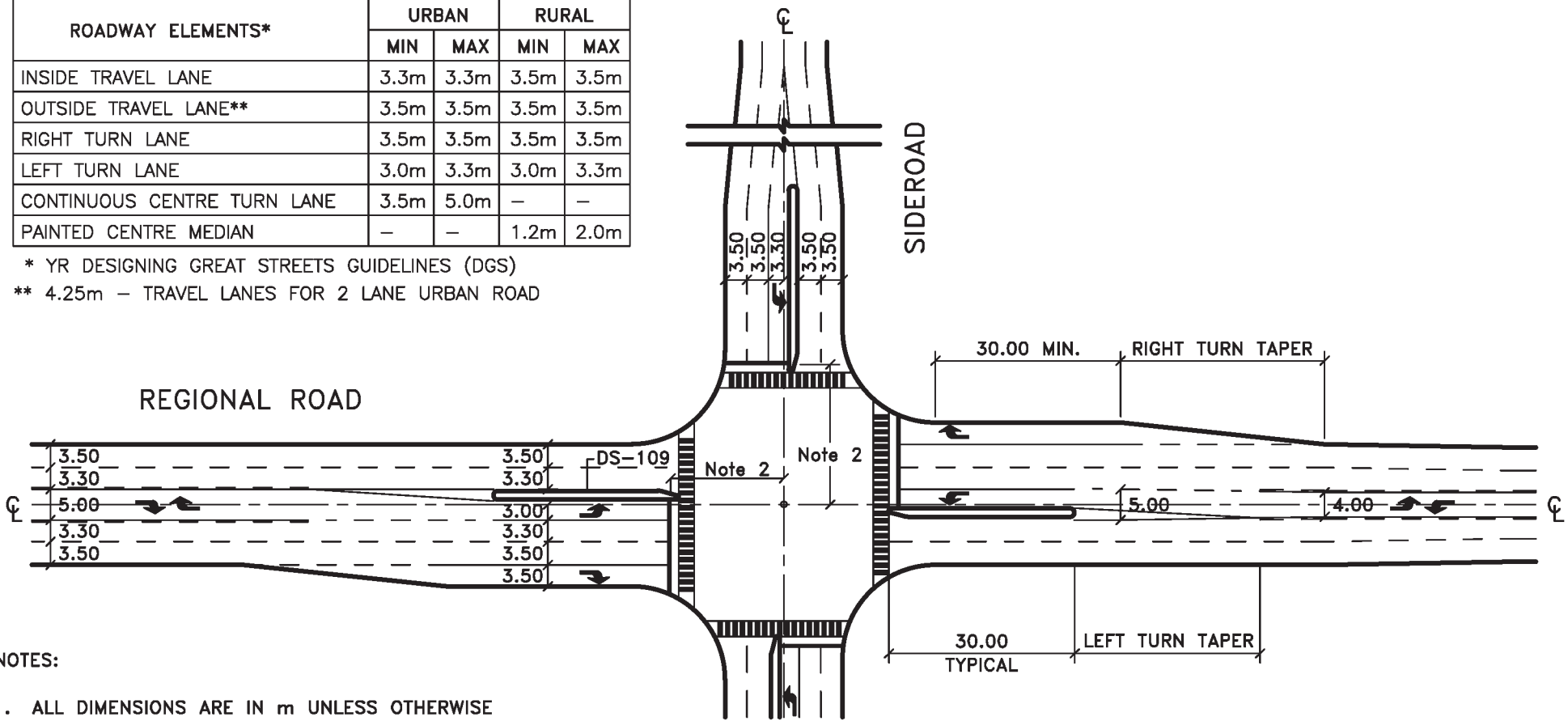

NOTES:

1. ALL DIMENSIONS ARE IN m UNLESS OTHERWISE NOTED.
2. OFFSET VARIES ACCORDING TO SIDEROAD WIDTH AND/OR ANGLE OF INTERSECTION.
3. MINIMUM 7.5m RADIUS. REFER TO DGS* FOR CURB RETURN CONSIDERATIONS. INCREASE RADIUS FOR INDUSTRIAL AREAS OR ROADS WITH HIGH VOLUMES OF RIGHT TURNING TRUCKS. USE TURNING TEMPLATES TO CONFIRM.
4. TURN TAPER RATIOS AND DECELERATION LENGTHS ARE BASED ON "TAC" MANUAL.
5. FOR HIGHER DESIGN SPEEDS, REFER TO "TAC" MANUAL CHAPTER 10.
6. STORAGE LENGTHS VARY WITH TRAFFIC VOLUMES.

POSTED SPEED (km/hr)	DESIGN SPEED (km/hr)	LEFT TURN TAPER RATIOS	RIGHT TURN TAPER RATIOS
50	50	8:1-30:1	11:1-17:1
60	60	15:1-36:1	14:1-17:1
70	80	15:1-48:1	17:1-24:1
80	90	27:1-54:1	Note 5



**4-LANE "X" INTERSECTION
(WITH MEDIAN ISLANDS)**

DATE: JANUARY 2023	SCALE N.T.S.
REV. X X	DS-105



BURNSIDE

[THE DIFFERENCE IS OUR PEOPLE]

Appendix D

Signal Warrant Analysis

Input Sheet

Main Road	Kennedy Road
Minor Road	EW-1
Direction of Main Road	North / South
Date:	6-Dec-22
No. of Lanes on Main	2 or more
T-Intersection	No
Operating Environment	Urban
Scenario	Forecasted Traffic Volumes (New Intersection)

Analysis Sheet

Justification 1: Minimum Vehicle Volumes

Justification	Guidance Approach Lanes				Total	Section Percent
	1 Lanes		2 or More Lanes			
Flow Condition	FREE FLOW	RESTR. FLOW	FREE FLOW	RESTR. FLOW		
1A (All Approach Lanes)	480	720	600	900	898	100%
				x		
	COMPLIANCE %					
1B (Minor Street Both Approaches)	120	170	120	170	144	85%
				x		
	COMPLIANCE %					
Signal Justification 1:						

Justification 2: Delay to Cross Traffic

Justification	Guidance Approach Lanes				Total	Section Percent
	1 lanes		2 or More lanes			
Flow Condition	FREE FLOW	RESTR. FLOW	FREE FLOW	RESTR. FLOW		
2A (Major Street Both Approaches)	480	720	600	900	755	84%
				x		
	COMPLIANCE %					
2B (Traffic Crossing Major Street)	50	75	50	75	55	73%
				x		
	COMPLIANCE %					
Signal Justification 2:						

Justification 3: Combination (Justification 1 and 2)

Justification Satisfied 80% or More	
Justification 1	Minimum Vehicular Volume
Justification 2	Delay Cross Traffic

Results Sheet

Justification	Compliance	Minimum Target	Signal Justified?	
			YES	NO
1. Minimum Vehicular Volume	A. Total Volume	100%	150%	NO
	B. Crossing Volume	85%		
2. Delay to Cross Traffic	A. Main Road	84%	150%	NO
	B. Crossing Road	73%		
3. Combination	A. Justification 1	85%	150%	NO
	B. Justification 2	73%		

Input Sheet

Main Road	Kennedy Road
Minor Road	EW3
Direction of Main Road	North / South
Date:	6-Dec-22
No. of Lanes on Main	2 or more
T-Intersection	No
Operating Environment	Urban
Scenario	Forecasted Traffic Volumes (New Intersection)

Analysis Sheet

Justification 1: Minimum Vehicle Volumes

Justification	Guidance Approach Lanes				Total	Section Percent
	1 Lanes		2 or More Lanes			
Flow Condition	FREE FLOW	RESTR. FLOW	FREE FLOW	RESTR. FLOW		
1A (All Approach Lanes)	480	720	600	900	965	107%
				x		
	COMPLIANCE %					
1B (Minor Street Both Approaches)	120	170	120	170	98	58%
				x		
	COMPLIANCE %					
Signal Justification 1:						

Justification 2: Delay to Cross Traffic

Justification	Guidance Approach Lanes				Total	Section Percent
	1 lanes		2 or More lanes			
Flow Condition	FREE FLOW	RESTR. FLOW	FREE FLOW	RESTR. FLOW		
2A (Major Street Both Approaches)	480	720	600	900	866	96%
				x		
	COMPLIANCE %					
2B (Traffic Crossing Major Street)	50	75	50	75	28	37%
				x		
	COMPLIANCE %					
Signal Justification 2:						

Justification 3: Combination (Justification 1 and 2)

Justification Satisfied 80% or More	
Justification 1	Minimum Vehicular Volume
Justification 2	Delay Cross Traffic

Results Sheet

Justification	Compliance	Minimum Target	Signal Justified?	
			YES	NO
1. Minimum Vehicular Volume	A. Total Volume	107%	150%	NO
	B. Crossing Volume	58%		
2. Delay to Cross Traffic	A. Main Road	96%	150%	NO
	B. Crossing Road	37%		
3. Combination	A. Justification 1	58%	150%	NO
	B. Justification 2	37%		

Input Sheet

Main Road	Kennedy Road
Minor Road	L3
Direction of Main Road	North / South
Date:	6-Dec-22
No. of Lanes on Main	2 or more
T-Intersection	No
Operating Environment	Urban
Scenario	Forecasted Traffic Volumes (New Intersection)

Analysis Sheet

Justification 1: Minimum Vehicle Volumes

Justification	Guidance Approach Lanes				Total	Section Percent
	1 Lanes		2 or More Lanes			
Flow Condition	FREE FLOW	RESTR. FLOW	FREE FLOW	RESTR. FLOW		
1A (All Approach Lanes)	480	720	600	900	849	94%
				x		
	COMPLIANCE %					
1B (Minor Street Both Approaches)	120	170	120	170	37	22%
				x		
	COMPLIANCE %					
Signal Justification 1:						

Justification 2: Delay to Cross Traffic

Justification	Guidance Approach Lanes				Total	Section Percent
	1 lanes		2 or More lanes			
Flow Condition	FREE FLOW	RESTR. FLOW	FREE FLOW	RESTR. FLOW		
2A (Major Street Both Approaches)	480	720	600	900	812	90%
				x		
	COMPLIANCE %					
2B (Traffic Crossing Major Street)	50	75	50	75	14	19%
				x		
	COMPLIANCE %					
Signal Justification 2:						

Justification 3: Combination (Justification 1 and 2)

Justification Satisfied 80% or More	
Justification 1	Minimum Vehicular Volume
Justification 2	Delay Cross Traffic

Results Sheet

	Justification	Compliance	Minimum Target	Signal Justified?	
				YES	NO
1. Minimum Vehicular Volume	A. Total Volume	94%	150%		NO
	B. Crossing Volume	22%			
2. Delay to Cross Traffic	A. Main Road	90%	150%		NO
	B. Crossing Road	19%			
3. Combination	A. Justificaton 1	22%	150%		NO
	B. Justification 2	19%			

Input Sheet

Main Road	Warden Avenue
Minor Road	EW-1
Direction of Main Road	North / South
Date:	6-Dec-22
No. of Lanes on Main	2 or more
T-Intersection	No
Operating Environment	Urban
Scenario	Forecasted Traffic Volumes (New Intersection)

Analysis Sheet

Justification 1: Minimum Vehicle Volumes

Justification	Guidance Approach Lanes				Total	Section Percent
	1 Lanes		2 or More Lanes			
Flow Condition	FREE FLOW	RESTR. FLOW	FREE FLOW	RESTR. FLOW		
1A (All Approach Lanes)	480	720	600	900	1,462	162%
				x		
	COMPLIANCE %					
1B (Minor Street Both Approaches)	120	170	120	170	397	234%
				x		
	COMPLIANCE %					
Signal Justification 1:						

Justification 2: Delay to Cross Traffic

Justification	Guidance Approach Lanes				Total	Section Percent
	1 lanes		2 or More lanes			
Flow Condition	FREE FLOW	RESTR. FLOW	FREE FLOW	RESTR. FLOW		
2A (Major Street Both Approaches)	480	720	600	900	1,065	118%
				x		
	COMPLIANCE %					
2B (Traffic Crossing Major Street)	50	75	50	75	178	237%
				x		
	COMPLIANCE %					
Signal Justification 2:						

Justification 3: Combination (Justification 1 and 2)

Justification Satisfied 80% or More	
Justification 1	Minimum Vehicular Volume
Justification 2	Delay Cross Traffic

Results Sheet

	Justification	Compliance	Minimum Target	Signal Justified?	
				YES	NO
1. Minimum Vehicular Volume	A. Total Volume	162%	150%	YES	
	B. Crossing Volume	234%			
2. Delay to Cross Traffic	A. Main Road	118%	150%		NO
	B. Crossing Road	237%			
3. Combination	A. Justification 1	162%	150%		NO
	B. Justification 2	118%			

Input Sheet

Main Road	Warden Avenue
Minor Road	EW-2
Direction of Main Road	North / South
Date:	6-Dec-22
No. of Lanes on Main	2 or more
T-Intersection	No
Operating Environment	Urban
Scenario	Forecasted Traffic Volumes (New Intersection)

Analysis Sheet

Justification 1: Minimum Vehicle Volumes

Justification	Guidance Approach Lanes				Total	Section Percent
	1 Lanes		2 or More Lanes			
Flow Condition	FREE FLOW	RESTR. FLOW	FREE FLOW	RESTR. FLOW		
1A (All Approach Lanes)	480	720	600	900	1,454	162%
				x		
	COMPLIANCE %					
1B (Minor Street Both Approaches)	120	170	120	170	174	102%
				x		
	COMPLIANCE %					
Signal Justification 1:						

Justification 2: Delay to Cross Traffic

Justification	Guidance Approach Lanes				Total	Section Percent
	1 lanes		2 or More lanes			
Flow Condition	FREE FLOW	RESTR. FLOW	FREE FLOW	RESTR. FLOW		
2A (Major Street Both Approaches)	480	720	600	900	1,280	142%
				x		
	COMPLIANCE %					
2B (Traffic Crossing Major Street)	50	75	50	75	86	115%
				x		
	COMPLIANCE %					
Signal Justification 2:						

Justification 3: Combination (Justification 1 and 2)

Justification Satisfied 80% or More	
Justification 1	Minimum Vehicular Volume
Justification 2	Delay Cross Traffic

Results Sheet

	Justification	Compliance	Minimum Target	Signal Justified?	
				YES	NO
1. Minimum Vehicular Volume	A. Total Volume	162%	150%		NO
	B. Crossing Volume	102%			
2. Delay to Cross Traffic	A. Main Road	142%	150%		NO
	B. Crossing Road	115%			
3. Combination	A. Justification 1	102%	150%		NO
	B. Justification 2	115%			

Input Sheet

Main Road	Warden Avenue
Minor Road	EW-3
Direction of Main Road	North / South
Date:	6-Dec-22
No. of Lanes on Main	2 or more
T-Intersection	No
Operating Environment	Urban
Scenario	Forecasted Traffic Volumes (New Intersection)

Analysis Sheet

Justification 1: Minimum Vehicle Volumes

Justification	Guidance Approach Lanes				Total	Section Percent
	1 Lanes		2 or More Lanes			
Flow Condition	FREE FLOW	RESTR. FLOW	FREE FLOW	RESTR. FLOW		
1A (All Approach Lanes)	480	720	600	900	1,761	196%
				x		
	COMPLIANCE %					
1B (Minor Street Both Approaches)	120	170	120	170	286	168%
				x		
	COMPLIANCE %					
Signal Justification 1:						

Justification 2: Delay to Cross Traffic

Justification	Guidance Approach Lanes				Total	Section Percent
	1 lanes		2 or More lanes			
Flow Condition	FREE FLOW	RESTR. FLOW	FREE FLOW	RESTR. FLOW		
2A (Major Street Both Approaches)	480	720	600	900	1,475	164%
				x		
	COMPLIANCE %					
2B (Traffic Crossing Major Street)	50	75	50	75	163	217%
				x		
	COMPLIANCE %					
Signal Justification 2:						

Justification 3: Combination (Justification 1 and 2)

Justification Satisfied 80% or More	
Justification 1	Minimum Vehicular Volume
Justification 2	Delay Cross Traffic

Results Sheet

Justification	Compliance	Minimum Target	Signal Justified?		
			YES	NO	
1. Minimum Vehicular Volume	A. Total Volume	196%	150%	YES	
	B. Crossing Volume	168%			
2. Delay to Cross Traffic	A. Main Road	164%	150%	YES	
	B. Crossing Road	217%			
3. Combination	A. Justification 1	168%	150%	YES	
	B. Justification 2	164%			

Input Sheet

Main Road	Warden Avenue
Minor Road	NS-2
Direction of Main Road	North / South
Date:	6-Dec-22
No. of Lanes on Main	2 or more
T-Intersection	No
Operating Environment	Urban
Scenario	Forecasted Traffic Volumes (New Intersection)

Analysis Sheet

Justification 1: Minimum Vehicle Volumes

Justification	Guidance Approach Lanes				Total	Section Percent
	1 Lanes		2 or More Lanes			
Flow Condition	FREE FLOW	RESTR. FLOW	FREE FLOW	RESTR. FLOW		
1A (All Approach Lanes)	480	720	600	900	1,535	171%
				x		
	COMPLIANCE %					
1B (Minor Street Both Approaches)	120	170	120	170	116	68%
				x		
	COMPLIANCE %					
Signal Justification 1:						

Justification 2: Delay to Cross Traffic

Justification	Guidance Approach Lanes				Total	Section Percent
	1 lanes		2 or More lanes			
Flow Condition	FREE FLOW	RESTR. FLOW	FREE FLOW	RESTR. FLOW		
2A (Major Street Both Approaches)	480	720	600	900	1,418	158%
				x		
	COMPLIANCE %					
2B (Traffic Crossing Major Street)	50	75	50	75	67	89%
				x		
	COMPLIANCE %					
Signal Justification 2:						

Justification 3: Combination (Justification 1 and 2)

Justification Satisfied 80% or More	
Justification 1	Minimum Vehicular Volume
Justification 2	Delay Cross Traffic

Results Sheet

	Justification	Compliance	Minimum Target	Signal Justified?	
				YES	NO
1. Minimum Vehicular Volume	A. Total Volume	171%	150%		NO
	B. Crossing Volume	68%			
2. Delay to Cross Traffic	A. Main Road	158%	150%		NO
	B. Crossing Road	89%			
3. Combination	A. Justification 1	68%	150%		NO
	B. Justification 2	89%			

