



INFLOW AND INFILTRATION REDUCTION STANDARD FOR SEWERS SERVICING NEW DEVELOPMENT

Version	Date	Description of Key Revisions
1	February 2022	Original version approved by York Regional Council
2	June 2022	Revised hydrostatic pressure threshold for high groundwater; allowed use of historical hydrogeological data where available; added Modified Reinforced Concrete Pipe to pipe material selection; revised timing of first CCTV inspection of mainline sewers; updated testing requirement for maintenance holes located in high ground water locations

NOTE:
This is a CONTROLLED Document. Any documents appearing in paper form are not controlled and should be checked against the on-line file version prior to use.
Notice: This Document hardcopy must be used for reference purpose only.
The on-line copy is the current version of the document.

TABLE OF CONTENTS

1	Introduction	1
2	Groundwater measurements	2
2.1	Single service retrofit connections to sanitary sewers	2
2.2	Subdivisions, site plans and industrial, commercial and institutional developments	2
3	Sanitary sewer pipe design	3
3.1	General.....	3
3.2	Pipe deflection and alignment.....	3
3.2.1	Polyvinyl chloride pipe	3
3.2.2	Reinforced Concrete Pipe (RCP) and Modified Reinforced Concrete Pipe (MRCP)	3
3.2.3	Concrete pressure pipe.....	4
3.2.4	High-density polyethylene pipe	4
3.2.5	Flexible sanitary sewer pipe.....	4
3.3	Minimum and maximum depths For direct connection to sanitary sewers	4
3.4	Service connection to regional sanitary sewers.....	5
3.5	Pipe bedding.....	5
3.6	Native soil and trench backfill.....	5
3.7	Trench plugs.....	6
4	Sanitary sewer maintenance hole design	7
4.1	General.....	7
4.2	Location	7
4.2.1	Access to maintenance holes	7
4.2.2	Site plans and Industrial, Commercial and Institutional (ICI) properties.....	7
4.3	Maximum spacing	8
4.4	Maintenance hole design	8
4.5	Maintenance hole connections.....	9
4.5.1	Flexible sewer pipe	9
4.5.2	Rigid sewer pipe	10
4.6	Maintenance hole adjustment and frame and covers	10
4.6.1	Maintenance hole adjustments	10
4.6.2	Frame and cover.....	11

4.7	Waterproofing	11
5	Sanitary sewer service connections design	12
5.1	General.....	12
5.2	Location	13
5.3	Size and configuration of service connections.....	13
5.4	Connection to mainline sanitary sewer.....	14
5.4.1	Abandoning service connections to flexible pipe mainline sewer.....	15
5.4.2	Abandoning service connections to rigid pipe mainline sewer	15
5.4.3	Reuse of existing connection at mainline sewer	15
5.5	Depth.....	15
5.6	Test fittings and cleanouts	16
5.7	Connections to site plans	16
5.8	Bedding and cover	17
6	Pipe and fitting materials	18
6.1	General.....	18
6.2	Gravity sanitary sewers.....	18
6.3	Sanitary service connections/lateral pipe	20
6.4	Fittings	20
6.4.1	Lateral to main fittings.....	20
6.4.2	Lateral risers	21
7	Inspection and testing	22
7.1	General.....	22
7.2	Closed circuit television	22
7.2.1	CCTV requirements for mainline sewers.....	23
7.2.2	CCTV requirements for service connections within the public right-of-way.....	23
7.2.3	CCTV requirements for private service connections.....	23
7.2.4	CCTV requirements for single dwelling retrofit connections	23
7.2.5	Video inspection equipment.....	23
7.2.6	Equipment specifications	24
7.2.7	Video camera transport equipment	24
7.2.8	Fog removal.....	24
7.2.9	TV operator training	24
7.2.10	Calibration of TV inspection counter	25

7.2.11	Calibration form	25
7.2.12	Timing of CCTV inspection and cleaning of sewer	25
7.2.13	Review and reporting of CCTV videos	26
7.3	Air testing mainline sewer and service connections	26
7.3.1	Determination of acceptance	27
7.3.2	Determination of failure	28
7.4	Mandrel testing for Flexible Pipe	28
7.5	Maintenance hole testing	29
7.5.1	General requirements	29
7.5.2	Testing for maintenance holes located in high groundwater locations	29
8	Optional flow and rainfall monitoring	32
8.1	General	32
8.2	Monitoring Plan Requirements	32
8.3	Peer Review Requirements	33
8.3.1	Peer Reviewer experience requirements	33
8.4	Monitoring Timing and Duration	34
8.5	Equipment and data collection	35
8.5.1	Rain gauges	35
8.5.2	Flow meters	35
8.5.3	Data collection and accuracy	36
8.6	Data Analysis	38
8.6.1	Base Infiltration (BI) and threshold values	38
8.6.2	Rainfall Derived Inflow and Infiltration (RDII) and threshold values	38
8.6.3	Data analysis methodology	38
8.7	Conformity report	39
8.7.1	Report structure	39
Glossary of terms		40

LIST OF TABLES

Table 1: Maximum maintenance hole spacing	8
Table 2: PVC pipe product and specifications	18
Table 3: Allowable pipe materials - depth of bury	19
Table 4: Allowable pipe materials - groundwater pressure	19
Table 5: Exfiltration test - low pressure air testing (OPSS.MUNI 410) (Flexible Pipe Materials)	27
Table 6: Deflection testing of flexible sewer pipes	29

LIST OF APPENDICES

- Appendix A: Illustration of Standard's applicability
- Appendix B: Design criteria decision flowcharts
- Appendix C: Recommended products and specifications
- Appendix D: Inspection and testing reports

LIST OF STANDARD DRAWINGS

- I&I – 101: “Sanitary sewer connections for residential developments (100mm, 125mm and 150mm dia. pipe)”
- I&I – 102: “Sanitary laterals in areas where the depth of the sewer main obvert exceeds 4.5m from the road centreline elevations”
- I&I – 103: “Sanitary service connections at the property line for single, semi residential dwelling and town home units (where permitted by the municipality)”
- I&I – 104: “Waterproofing membrane system for maintenance holes within areas susceptible to high groundwater or located within floodplains, areas of concentrated runoff”
- I&I – 105: “Sewer trench plug”
- I&I – 106A: “Sanitary sewer mainline to maintenance hole connection for flexible sewer pipe”
- I&I – 106B: “Sanitary sewer mainline to maintenance hole connection for rigid sewer pipe”
- I&I – 107A: “Maintenance hole drop structure type A”
- I&I – 107B: “Maintenance hole drop structure type B”
- I&I – 108: “Sanitary sewer pipe bedding and cover details”
- I&I – 109: “Sanitary maintenance hole internal drop structure”
- I&I – 110: “Air testing for private property component of sanitary service connections (single, semi residential dwelling and town home units)”
- I&I – 111: “Typical steel strap details for precast maintenance holes”

1 Introduction

The Inflow and Infiltration (I&I) Reduction Standard for Sewers Servicing New Development (the Standard) has been written for engineers, designers, constructors, inspectors and reviewers to use and reference when designing, reviewing, constructing, inspecting and performing quality control/assurance for new gravity sanitary sewer collection installations. This includes, but is not limited to, new subdivisions; site plans; industrial, commercial and institutional developments; and single service retrofit connections within the nine local municipalities of York Region (the Region).

This Standard has been developed in collaboration with York Region, its nine local municipalities and industry associations in an effort to reduce inflow and infiltration in gravity sanitary sewers and maximize the sanitary sewer system's service life and capacity. The intention of this document is to provide standardized specifications that will extend system life and performance as well as reduce extraneous inflow and infiltration in the sanitary sewer collection system within new developments throughout the nine local municipalities that make up York Region.

This document outlines the general procedures and minimum requirements for design, construction, testing and inspection of new gravity sanitary sewer collection systems (including, but not limited to, mainlines, maintenance holes and laterals/service connections on both the public and private right-of-way and specific features of sanitary sewer system construction that impact I&I reduction or elimination). It is intended to focus on watertightness and minimizing or eliminating I&I in new sanitary sewers **and shall be used in conjunction with all current local and regional design and construction standards¹ and specifications.**

Appendix A illustrates the applicability of the Standard.

This Standard contains:

1. Design and construction requirements
2. Inspection requirements for new local sanitary sewers and associated appurtenances
3. Testing requirements for new local sanitary sewers and associated appurtenances
4. Optional flow monitoring requirements

¹ Regional sanitary sewers shall be designed in conformance with the York Region Environmental Services Department Capital Planning and Delivery Branch Design Guidelines, Section 26 – Wastewater Systems

2 Groundwater measurements

2.1 SINGLE SERVICE RETROFIT CONNECTIONS TO SANITARY SEWERS

New gravity sanitary sewer collection installations for single service retrofit connections shall require a borehole and/or test pit to determine the groundwater level in lieu of piezometers. If an investigation is not performed or supporting record information is not available to determine the groundwater level, sewers shall be designed with the assumption that the hydrostatic pressure is greater than 103 kilopascals (kPa) (15 psi) or the pipe invert is 0.6 metres (m) below the Seasonal High Groundwater Table (SHGWT). Historical data and/or studies, completed within 10 years of submitting the development application, may be used to determine the groundwater level if a hydrogeological study cannot be performed, at the discretion of the municipality. Historical data shall be reviewed by a Professional Geoscientist or Professional Engineer licensed to practice in Ontario.

2.2 SUBDIVISIONS, SITE PLANS AND INDUSTRIAL, COMMERCIAL AND INSTITUTIONAL DEVELOPMENTS

New gravity sanitary sewer collection installations including, but not limited to, new subdivisions, site plans and industrial, commercial and institutional (ICI) developments within the nine local municipalities within York Region shall require a hydrogeological investigation and report, stamped by a Professional Geoscientist or Professional Engineer licensed to practice in Ontario.

The hydrogeological investigation shall utilize piezometers placed at regular intervals across the development site to document the anticipated hydrostatic pressures and SHGWT elevations. The Professional Geoscientist and or Professional Engineer shall determine the quantity, frequency and depth of the piezometers required to outline the anticipated hydrostatic pressures and SHGWT elevations along the length of the proposed sanitary sewers. Historical data and/or studies, completed within 10 years of submitting the development application, may be used to determine the groundwater level if a hydrogeological study cannot be performed, at the discretion of the municipality. Historical data shall be reviewed by a Professional Geoscientist or Professional Engineer licensed to practice in Ontario.

The hydrostatic pressures and SHGWT outlined within the report shall be used by the design engineer to select a suitable sanitary sewer pipe material as per the material selection flow charts included in Appendix B.

Where the hydrogeological study is not performed and/or historical record information is not available to determine the SHGWT level, all sanitary sewers and maintenance holes shall be designed following the assumption that they are installed 0.6m below the SHGWT and shall use the material, waterproofing and testing procedures outlined in this Standard. Maintenance holes shall be designed and installed as per Standard Drawing I&I – 104 – “Waterproofing membrane system for maintenance holes within areas susceptible to high groundwater or located within floodplains, areas of concentrated runoff.”

3 Sanitary sewer pipe design

3.1 GENERAL

All new sanitary sewers mainline, laterals/service connections shall be designed to be watertight and free from leakage. Details provided in the following sub-sections delineate specific features of sanitary sewer pipe design and materials that contribute to I&I reduction and ensure watertightness. The use of innovative designs and materials, not mentioned herein, may also be considered should their performance prove to be above and beyond requirements specified in this Standard and as agreed upon by the Region or local municipality. Additionally, designs shall look to reduce the number of pipe joints, maintenance holes and maintenance hole connections, where feasible, to minimize I&I in the system.

Where detrimental chemicals have been identified through the geotechnical investigation and environmental testing of soils, special consideration shall be given to ensure selected pipe and pipe gasket materials are compatible and resistant. The designer shall use all applicable manufacturers' recommendations for pipe and gasket materials to ensure chemical resistance of all gravity sewers and appurtenances.

3.2 PIPE DEFLECTION AND ALIGNMENT

In order to assure resistance to infiltration of ground water into sewer pipes, the deflection of any joints and/or pipe barrels shall not exceed that recommended by the pipe manufacturer. The requirements identified in sub-sections 3.2.1 through 3.2.5 are in addition to the requirements specified by manufacturers. Open cut applications shall avoid joint deflections, radius pipes and manufactured bends unless specifically approved by the design engineer and do not hamper future maintenance and inspection requirements. All pipe designs shall follow Section 6.

3.2.1 Polyvinyl chloride pipe

Polyvinyl chloride (PVC) pipe, for both pressure and non-pressure applications (refer to Section 6.2 for details), shall not exceed the maximum horizontal and vertical allowable deflection along the length of the pipe barrels as specified in the manufacturer's recommendations. Additionally, any joint deflection shall not exceed the recommendation of the pipe manufacturer. Pipe spigot ends shall be pushed into the bell ends up to the reference mark on the pipe. Field-cut pipe shall be square cut and the required pipe embedment length marked on the spigot end prior to assembly.

3.2.2 Reinforced Concrete Pipe (RCP) and Modified Reinforced Concrete Pipe (MRCP)

In situations where deflections have been either specifically approved or required to avoid unforeseen obstructions encountered during construction, the maximum opening of one side of the joint perimeter shall not exceed 13 millimetres (mm) beyond the normal assembled position, in accordance with Canadian Standards Association (CSA) A257.3 or the latest version thereof. Otherwise, gasketed pipe spigots shall be fully homed into pipe bells to ensure a watertight joint.

Reinforced concrete radial pipe shall not be used for sanitary sewers with diameters less than 1050mm. The minimum allowable radius for radial reinforced concrete pipe shall be 200m. Pipe spigots for radial pipe shall be fully homed into pipe bells. The designed horizontal alignment radius shall be achieved solely on the pipe barrel manufactured geometry.

Prefabricated tees, bends and other appurtenances shall be used when installing reinforced concrete pipe in new installations.

Modified RCP can also conform at AWWA C300, C301 or C302 without being classified as Concrete Pressure Pipe (CPP).

3.2.3 Concrete pressure pipe

Concrete pressure pipe (CPP) straight pipe joint deflection shall not exceed the manufacturer's recommendations. Manufactured horizontal bends to achieve radial segments in larger pipe diameters (greater than 600mm) shall generally not be permitted in order to minimize mainline sewer joints.

Prefabricated tees, bends and appurtenances shall be used when installing concrete pressure pipe in new installations.

3.2.4 High-density polyethylene pipe

High density polyethylene (HDPE) pipe shall have a minimum allowable horizontal alignment radius of 200m, in accordance with manufacturer's recommendations.

3.2.5 Flexible sanitary sewer pipe

For flexible pipe sanitary sewer installations greater than 4.0m in depth, the designer shall ensure the pipe class and pipe stiffness selected shall be sufficient to withstand to both live and dead loading without surpassing a maximum pipe deflection of 5%, as noted in the latest edition of the Handbook of PVC Pipe Design and Construction.

3.3 MINIMUM AND MAXIMUM DEPTHS FOR DIRECT CONNECTION TO SANITARY SEWERS

The maximum depth of sewers with direct lateral connections shall be 6.0m (measured from the finished centerline of road elevation to the obvert of the sewer). The minimum depth of sewers shall be 2.5m for residential and industrial areas and 3.65m for commercial areas.

In cases where deeper sewers (>6.0m) are required, these shall be considered as trunk sewers and no direct lateral /service connections will be permitted. Separate local sewers constructed above and adjacent to trunk sewers will be required for lateral/service connections. Local sewers will be connected to trunk sewers with drop structures where the junction of the two sewers exceeds 0.60m. External drop connections shall be used for connecting newly installed local sewers to newly installed trunk maintenance holes. Internal drop connections may be used for

connecting local sewers to existing trunk sewer maintenance holes where internal dimensions permit. External drop connections are preferred. Internal drop connections shall only be used where specifically approved by the local municipality. One internal drop connection will be permitted to a maintenance hole.

In cases where direct service connections to local trunk sanitary sewers are required, local municipal approval is required and the maximum depth permitted is 7.6m.

3.4 SERVICE CONNECTION TO REGIONAL SANITARY SEWERS

Sanitary service connections shall not be permitted to any regional sanitary sewers and trunk sewers. Any variance shall be at the sole discretion of the Region.

3.5 PIPE BEDDING

The pipe bedding type shall be selected to suit loading and subgrade soil conditions, ground water elevations and proposed pipe material type and shall be recommended by a geotechnical engineer, based on geotechnical report data. Details and types of bedding shall be in accordance with Standard Drawing I&I – 108 – “Sanitary sewer pipe bedding and cover details.” Alternate bedding materials may be approved based on the recommendations of a geotechnical engineer for site specific conditions.

Recommended granular pipe bedding materials:

- Granular ‘A’ conforming to OPSS.MUNI 1010
- 19mm Crusher Run Limestone conforming to OPSS.MUNI 1010 Granular ‘A’ Specification Table 2
- 19mm Type 2 Clear Limestone conforming to OPSS.MUNI 1004, 100% crushed (placed under Granular ‘A’ or 19mm Crusher Run Limestone for water bearing sand and silt)
- HL6 Limestone conforming to CSA S6 latest edition Table 7.9

All granular materials shall be compacted to a minimum 98% Standard Proctor Dry Density unless otherwise specified by a geotechnical engineer. In deeper applications greater than 4m, the designer shall ensure the backfill is sufficient for the pipe selection.

Pre-construction reports prepared by a geotechnical engineer shall include soil classification and recommendations for determining the structural requirements for the pipe and bedding and, where possible, construction methods to be used.

3.6 NATIVE SOIL AND TRENCH BACKFILL

Native soil may be used as trench backfill material from 0.3m above the top of the sanitary sewer pipe. If native soils are to be used, a geotechnical engineer is to provide recommendations for use of native backfill. Trench backfill type on public rights-of-way shall be per the municipality’s

requirements. For all requirements pertaining to bedding and cover refer to Standard Drawing I&I – 108 – “Sanitary sewer pipe bedding and cover details.”

3.7 TRENCH PLUGS

Where static ground water levels are greater than 1.0m above the average obvert elevation of the proposed sewer segment (i.e., distance between two sequential maintenance holes), trench plugs, comprised of a bentonite mixture or suitable native clays, shall be installed in the pipe bedding at intervals recommended by a geotechnical engineer and intervals shall not exceed 80.0m. Trench plugs shall be shown on the engineering drawings and be constructed in accordance with Standard Drawing I&I – 105 – “Sewer trench plug.” The material shall be reviewed and approved by a geotechnical engineer.

4 Sanitary sewer maintenance hole design

4.1 GENERAL

All newly constructed sanitary sewer maintenance holes shall be designed to be watertight and free from leakage. Details provided in the following sub-sections delineate specific features of sanitary sewer maintenance hole design and materials that contribute to I&I reduction and ensure watertightness. Maintenance hole design and construction shall follow standards and specifications outlined in the following sub-sections. The use of innovative designs and materials, not mentioned herein, may also be considered should their performance prove to be above and beyond requirements specified in this Standard and as agreed upon by the Region or local municipality.

4.2 LOCATION

Maintenance holes shall be located outside of floodplains. If it is not possible, the finished elevation (i.e., top of the frame and cover) shall be raised above the Regional 25-year storm elevation. Maintenance holes located within floodplains shall have waterproof bolt down covers installed per Section 4.6, be waterproofed per Section 4.7, and be tested per Section 7.

Maintenance holes requiring external vent structures shall have openings to the atmosphere at 1.5m above the Regional 25-year storm elevation.

Maintenance holes shall not be placed in areas where there will be concentrated surface runoff (i.e., near road curbs, water bodies, ditches, in low-lying areas or areas susceptible to water ponding). If it is not possible, maintenance holes shall have waterproof bolt down covers installed per Section 4.6, be waterproofed per Section 4.7, and be tested per Section 7.

4.2.1 Access to maintenance holes

Access for proper maintenance shall be provided to all maintenance holes installed in new developments. Areas surrounding maintenance holes shall allow for safe entry and sufficient space to accommodate all required safety equipment, as outlined in Section 4.6.

4.2.2 Site plans and Industrial, Commercial and Institutional (ICI) properties

Maintenance holes, where possible, shall be located outside of areas susceptible to surface ponding, parking lot storm water surface storage areas, high groundwater areas and hard surface areas. If not possible, all maintenance holes located in these areas shall have waterproof bolt down covers installed per Section 4.6, waterproofed per Section 4.7, and tested per Section 7. Additionally, all maintenance holes located on private property shall conform to the current Ontario Building Code.

4.3 MAXIMUM SPACING

Maximum recommended maintenance hole spacing is identified in **Table 1** and may be increased for a sanitary sewer segment in order to extend the location of a maintenance hole outside of a floodplain, without affecting operation and maintenance requirements. Increased maintenance hole spacing shall be approved by the local municipality on a case-by-case basis.

Table 1: Maximum maintenance hole spacing

For local collection sanitary sewer pipe sizes	
Sewer diameter (mm)	Maximum recommended spacing (m)
Up to and including 450	110
525 - 750	110 to 150
Greater than 750	150

For local trunk sanitary sewer pipe sizes	
Sewer diameter (mm)	Maximum recommended spacing (m)
Up to 1650	200
1650-1800	500
Greater than 1800	2000

4.4 MAINTENANCE HOLE DESIGN

Maintenance holes shall be constructed of precast concrete with a monolithic base conforming to CSA A257.4-M1982 or the latest version thereof. Maintenance hole design requirements shall follow specification and standards as outlined in Appendix B. In special applications where highly corrosive environments are anticipated, the designer may choose to use a polymer additive concrete maintenance hole product to combat the corrosive environment. In this case all other applicable design and construction standards (i.e., locations, waterproofing and connection details) shall continue to follow the standards as outlined in the section.

Cast-in place maintenance holes may be used at locations of sewer tie-in to an existing live sewer or when by-pass requirements are not practical. Alternately, “dog-house” maintenance holes and cast-in-place bases may be used at locations of sewer tie-in to an existing live sewer If the cast-in place maintenance hole installation is not practical. Rough-in benching shall be placed integral with the cast-in place base and the lower half of the sewer passing through the dog-house

maintenance hole shall be integral with the benching. Any annular space between sewer pipes and maintenance hole openings shall be mortared and parged with pre-packaged non-shrink grout prior to placing finished (second stage) benching. All pre-packaged non-shrink grout herein shall conform to American Society for Testing and Materials (ASTM) C1107.

Ontario Provincial Standard Specification (OPSS.MUNI 1351) and Ontario Provincial Standard Drawings (OPSD 701 Series) shall be used for maintenance hole design, where applicable. Maintenance holes shall be individually designed and detailed by the design engineer for trunk sewers within new developments or in all cases where Standard drawings are not applicable.

Maintenance holes shall be gasketed and shall be watertight to an internal hydrostatic pressure of 60 kPa (8.7psi). All maintenance hole joints shall be waterproofed with an external membrane as per section 4.7. Additional measures of maintenance hole performance and maintenance hole joint treatment and testing shall be specified, per the sub-sections below, to prevent water infiltration at locations of elevated ground water and higher hydrostatic pressures. A reference shall be made on all profile drawings to indicate the type and size of all sanitary maintenance holes.

Joints and gaskets for sanitary sewer drop structures used for maintenance holes shall conform to CSA B 182.1 and CSA B 182.2.

External drop structures shall be either precast concrete integral with the maintenance hole or field installed. Field installed external drop connections shall be completely encased in 20 megapascals (MPa) concrete in accordance with Standard Drawings I&I – 107A – “Maintenance hole drop structure type A” or I&I – 107B – “Maintenance hole drop structure type B.” For rigid pipe, the drop structure overflow pipe shall be completely encased in 300mm of 20 MPa concrete and shall extend to the first pipe joint beyond the drop structure. Internal drop structures shall be constructed in accordance with OPSD 1003.030.

Precast concrete maintenance holes located within floodplains shall have riser sections fastened to one another using steel straps in accordance with Standard Drawing I&I – 111 – “Typical steel strap details for precast maintenance holes.”

4.5 MAINTENANCE HOLE CONNECTIONS

4.5.1 Flexible sewer pipe

Flexible sewer pipe connections to new maintenance holes shall have factory installed resilient connectors (i.e., a flexible, watertight connector) in the structure opening in accordance with Standard Drawing I&I – 106A – “Sanitary sewer mainline to maintenance hole connection for flexible sewer pipe.”

Maintenance hole connectors shall conform to ASTM C923.

Flexible sewer pipe connections to existing maintenance holes shall be constructed using bell and spigot maintenance hole adaptors and resilient or elastomeric PVC waterstops conforming

to ASTM C923. Waterstops shall be installed at the mid-point of the maintenance hole wall and the annular space mortared and parged flush with the external and internal walls of the maintenance with pre-packaged non-shrink grout (as per ASTM C1107). A waterproofing membrane shall be installed at the connection of the pipe to the maintenance hole external wall. The waterproofing membrane shall extend 0.3m beyond the point of connection around the pipe and on the maintenance hole external wall.

4.5.2 Rigid sewer pipe

Rigid sewer pipe mainline connections to maintenance holes shall be made with a resilient connector for new installations where pipe sizes permit; otherwise, the annular space both inside and outside of the maintenance hole walls shall be mortared using pre-packaged non-shrink grout (as per ASTM C1107) or a core and seal boot. The first pipe entering and exiting the maintenance hole shall be completely encased in 300mm of 20 MPa concrete. After grout has sufficiently cured (prior to concrete encasing, where a resilient connector or waterstop has not been installed), the waterproofing membrane shall be installed at the connection of the pipe to the external wall of the maintenance hole. The waterproofing membrane shall extend 0.3m beyond the point of connection around the pipe and on the maintenance hole's external wall. Rigid Sewer pipe connections to maintenance holes shall be in accordance with Standard Drawing I&I – 106B - "Sanitary sewer mainline to maintenance hole connection for rigid sewer pipe."

4.6 MAINTENANCE HOLE ADJUSTMENT AND FRAME AND COVERS

4.6.1 Maintenance hole adjustments

The use of maintenance hole precast concrete adjustment units (Moduloc) is generally not permitted. Exceptions of up to two adjustment units may be allowed on a case-by-case basis subject to the approval of the municipality to facilitate adjusting frame and covers for final surface course asphalt placement only. Precast concrete adjustment units shall be mortared and parged using pre-packaged non-shrink grout (per to ASTM C1107). After grout has sufficiently cured, the precast concrete adjustment units must be fully wrapped with an approved waterproofing membrane. The waterproofing membrane shall extend over the top of the adjustment to form a gasket type seal on the underside of the frame.

Adjustment of maintenance hole frame and covers that cannot be facilitated by the above requirement shall be fabricated from precast concrete riser sections (minimum height of 300mm) or constructed of a minimum 30 MPa cast-in place concrete conforming to CSA A257.4-09 or current thereof and doweled to the precast concrete maintenance hole. Cast-in place and precast concrete adjustment sections must be fully wrapped with an approved waterproofing membrane after cast in place concrete has sufficiently cured and must extend to the underside of the frame.

Alternatively, products listed in Appendix C may be approved for use by local municipality and/or by "The Road Authority" in lieu of cast-in place adjustment sections. When the use of one of these alternative maintenance hole systems require the use of grade rings (i.e., Moduloc), they must be

mortared, parged and fully wrapped with an approved waterproofing membrane as previously outlined.

4.6.2 Frame and cover

Castings shall conform to CSA-B70.1-03, or latest version thereof and the municipality shall have the right to request mill test reports from the casting foundry.

Sanitary maintenance hole covers are to be of 'closed' type per OPSD 401.010, Type 'A' with a 2mm rubber gasket between the frame and cover except where specified otherwise and modified with a single lift hole in lieu of two lift holes, where available, to minimize infiltration into the maintenance hole.

Any maintenance hole that is located off the road allowance (in an easement, walkway, open space, etc.) shall be equipped with a security-type cover per OPSD 401.060, complete with the specified bolts and gaskets.

4.6.2.1 Frame and cover in floodplains

Maintenance holes located within floodplains, areas susceptible to vandalism, roadway pavements (where maintenance hole frame and covers are located within 1.0m from the face of curb), roadway low points susceptible to ponding, high groundwater areas, and/or areas of concentrated runoff, shall be equipped with watertight bolt down covers in accordance with OPSD 401.030. High groundwater is defined as hydrostatic pressures greater than 103kPa (15psi) and/or where the sewer invert is 0.6m or more below the Seasonal High Groundwater Table (SHGWT).

The maintenance hole frame and cover shall be a bolt down watertight type and the frame shall be secured to the maintenance hole risers to prevent displacement or shifting.

Elevated maintenance holes shall have a 1.0m-wide concrete apron around the periphery of the frame and cover to facilitate the installation of a tripod for safe operational access.

Where consecutive maintenance holes on trunk sewers are required to have watertight covers, extended vents shall be required at every third maintenance hole.

The elevation of the vents shall be above the 100-year flood elevation per the Conservation Authorities for the area. Vents shall have openings to the atmosphere at a minimum 1.5m above the finished grade or the 100-year flood elevation, whichever is greater. Venting details shall conform to York Region Standard Drawing 02.26 "Roof Mounted Ventilation Details" or York Region Standard Drawing 02.27 "Wall Mounted Ventilation Details".

4.7 WATERPROOFING

All lifting hooks that break through the surface into the precast maintenance hole sections shall be completely filled with 1:3 non shrink mortar mix.

All maintenance hole joints in new developments shall be waterproofed with a minimum 1.0m-wide membrane centred over the joint.

Maintenance holes located within a floodplain, areas of concentrated runoff, and/or areas with high groundwater, defined as hydrostatic pressures greater than 103kPa (15psi) and/or where the sewer invert is 0.6m or more below the SHGWT, and as outlined in Appendix B, are to be fully waterproofed in accordance with Standard Drawing I&I – 104 – “Waterproofing membrane system for maintenance holes within areas susceptible to high groundwater or located within floodplains, areas of concentrated runoff.” The entire external surface area of the maintenance hole including all walls, joints, adjustment sections and roof slab shall be wrapped in an approved waterproofing membrane. Each waterproofing membrane layer shall overlap a minimum of 0.15m.

All maintenance hole waterproofing shall be installed from the outside with membranes conforming to ASTM D412, D903, C836, E154, D1970, E96, D1876, D5385 & D570, or latest version thereof, or as recommended in Appendix C. Prior to installing membranes adhering surfaces shall be cleaned from debris/dirt and primed as per manufacturer’s recommendation for priming, if required. Adhering surfaces shall be free of dust, debris, and visible standing water. Primers shall be compatible with waterproofing membranes.

Membranes recommended for various installation temperatures and compatible primers are included in Appendix C. Membranes and the associated primer shall be applied in accordance with manufacturer specifications.

Protection board, asphaltic or polypropylene, shall be installed over the entirety of the waterproofing membrane to ensure integrity during the backfilling procedures.

Protection board shall be a material of sufficient strength to protect the membrane from damage caused by backfilling and compaction activities. Alternately, protection board may be substituted with a dimpled geocomposite drainage flexible board backfilled with a minimum 0.3m thickness of sand placed up against the dimpled geocomposite drainage sheet. A 0.3m layer of sand in lieu of protection board, as approved by the local municipality, may be installed around the entire waterproofing section to protect the waterproofing membrane.

5 Sanitary sewer service connections design

5.1 GENERAL

All newly-constructed sanitary sewer connections or lateral pipes shall be designed to be watertight and free from leakage. Details provided in the following sub-sections delineate specific features of sanitary sewer service connections and materials that contribute to I&I reduction and ensure watertightness. Sanitary sewer service connection design and construction to follow standards and specifications are outlined in the following sub-sections. The use of innovative designs and materials, not mentioned herein, may also be considered should their performance

prove to be above and beyond requirements specified in this Standard and as agreed upon by the Region or local municipality.

Sanitary sewer connections to municipal sewers for residential subdivision units shall be made with single² service pipes, shall conform to the following sub-sections and, where possible, also to the current Ontario provincial specifications.

Sanitary services shall be installed in accordance with Standard Drawings I&I – 101 – “Sanitary sewer connections for residential developments (100mm, 125mm and 150mm dia. pipe),” I&I – 102 – “Sanitary laterals in areas where the depth of sewer main obvert exceeds 4.5m from the road centreline elevations,” I&I – 103 – “Sanitary service connections at the property line for single, semi residential dwelling and town home units (where permitted by the municipality)” and the flow chart per Appendix B.

Any bends on sanitary service connections, where possible, shall be long radius, sweep bends.

The above-mentioned sanitary service for both the private lateral and the public right-of-way shall be infiltration/exfiltration tested, per Section 7, as a part of the mainline sewer.

5.2 LOCATION

The proposed locations for the sanitary sewer service connections shall be shown on the plan and profile drawings. Location shall be captured on all “As-Built” drawings.

The deflection of either joints and/or pipe barrels shall not exceed that recommended by the pipe manufacturer.

5.3 SIZE AND CONFIGURATION OF SERVICE CONNECTIONS

Service connections within public rights-of-way shall be 125mm diameter for each single dwelling unit and 150mm diameter for semi-detached units and each pair of townhouse units.

Service connections for single residential units shall be 125mm in diameter within the public right-of-way and shall have a 125mm x 100mm diameter reducer fitting at the property line. Beyond the reducer, on the private side of the property line, a 100mm diameter pipe shall extend a maximum of 1.5m beyond the property line and terminate with a watertight solvent-welded or gasketed cap.

Shared service connections within public rights-of-way shall be 150mm diameter from the sewer up to 1.0m from the property line. A 150mm x 150mm - 45° Wye fitting shall be installed centred 1.0m on the public side of the property line and a 150mm x 100mm reducer fitting shall be installed

² Semi-detached and two townhouse units may have a shared service connection within public rights-of-way, only if allowed by the local municipality

at the property line for each 150mm diameter branch. Beyond the reducer, on the private side of the property line, a 100mm diameter pipe for each dwelling unit shall extend a maximum of 1.5m beyond the property line and terminate with a solvent-welded or gasketed cap.

Adjacent units with greater than 0.2m basement elevation differences shall not be serviced by a shared service connection.

Building setbacks shall be used to guide the lateral/service connection extension distance beyond the property line onto private property for conditions where buildings are located in close proximity to the property line and do not allow the specified 1.5m extension.

The termination point of each service connection shall be marked with a 50mm x 100mm stake extending from the invert of the connection to a minimum 0.9m above the ground and shall be painted green and marked 'SAN'.

Service connections for multiple families and other blocks as well as commercial, institutional and industrial areas shall be sized individually, according to the intended use.

5.4 CONNECTION TO MAINLINE SANITARY SEWER

Service connections shall be made with factory manufactured tees for connections to new flexible pipe sewer mains. Watertight, resilient connectors, conforming to ASTM C-923 specifications, installed by the sewer pipe manufacturer shall be used for connections to new rigid pipe sewer mains.

Service connections to existing flexible pipe sewer mains shall be made by cutting out sections of sewer mains and installing factory manufactured tees, PVC mainline sewer filler piece(s) and PVC gasketed repair coupling(s) with no pipe stop.

Service connections to existing rigid pipe sewer mains shall be made by coring and installing a field installed watertight, resilient connector. Service connections with a diameter greater than half the diameter of an existing sewer main shall be made by cutting out sections of the sewer main and installing factory manufactured tees. Resilient couplings shall be installed on the outside of the pipe barrel to join the manufactured tee pipe segment to the existing sewer main. The field made joint to the mainline sewer shall be protected with 300mm of concrete and extend a minimum of 0.5m on either side of the couplings.

Service connections, 125mm or 150mm diameter, will be permitted to connect to a 200 mm or 250mm sanitary sewer with the installation of an approved manufactured tee (provided the invert of the service connection is above the spring line of the main sewer).

Connections to maintenance holes will only be permitted under the following conditions:

- At the intersection of a service connection which has a size greater than half the diameter of the main sewer
- At termination points including subdivision entrances and cul-de-sacs

A maximum of two (2) connections per maintenance hole will be permitted. Any connection directly to a maintenance hole must be pre-cored and shall be a manufacturer installed watertight, resilient connector.

Service connections to sanitary mains shall be installed per Standard Drawing I&I – 103 – “Sanitary service connections at the property line for single, semi residential dwelling and town home units (where permitted by the municipality).”

Abandoning of existing sanitary services shall be at the point of connection to the sewer main as indicated below.

5.4.1 Abandoning service connections to flexible pipe mainline sewer

Existing sanitary services connected with a factory tee fitting (excluding field installed saddles of any type) shall be abandoned with factory manufactured PVC plugs installed in the branch of tee fittings. Other types of sewer connections shall be abandoned by removing and replacing a segment of the flexible pipe mainline sewer or installing a segment of internal liner 0.5m to either side of the connection opening.

5.4.2 Abandoning service connections to rigid pipe mainline sewer

Existing sanitary services connected with a factory installed concrete tee, field installed saddle or resilient connector shall be abandoned with factory manufactured plugs. Waterproofing membrane shall be placed over the fitting and extend 0.5m beyond the connection opening on to the pipe. Waterproofing membrane shall be covered with a flexible protection board and padded with a minimum 0.3m thickness of sand or lean concrete. Alternately, a segment of internal liner shall be installed 0.5m to either side of the connection opening.

5.4.3 Reuse of existing connection at mainline sewer

The existing connection may be reused in cases where the connector/adaptor at the mainline sewer is determined to be watertight, the same size as the new service lateral and within one metre (1m) of the desired standard location. Waterproofing membrane shall be required extending 0.3m from the point of connection on the lateral pipe and 0.5m on to the mainline sewer pipe. Waterproofing membrane extending on to the mainline sewer pipe shall be covered with a flexible protection board and padded with a minimum 0.3m thickness of sand or lean concrete.

5.5 DEPTH

The depth of the service connections for typical low-rise units, (i.e., single family units and semi-detached and townhouse units) at the property line, measured from the final centreline road elevation to the obvert of the pipe, shall be:

- Minimum: 2.5m
- Maximum: 4.0m

The maximum depth of sewers with direct lateral connections shall be 6.0m (measured from the final road centreline elevation to the pipe obvert). In cases where deeper sewers are required, a separate trunk sewer with no direct laterals shall be considered.

Risers shall be used when one or both of the following scenarios apply:

- The depth to the obvert of the sewer main exceeds 4.5m from the final road centerline elevation
- The walls of the excavation are less than 30 degrees from the vertical centerline of the main sewer main

Controlled settlement joint fittings are to be used on all risers to reduce loading at the point of connection for laterals and sewer mains. Controlled settlement joints shall be constructed using either an injection molded or prefabricated fitting conforming with CSA B182.2, ASTM D3034 and F1336 or field made per Standard Drawing I&I – 102 – “Sanitary laterals in areas where the depth of the sewer main obvert exceeds 4.5m from the road centreline elevations.”

Risers shall be installed per Standard Drawings I&I – 101 “Sanitary sewer connections for residential developments (100mm, 125mm and 150mm dia. pipe)” and I&I - 102 “Sanitary laterals in areas where the depth of the sewer main obvert exceeds 4.5m from the road centreline elevations.” Service connections shall be installed per Standard drawing I&I – 103 – “Sanitary service connections at the property line for single, semi residential dwelling and town home units (where permitted by the municipality).”

5.6 TEST FITTINGS AND CLEANOUTS

Test fittings and vertical riser cleanouts shall not be used in the installation of lateral/service connections. These have been shown to be high-risk point sources of inflow and infiltration. Eliminating this as a source of inflow and infiltration is strongly recommended. Should test fittings or vertical risers be required, they shall be watertight and air pressure tested as per Section 7.3 of this document.

Service connections at the property line shall be installed per Standard Drawing I&I – 103 – “Sanitary service connections at the property line for single, semi- residential units and town home units (where permitted by municipality).”

5.7 CONNECTIONS TO SITE PLANS

An inspection maintenance hole shall be required on private property approximately 1.5m from the main property line (at the outlet of development) to the centre of the maintenance hole frame and cover. The outside wall of the maintenance hole shall not encroach on the public right-of-way.

5.8 BEDDING AND COVER

Bedding and cover for service connection laterals and risers shall conform to granular materials identified in Section 3.6 and Section 3.76. Bedding shall have a minimum thickness of 100mm and extended to undisturbed ground. The service connection shall be covered with a 300mm minimum thickness of granular material around the pipe. For riser sections, unshrinkable fill (i.e., concrete mix with less than 0.7 MPa compressive strength) may be used in lieu of granular material for bedding and cover. A Geotechnical Engineer shall confirm bedding and cover requirements.

6 Pipe and fitting materials

6.1 GENERAL

This section outlines the selection and use of pipe and fitting materials suitable for use on gravity sanitary sewer systems for projects with applications stated in Section 1.

6.2 GRAVITY SANITARY SEWERS

Sanitary sewer materials and classes shall be selected based on both hydrostatic requirements attributed to groundwater head pressure and structural capacity attributed to external loading (i.e., depth of bury).

Product materials for gravity sewers shall meet the minimum requirements set out in both **Table 3** and **Table 4**. The selection of a product material that meets the requirements of only one of the two tables will be deemed unacceptable. A design criteria decision flow chart has been included in Appendix B: Sanitary Sewer Pipe materials and Pipe Classification, that summarizes the two tables.

Sanitary sewers constructed of Polyvinyl Chloride (PVC) pipe shall conform to the specifications and pipe stiffness identified in **Table 2**. The maximum allowable internal pipe deflection for mainline sanitary sewer shall not exceed 5%. All PVC sanitary sewer pipe shall be green in color with the exception of PVC pipe conforming to IPS and CIOD (AWWA C900) standards which can be white. Should white PVC IPS or CIOD pipe be used for mainline sanitary sewer, a 1.0 -1.2m wide green mesh shall be installed 1.0m above the top of the sewer main laid along its length. Green mesh is only required for pipes not green in colour.

Table 2: PVC pipe product and specifications

Product	Specifications	Pipe stiffness
SDR 26 ¹	CSA B182.2, ASTM D3034/F679	800kPa
SDR 35	CSA B182.2, ASTM D3034/F679	320kPa
SDR 21	CSA B137.3, ASTM D2241	1540kPa
SDR 26 ²	CSA B137.3, ASTM D2241	800kPa
DR 18	CSA B137.3, ASTM D2241, AWWA C900	2500kPa
DR 25	CSA B137.3, ASTM D2241, AWWA C900	880kPa

Notes:

1. SDR 26 in sewer pipe dimension compatible to SDR outside diameters
2. SDR 26 in iron pipe size (IPS) are non-compatible with ASTM D3034/F679 pipe and fittings

Sanitary sewers constructed of reinforced concrete pipe (RCP) shall conform to CSA Specification A275-2-M1982 or latest revision thereof.

Sanitary sewers constructed of concrete pressure pipe (CPP) shall conform to AWWA C300, C301 or C302 or latest revisions thereof.

Sanitary sewers constructed of solid wall high density polyethylene (HDPE) shall conform to AWWA C901 and/or C906 or the latest versions thereof and ASTM F714 and/or D3034 or latest versions thereof. Pipe material specifications for all sanitary sewer pipe and the sewer bedding type shall be clearly indicated on all plan and profile drawings for each sewer length.

Table 3: Allowable pipe materials - depth of bury

Depth (m)	Pipe material**	Classification ^{1,2}
x* < 4	Polyvinyl chloride (PVC)	SDR-35, SDR-26, SDR-21, DR-25, DR-18
	Reinforced concrete pipe (RCP)	Class 50-D1, 65-D, 100-D, 140-D
	Concrete pressure pipe (CPP)	C300, C301, C302
	Modified RCP	65-D, 100-D, 140-D
	Solid wall high density polyethylene (HDPE)	SDR-11, SDR-9, SDR-7.3
4 < x* < 6	Polyvinyl chloride (PVC)	SDR-35, SDR-26, SDR-21, DR-25, DR-18
	Reinforced concrete pipe (RCP)	Class 65-D2, 100-D, 140-D
	Modified RCP	65-D, 100-D, 140-D
	Concrete Pressure Pipe (CPP)	C300, C301, C302
	Solid Wall High Density Polyethylene (HDPE)	SDR-11, SDR-9, SDR-7.3
x* > 6	Polyvinyl chloride (PVC)	SDR-26, SDR-21, DR-25, DR-18
	Reinforced concrete pipe (RCP)	Class 100-D, 140-D
	Concrete pressure pipe (CPP)	C300, C301, C302
	Modified RCP	65-D, 100-D, 140-D
	Solid wall high density polyethylene (HDPE)	SDR-11, SDR-9, SDR-7.3

Notes:

* Depth of sanitary sewer measured from finished road centre line/finished ground elevation to pipe obvert as per OPSD 807.010, 806.040 or current version thereof as guidelines.

** Products for trenchless applications (i.e., jack and bore, microtunneling, etc.) shall be confirmed by the design engineer and/or the manufacturer to meet the site specific geotechnical and hydrogeological conditions

¹ Verify maximum depth for pipe sizes and Class B bedding

² Pipe sizes 600mm diameter and larger require Class B bedding

Table 4: Allowable pipe materials - groundwater pressure

Groundwater head pressure (kPa)	Pipe material**
$y^* < 103$ (15psi)	Reinforced concrete pipe (RCP) and Modified RCP
	Polyvinyl chloride (PVC)
	Concrete pressure pipe (CPP)
	Solid wall high density polyethylene (HDPE)
$y > 103$ (15psi)	Polyvinyl chloride (PVC)
	Concrete pressure pipe (CPP)
	Modified RCP
	Solid wall high density polyethylene (HDPE)

Notes:

* Groundwater head pressure

** Products for trenchless applications (i.e., jack and bore, microtunneling etc.) shall be confirmed by the design engineer and/or the manufacturer to meet the site specific geotechnical and hydrogeological conditions

Pipe classification for depth of bury are based on the following or latest versions thereof:

- Reinforced concrete pipe and Modified RCP - OPSD 807.010, CSA A257 for applicable products
- Polyvinyl chloride gravity sewer pipe – OPSD 806.040
- Polyvinyl chloride pressure pipe – OPSD 806.060
- Concrete Pressure Pipe – AWWA C300, C301 and C302
- High density polyethylene - CSA B137.1, AWWA C901 and 906

Note: The OPSD reference burial depth is measured from the top of pipe whereas the Table 3 reference depth is measured from pipe obvert.

6.3 SANITARY SERVICE CONNECTIONS/LATERAL PIPE

All sanitary service connections for residential uses within public rights-of-way shall be constructed with PVC bell and spigot pipe with gasketed joints. The pipe materials shall be PVC SDR 28 pipe conforming to CSA B182.2 or the latest revision thereof. All PVC sanitary service pipe shall be green in color.

6.4 FITTINGS

6.4.1 Lateral to main fittings

PVC fittings shall have a minimum standard dimension ratio of 28 (SDR-28) or 35 (SDR -35). PVC fittings shall be manufactured in accordance with CSA B182.2, ASTM D3034 and F1336. Moulded fitting gaskets shall comply with ASTM F913 or F477. Moulded fittings shall be injection moulded from virgin PVC compound having a minimum cell classification of 12364 or 12454, in accordance

with and certified by NSF-14, to meet ASTM D1784. Moulded fittings shall be either green or white in colour and fabricated fittings shall be green in colour.

Reinforced concrete pipe fittings shall confirm to OPSS.MUNI 1820 and CSA A257.3.

6.4.2 Lateral risers

PVC pipe shall have a maximum standard dimension ratio of 28 (SDR-28) conforming to CSA B182.1 and/or B182.2 with gasketed joints.

PVC fittings shall be manufactured in accordance with CSA B182.2, ASTM D3034 and F1336. Moulded fitting gaskets shall comply with ASTM F913 or F477. Moulded fittings shall be injection moulded from virgin PVC compound having a minimum cell classification of 12454 in accordance with, and certified by NSF-14, to meet ASTM D1784. Moulded fittings shall be either green or white in colour.

Controlled settlement joints or approved equivalent shall be installed in close proximity of the service riser connection to the mainline sewer per Standard Drawing I&I – 102 – “Sanitary laterals in areas where the depth of the sewer main obvert exceeds 4.5m from the road centreline elevations.”

7 Inspection and testing

7.1 GENERAL

Testing and inspection are critical procedures for ensuring I&I reduction. This section outlines required inspection and testing procedures for mainline sewers, maintenance holes and service connections and the importance of tracking deficiencies through various testing methods. Upon completion of all performed tests, the developer's Qualified Representative, the local municipality and/or the local municipality's Qualified Representative shall create, review and maintain a list to track deficiencies and rectifications thereof to the requirements of the local municipality and/or this standard document. The developer's Qualified Representative, the local municipality's Qualified Representative and/or the local municipality shall witness all of the performed tests, approve the final reports and certify that all deficiencies have been rectified.

The aforementioned inspections and tests shall be applicable to all new gravity sanitary sewer collection installations.

7.2 CLOSED CIRCUIT TELEVISION

All closed-circuit television (CCTV) videos and reports shall clearly observe, identify and record structural and physical defects within the mainline sanitary sewer and the lateral service connection.

Prior to the commissioning of the mainline sewer, standard practice for equipment used for CCTV inspection and other specifications shall follow the OPSS.MUNI 409 (November 2017, or most recent version thereof). Observations and defect coding standards shall be in accordance with NASSCO 7.03 Edition, or most recent version thereof. No other CCTV inspection defect coding program shall be allowed.

CCTV inspections shall be performed to observe and record structural and service defects and construction features and to assess the thoroughness of cleaning. Defects shall be repaired in accordance with the local municipality's design criteria and this document.

Media storage recording shall be high-quality MPEG-2 or higher saved on a DVD or USB 2.0 or higher compatibility.

Each digital MPEG file and inspection report shall consist of only one pipe segment from maintenance hole to maintenance hole or node point (unless a reversal is required). In the event that a reversal is required, the inspection must be done immediately. A digital record of the CCTV inspection of the internal condition of the sewer pipeline shall be provided in addition to a printed and digital inspection report. Two (2) copies of the digital media (DVD or USB) shall be provided and three (3) copies of the printed report. (Reference OPSS.PROV 409.07.05.01 November 2017). This criterion may vary in accordance with municipalities' requirements.

The camera has to be positioned along the center axis of the sewer pipe to see the full periphery of the pipe. Lighting of the sewer must be sufficient to illuminate the camera view and be evenly distributed around the periphery of the pipe without loss of contrast. Extra lighting will be needed for large pipes. The camera must maintain a speed that will allow for the defects to be observed clearly. Start the video inspection in the centre of the upstream maintenance hole where you can visibly view the pipe entrance way. The camera must stop and pan/tilt toward the maintenance hole, pipe entrance, connections, junctions and major defects. When arriving at a connection/junction, the camera shall stop and pan/tilt toward the entrance, then the camera shall be directed to look directly into the connection/junction and note any defects. (Reference OPSS.PROV 409.07.04-01 November 2017) (Reference PSS.PROV409.07.04.02 November 017) (Reference NASSCO 7.03 edition or most current version thereof).

7.2.1 CCTV requirements for mainline sewers

All mainline sanitary sewers (i.e., both public and private right-of-way) are to be CCTV tested. CCTV testing shall be scheduled per Section 7.2.12.

7.2.2 CCTV requirements for service connections within the public right-of-way

All sanitary service connections within the public right-of-way shall be CCTV inspected after backfilling from the main to the termination point at or beyond the property line.

7.2.3 CCTV requirements for private service connections

A minimum of 25% of the sanitary sewer connections/laterals are to be inspected by CCTV camera from the service connection termination point beyond the property line to the building's interior cleanout at the time specified in Section 7.2.12. An additional 25% of the laterals/connections shall be CCTV tested if deficiencies in the original 25% sample show a failure rate of greater than or equal to 10%. This will continue until less than 10% failure is achieved within the 25% sample size or as specified otherwise by the municipality.

7.2.4 CCTV requirements for single dwelling retrofit connections

In the event that there is only one (1) service connection, the service connection shall be CCTV inspected. Mainline sewers located within the private right-of-way shall be CCTV inspected per Section 7.2.1.

7.2.5 Video inspection equipment

The video shall be of sufficient quality that all minor defects (hairline cracks, etc.) are clearly visible and the colour of the pipe inspected is true to actual conditions. Shall the video not be of this quality, as determined by the municipality or their Qualified Representative, the contractor shall be required to re-inspect the sewer line to produce an acceptable quality video at no additional cost. The picture quality on the monitor shall provide a minimum continuous 460 lines of resolution video picture. Linear measurement through pipes must be accurate to +/-0.5%.

7.2.6 Equipment specifications

- **Mainline camera equipment:** Minimum of 300m of mainline TV inspection cable, minimum of 470 H lines of resolution (for a sharp picture), minimum of 10X optical zoom and 4x digital zoom total 40.1 zoom capability for inspection and assessment, minimum of 360-degree rotation with optical viewing angle and minimum of 331-degree pan viewing angle range to view minute defects. The camera must have a manual override of the focus, iris and shutter, be flexible for special conditions, and have a self-levelling head.
- **Lateral launch equipment:** Must be able to pan/tilt and traverse multiple 45- and 90-degree bends and go up wyes. The inspection cable shall be at least 45m long. The launch camera must be able to launch with or against the flow into a minimum 100mm diameter connection/ junction. Mini TV inspection camera equipment must be able to pan/tilt or be a self-levelling camera to carry out the inspection of 100mm to 150mm diameter pipe. Each lateral camera must have a built-in sonde in the camera head for locating.

7.2.7 Video camera transport equipment

The camera shall be transported through the sewer by means of an all-wheel drive or tractor crawler. The tractor shall also be steerable and have adjustable camera lift for larger pipes. The transport unit must be capable of passing over minor surface imperfections, including, but not limited to, broken joints and solid debris up to 40mm in height.

Mounting of the camera on a float or skid unit for towing through the sewer shall only be permitted where the condition of the sewer precludes the use of a tractor and where authorized by the municipality or their Qualified Representative. If the camera is towed, the supporting equipment shall not impede the view of the camera and shall be stable to ensure steady and smooth progress through the sewer.

The camera transport unit shall permit a complete inspection of the sewer from the centre of the starting maintenance hole to the centre of the finishing maintenance hole. A remote reading counter shall be used to measure the distance travelled from the centre of the starting maintenance hole and the measurement shall be recorded in meters rounded to the nearest 0.1m.

7.2.8 Fog removal

The operator shall provide all necessary equipment to produce “fog free” conditions in the sewer. The Contractor shall ensure the camera lens is free from debris to ensure high picture quality. Videos with excessive fog will not be accepted and the sewer lines must be re-inspected.

7.2.9 TV operator training

The operator must have Pipeline Assessment Certification Program (PACP), Lateral Assessment Certification Program (LACP) and Maintenance Hole Assessment Program (MACP) training and shall re-test every three (3) years. The contractor’s in-house process and quality assurance person must also have completed the above courses. It is recommended that the municipality check the operator’s certification on the NASSCO website each year. Additionally, each municipality shall request a test video and report from each operator to be assessed for video

quality and to ensure adherence to defect codes of mainlines and laterals. This test video will be reviewed by a Qualified Representative of the municipality or a qualified third party. (Reference OPSS PROV 409.04.01 November 2017) (Reference OPSS PROV 409-08 November 2017) (Reference OPSS PROV 409.07.03 Coding Accuracy).

7.2.10 Calibration of TV inspection counter

Prior to the first camera inspection of the day, the camera shall be set up in the centre of an upstream maintenance hole and the meter counter shall be set to zero. The operator shall then press record on the camera and proceed forward with the camera (until the back end of the camera unit is in the pipe) and then reset the meter counter. **The operator must know the length of their camera and transport/crawler for the reset of their meter counter.** The operator shall then continue the TV inspection starting from the upstream maintenance hole and proceed to the centre of the downstream maintenance hole. The operator shall then record the metres of pipe inspected as measured by the CCTV equipment on a calibration form. Then, the operator shall do an accurate surface measurement from the upstream maintenance hole to the downstream maintenance hole. If the two measurements do not agree, the operator must recalibrate their CCTV equipment meter counter and redo the above steps until the two measurements agree.

7.2.11 Calibration form

A Calibration Form shall be created that must include the time, date, street name, municipality, contract number, upstream and downstream maintenance hole numbers, length of the inspected sewer section, surface measurement, drawing measurement, TV inspection truck number, operator name and helper name. This must be submitted each week at the request of the municipality.

7.2.12 Timing of CCTV inspection and cleaning of sewer

- All mainline sanitary sewers and laterals from the mainline sewer to the property line must be cleaned and CCTV inspected after the installation of base asphalt, where applicable. In situations of single dwelling retrofits, the lateral shall be cleaned and CCTV inspected after backfilling.
- All mainline sanitary sewers must be cleaned and CCTV inspected for a second time prior to the installation of top asphalt.
- In the event that air testing on the sanitary sewer system or any section thereof fails within an area of high groundwater (hydrostatic pressures greater than 103kPa (15psi) and/or where the sewer obvert is 0.6m below the Seasonal High Groundwater Table (SHGWT)), the Contractor shall perform an additional CCTV inspection during the seasonal high groundwater window (typically between April and May) to visually investigate potential leaks.
- All required sewer laterals/service connections within the private right-of-way are to be CCTV inspected, as specified in Section 7.2.3, immediately prior to occupancy permit and/or release of securities. The CCTV inspection shall be completed from the property line to the building face or the interior cleanout.
- All maintenance holes are to be inspected at the time of top asphalt installation via visual inspection or 3D maintenance hole wireless scanning equipment at the request of the municipality.

If the lateral is deemed dirty and the video inspection cannot be completed to the applicable standards, then the lateral must be flushed and cleaned prior to acceptance of the video inspection.

7.2.13 Review and reporting of CCTV videos

All CCTV videos shall be reviewed and commented on as outlined in the current NASSCO standard.

7.3 AIR TESTING MAINLINE SEWER AND SERVICE CONNECTIONS

All service connections and mainline sanitary sewers within the public right-of-way shall be air pressure tested, after backfilling and prior to base asphalt.

Air pressure testing shall also be performed for the private portion of each service connection, after backfilling, from the building face or inside cleanout to the termination of the public portion of the service connection in the vicinity of the property line, per Standard Drawing I&I – 110 – “Air testing for private property component of sanitary service connections (single, semi residential dwelling and town home units).” The plumbing contractor shall cut off the gasketed cap on the 100mm diameter service connection extending onto private property and install a 100mm diameter PVC wye complete with a watertight testing cap. An inflatable bladder shall be installed downstream of the sweeping tee and a watertight cap (i.e. solvent-welded or gasketed) shall be installed on the service connection in close proximity to the building foundation footing. All pipe and fitting materials used on the private side must comply with the Ontario Building Code requirements. Private lateral/service connection testing will be performed and documented as per the requirements of the building permit and, if required, be witnessed by the Municipality’s Building Inspector.

No final interconnection of the public and private portion of a service connection shall be made to a building(s) until passing air pressure testing results are determined satisfactory by the local municipality, the local municipality’s Qualified Representative and/or the developer’s Qualified Representative. The developer’s Qualified Representative should be a professional engineer licensed in the Province of Ontario and shall certify and stamp the test results.

In the event that the air pressure testing results are determined unsatisfactory by the local municipality, the local municipality’s Qualified Representative and/or the developer’s Qualified Representative, remedies shall be made to rectify the deficiencies until satisfactory air pressure test results are obtained. All deficiencies are to be rectified prior to occupancy permitted.

Standard practice for testing, equipment used and other specifications shall follow OPSS.MUNI 410, ASTM C924, ASTM F1417-11 and as noted herein. The Contractor is responsible for ensuring that the test is conducted in a safe manner and all applicable safety procedures are followed. Do not enter, or allow anyone to enter, the maintenance hole during testing. Low pressure air testing equipment shall include a pressure relief valve set to maximum 62 kPa (9.0psi) to avoid over pressurizing. Tests shall be conducted between two consecutive maintenance holes or to a stub end where the sewer does not terminate at a maintenance hole.

The test section shall be plugged at each end. The test section shall be filled slowly until a constant pressure of 24kPa (3.5psi) is maintained. If the groundwater level is above the sewer being tested, the air pressure shall be increased by 3.0kPa (0.45psi) for every 300mm of groundwater level above the pipe invert. If the groundwater table cannot be visually monitored in terms of the elevation from the pipe, the Municipality or their Qualified Representative may request that the groundwater level be measured prior to testing. The air pressure shall be stabilized for five (5) minutes and then regulated to maintain it at 20.5kPa (3.0psi) plus the allowance for groundwater, if any. After the stabilization period, the time taken for a pressure loss of 3.5kPa (0.50psi) shall be recorded. The time taken for a pressure drop of 3.5kPa (0.50psi) shall not be less than the times shown in **Table 5** (Column B) for lengths equal to or less than the length shown in **Table 5** (Column C).

Table 5: Exfiltration test - low pressure air testing (OPSS.MUNI 410) (for flexible pipe materials)

Column A	Column B	Column C	Column D
Normal pipe size (mm)	Minimum time (min:sec)	Length of pipe for minimum time (m)	Time per unit for longer lengths of pipe (sec/m)
100	1:53	182	0.623
150	2:50	121	1.140
200	3:47	91	2.493
250	4:43	73	3.893
300	5:40	61	5.606
375	7:05	48	8.761
450	8:30	41	12.615
525	9:55	35	17.171
600	11:20	30	22.425
675	12:45	27	28.382
750	14:10	24	30.040
825	15:35	22	42.397
900	17:00	20	50.450

Note: If the length of the test section is greater than the length shown in Column C, the testing time shall be the product of the length of test section multiplied by the value in Column D (i.e., minimum time = test length x Column D)

7.3.1 Determination of acceptance

If the time shown in **Table 5** for the designated pipe size and length elapses before the air pressure drops 3.5kPa (0.51psi), the section undergoing the test shall have passed and shall be presumed to be watertight. The test may be discontinued once the prescribed time has elapsed even though the drop of 3.5kPa (0.51psi) has not occurred.

7.3.2 Determination of failure

If the pressure drops 3.5kPa (0.51psi) before the appropriate time shown in **Table 5** has elapsed, the air loss shall be considered excessive and the section of pipe shall be determined to have failed the test.

In the event that air testing of the sanitary sewer system or any section thereof fails within an area of high groundwater (hydrostatic pressures greater than 103kPa (15psi) and/or where the sewer obvert is 0.6m below the SHGWT), the Contractor shall perform an additional CCTV inspection during the seasonal high groundwater window (typically between April and May) to visually investigate potential leaks. If site conditions limit the tests (e.g., restricted access in environmentally sensitive areas during spring time), an alternative test should be sought by the Contractor and approved by the local municipality.

In the event that air exfiltration testing on the sanitary sewer system or any section thereof fails and/or leak repair is unsuccessful, the use of other test methodology at the discretion of the Municipality or their Qualified Representative may be permitted. The Municipality or their Qualified Representative can also request air exfiltration testing again once the repair is complete. During retesting, maintenance holes shall be tested separately from sewer pipes.

7.4 MANDREL TESTING FOR FLEXIBLE PIPE

Standard practice for testing, equipment used and other specifications shall follow OPSS.MUNI 410. Mandrel deflection testing shall be performed on flexible pipe sewers. The mandrel deflection test shall be performed no sooner than thirty (30) days after final backfill to road subgrade elevation has been placed. For Site Plan applications the developer may request approval from the local municipality to perform mandrel testing prior to the 30 days previously noted. The mandrel shall be cylindrical in shape and constructed with an odd number of evenly-spaced arms or prongs, minimum nine (9) in number. The minimum diameter of the circle scribed around the outside of the mandrel arms shall be equal to the allowable deflected pipe diameter \pm 1mm. The contact length of the mandrel shall be measured between the points of contact on the mandrel arm or between sets of prongs. This length shall not be less than that shown in **Table 6**. The mandrel shall be checked with a go-no-go proving ring. The proving ring shall have a diameter equal to the allowable deflected pipe diameter \pm 0.1mm. An acceptable mandrel shall not pass through the proving ring. The proving ring shall be fabricated from steel a minimum of 6mm thick. For pipes 100mm to 750mm in diameter, the allowable deflected pipe diameter is 5.0% of the base inside diameter of the pipe. For pipes greater than 750mm in diameter, the allowable deflected pipe diameter is 5.0% of the base inside diameter of the pipe. The base inside diameter is defined in the CSA or ASTM standard to which the pipe is manufactured. Any section of pipe that does not allow the mandrel to pass shall be considered to have failed the deflection test. All sections of pipe that fail the deflection test shall be replaced and retested. Re-rounding is not accepted. Retesting shall be carried out no sooner than 30 days after backfill has been placed. Mandrel testing shall be witnessed and approved by the local municipality, the local municipality's Qualified Representative and/or the developer's Qualified Representative.

Table 6: Deflection testing of flexible sewer pipes

Nominal pipe size (mm)	Mandrel contact length (mm)
150	100
200	150
250	200
300	250
350	300
375	300
400	300
450	350
500	400
525	450
600	500
675	575
750	675
900	750
1050	900
1200	1050

7.5 MAINTENANCE HOLE TESTING

7.5.1 General requirements

Standard practice for testing, equipment used and other specifications shall follow OPSS 407 and ASTM C1244M or most recent version thereof.

Every maintenance hole shall be visually inspected. A photographic record and inspection with a condition rating shall be completed on every maintenance hole. The developer or their Qualified Representative shall complete and provide the inspection form in Appendix D.

Maintenance holes shall be inspected during all phases of construction by the developer or their Qualified Representative. Each maintenance hole shall be visually inspected for leakage after assembly and backfilling. Additionally, each maintenance hole shall be inspected and reported on as per Appendix D.

7.5.2 Testing for maintenance holes located in high groundwater locations

All maintenance holes located within areas of high groundwater (hydrostatic pressures greater than 103 kPa (15psi) and/or where the sewer invert is 0.6m below the Seasonal High Groundwater Table (SHGWT), per Appendix B) shall also be tested by either exfiltration, water testing or infiltration water testing prior to placement of asphalt. As an alternative, at the discretion of the local municipality or their Qualified Representative, additional testing may be performed by vacuum testing. Vacuum testing shall be conducted on un-backfilled maintenance holes in accordance with the standards noted in Section 7.5.2.3. Any maintenance hole with a chimney located in the SHGWT, as defined above, shall be chimney seal leakage tested as per Section 7.5.2.4.

7.5.2.1 Maintenance hole exfiltration water test

Prior to commencing testing, the contractor completing the test shall prepare and provide the testing methodology for review and acceptance by the local municipality, the local municipality's Qualified Representative and/or the developer's Qualified Representative.

Leakage shall not exceed a rate of three litres per hour (3L/hr) per metre of head above the lowest pipe invert in the maintenance hole.

Maintenance holes shall be repaired and re-tested, as required, until the test results are within the limits specified. Visible leaks shall be repaired regardless of the test results. The method of repair shall be per the approval of the local municipality or their Qualified Representative.

7.5.2.2 Maintenance hole infiltration water test

Prior to commencing the testing, the contractor completing the test shall prepare and provide the testing methodology for review and acceptance by the local municipality, the local municipality's Qualified Representative and/or the developer's Qualified Representative.

Standard practice for testing, equipment used, and other specifications shall follow OPSS 407 or ASTM C1244M. The test shall be conducted as an Infiltration Water Test.

7.5.2.3 Negative air (vacuum) test

Prior to commencing the testing, the contractor completing the test shall prepare and provide the testing methodology for review and acceptance by the local municipality, the local municipality's Qualified Representative and/or the developer's Qualified Representative.

All joints between the top of the frame and cover casting to the bottom of the maintenance hole base shall be included in the test, including but not limited to precast or cast-in-place maintenance hole sections, chimney sections and adjustment sections.

Equipment used shall be made specifically for vacuum testing maintenance holes.

A vacuum will be drawn and the vacuum drop over a specified time period shall be within the limits in the standard to determine the acceptability of the maintenance hole. The maintenance hole shall pass if the time for the vacuum reading to drop from 33.8kPa (4.9psi) of Hg to 30.4kPa (4.4psi) of Hg meets or exceeds the values in **Table 5** from ASTM 1244M.

If the maintenance hole fails the initial test, necessary repairs shall be made by an approved method. The maintenance hole shall then be retested until a satisfactory test is obtained. Visible leaks shall be repaired regardless of the test results.

7.5.2.4 Chimney seal leakage test

Prior to commencing the testing, the contractor completing the test shall prepare and provide the testing methodology for review and acceptance by the local municipality, the local municipality's Qualified Representative and/or the developer's Qualified Representative.

Install the chimney seal (an internal flexible rubber frame seal) and only the bottom expansion band in accordance with the manufacturer's recommendation. Fully tighten the bottom band. Do not install the top expansion band.

Pull the top of the seal away from the maintenance hole's frame and pour approximately four litres of water behind the seal. Observe the bottom seal for a minimum of one minute for leakage. No leakage shall be allowed.

If the bottom expansion band has any leakage during the test time, the chimney seal will have failed the test. The contractor shall be required to remove, replace or reposition the bottom expansion band and retest.

7.5.2.5 Determination of acceptance for maintenance hole testing

Each maintenance hole located in areas of high groundwater shall pass the applicable tests outlined in Sections 7.5.2.1-7.5.2.4 to be deemed acceptable for use. If a maintenance hole does not pass one or more of the tests, then that maintenance hole shall be deemed unacceptable and shall require all failed tests to be repeated until the maintenance hole is deemed acceptable.

The Contractor shall investigate the cause of failure and perform all required repairs and modifications to failed maintenance holes. Once all repairs and/or modifications are made, the maintenance hole shall be retested, as outlined in Section 7.5.2.1-7.5.2.4. The maintenance hole shall not be deemed acceptable for use until all tests are performed and all tests have passed.

8 Optional flow and rainfall monitoring

At this time, monitoring is an optional program to be considered at the discretion of the Region and/or the local municipality, especially in capacity constrained development areas. Monitoring can be used as a tool to quantify the success of the Standard. Unless otherwise indicated by the Region and/or the local municipality, prior to approval of the development, monitoring results will not be used for the evaluation of sewer performance. In selected areas, the Region will undertake a pilot program, up to 2024, to demonstrate the effectiveness of monitoring during the implementation phase of the Standard.

8.1 GENERAL

Upon substantial completion, the Owner/Applicant shall retain a Flow Monitoring Engineering Consultant and shall submit a Monitoring Plan to the requirements outlined in Section 8.2 below. The plan is to be reviewed and approved by the Region or local municipality prior to commencement of monitoring. Flow and rainfall monitoring shall start after at least 85% occupancy is achieved for the tributary catchment area or phase within the tributary catchment and shall continue for at least 12 consecutive months to capture one full hydrologic year, as per the requirements outlined in Section 8.4. Upon completion of work and the flow monitoring period, a Conformity Report, prepared by the Owner's/Applicant's Flow Monitoring Engineering Consultant, shall be submitted to a Peer Reviewer demonstrating how the requirements stipulated in Sections 8.5 and 8.6 have been met. The Conformity Report shall be prepared to the requirements outlined in Section 8.7 and shall be reviewed by the Peer Reviewer and stamped by a professional engineer as outlined in Section 8.3.

8.2 MONITORING PLAN REQUIREMENTS

A Monitoring Plan shall be submitted to the Region or local municipality upon substantial completion, consisting of the following at a minimum:

- Map showing location of flow meters and rain gauges and delineation of tributary catchment area
- Confirmation or proof from the local municipality demonstrating that 85% occupancy is achieved for a tributary catchment area
- Types of flow meters, sensors, rain gauges, primary devices and data loggers
- Type of data logging and analysis system
- Flow meter and rain gauge maintenance and calibration schedule
- Monitoring start dates and duration
- Data cleaning, QA/QC and reporting procedures
- Remedial contingency plan should the requirements not be met

The Monitoring Plan shall be prepared by a Flow Monitoring Engineering Consultant and reviewed and approved by the Peer Reviewer, selected and retained per the requirements outlined in Section 8.3, and submitted to the Region or local municipality at least thirty (30) days prior to the start of monitoring. The local municipality, the Region and/or the Peer Reviewer shall have the ability to request specific or additional information to be included in the Monitoring Plan, at their own discretion.

8.3 PEER REVIEW REQUIREMENTS

This section outlines the peer review requirements. The Peer Reviewer shall be retained by the Owner/Applicant once approved, in writing, by the local municipality and/or the Region. As part of the approval, the Owner/Applicant shall provide a list of at least three (3) Peer Reviewers qualified and available to do the work per the satisfaction of the Region or local municipality and as outlined in the following sections.

The Peer Reviewer shall review all submissions provided by the Owner/Applicant, including, but not limited to, a Monitoring Plan as outlined in Section 8.2, monthly data collection records and reports, monthly equipment maintenance and calibration reports, and a Final Conformity Report as outlined in Section 8.7, and shall ensure conformity to the requirements of this Standard. The Peer Reviewer shall then provide final correspondence, stamped by a Professional Engineer licenced in the province of Ontario, confirming that the information submitted meets and/or exceeds the requirements of this Standard.

8.3.1 Peer Reviewer experience requirements

The Peer Reviewer shall be one with demonstrated professional qualification and has no conflict of interest. At minimum, the following requirements shall be met:

- Professional Engineering certificate from the province of Ontario with minimum five (5) years of experience in flow and rainfall monitoring, wastewater and storm water analyses
- A minimum of five (5) years of experience with extraneous flow data collection and analysis
- No conflict of interest; Engineers/Consulting firms retained by the Owner/Applicant for the design and contract administration of the site and building servicing works and/or inspection, testing or monitoring are not qualified for peer review verification

The Peer Reviewer shall review all submissions provided by the Owner/Applicant and shall ensure conformity to the requirements of this Standard. The Peer Reviewer shall then provide final correspondence, stamped by a professional engineer licenced in the province of Ontario, confirming that the information submitted meets and/or exceeds the requirements of this Standard. The final approval shall be required prior to the release of all financial securities to the Owner/Applicant.

8.4 MONITORING TIMING AND DURATION

No monitoring shall start without an approved Monitoring Plan agreed to in writing by a local municipality representative or a York Region representative.

Flow and rainfall monitoring for new developments shall start no earlier than when a minimum of 85% occupancy is confirmed by the local municipality for the tributary catchment area. Monitoring shall continue for at least 12 consecutive months, contingent upon data quality as specified in Section 8.5.3, and shall consist of a minimum of one complete Spring and Summer season. For the purpose of inflow and infiltration monitoring, seasons are defined as Spring: from February 15 to May 14, Summer: from May 15 to October 31 and Winter: from November 1 to May 14 or when vegetation is dormant or active.

A minimum of sixteen (16) storm events that each generate a rainfall volume greater than or equal to 12.5mm shall be captured during the 12-month monitoring period. The sixteen storm events shall take place in the Winter and Summer periods, as defined above.

The monitoring period could be extended at the discretion of the Region or local municipality if the data is, in the opinion of the Region or local municipality, insufficient, inaccurate or incomplete.

All equipment, including rain gauges and flow meters, shall not be removed without written consent from the Region or the local municipality and as recommended by the Peer Reviewer. The Peer Reviewer shall provide confirmation that data collected meets the criteria as outlined in Section 8.5.3 prior to removing the meters and commencing the Conformity Report.

8.5 EQUIPMENT AND DATA COLLECTION

8.5.1 Rain gauges

General requirements for rain gauges used for monitoring shall be either a tipping bucket rain gauge or weighing rain gauge. The required levels of accuracy shall be within +/- 2% and equipped to work remotely with 4G wireless cellular technology or the newest technology available from cellular carrier networks providers within the province of Ontario at the time of installation.

8.5.1.1 Equipment

Rain gauges and electrical connections shall follow manufacturer's installation guidelines and procedures recommended for the type of gauge and shall meet the requirements of the applicable ASTM standard.

Heated rain gauges are strongly recommended. Rain gauges shall be installed and operated in both Summer and Winter seasons as defined in Section 8.4. The Monitoring Plan shall include frozen precipitation (flow data from hard freeze and snow melt can reveal the lowest and highest base infiltration conditions) that can be utilized in analyzing the data more effectively.

Tipping bucket rain gauges shall be field calibrated to provide assurance of a set volume to calibrate the bucket. Weighing rain gauges shall be calibrated using a calibration weight that conforms to ASTM Class 5, 6 or 7.

8.5.1.2 Placement and density

Rain gauges shall be placed on roof tops (where possible) within a 2 km radius of the monitoring area and shall be free from obstruction with maintenance access to rain gauges and shall have the ability to collect and transmit rainfall data for the entire duration of the monitoring period. There shall be at least two (2) rain gauges deployed for each development. One (1) additional rain gauge shall be deployed for each additional two (2) square kilometers (km²) in the development that exceeds four (4) km². Rain gauges shall be checked monthly at a minimum and shall be cleared of any obstruction during routine monthly inspections.

8.5.2 Flow meters

Flow meter sensors and primary devices shall follow the manufacturer's installation guidelines and procedures recommended for the type of meter, sensor and primary device and as described in this section below.

8.5.2.1 Equipment

The Flow Monitoring Engineering Consultant shall review the anticipated site conditions and anticipated extraneous flows and select an appropriate flow meter to suit the anticipated conditions. Equipment shall be chosen to ensure that the flow meter is operating accurately during both dry conditions/low flows and wet conditions/high or extraneous flows that may be present in the system. All meters and associated equipment must be CSA approved, meet all building code requirements and be equipped to work with 4G or the newest wireless cellular technology

available at the time of installation. All monitors shall be approved to operate in Zone 1 hazardous locations in accordance with the Canadian Electrical Code (CEC), Part 1, Section 18 and the National Electrical Manufacturers Association (NEMA) 6, Ingress Protection (IP) 67 or equivalent rating with an intrinsically safe (IS) certification. All sensors or combined sensors shall be rated for Class 1, Zone 1 hazardous locations compatible with the flow meter and shall meet IP68 or equivalent rating.

8.5.2.2 Primary devices

Flumes shall be considered for use in areas where flow levels expected are less than 15mm. All flumes shall meet ASTM D5390-93 and adhere to the conditions listed in Section 8.5.3. If non-standard primary flow devices are being used, data supporting the accuracy and precision of the methods being employed should be provided and approved by the Peer Reviewer and provided to the Region or local municipality for final approval.

8.5.2.3 Area Velocity (A/V) non-contact meters

Non-contact Area Velocity (A/V) meters shall be considered for use in areas where flow depths are greater than 15mm.

Many downstream target metering maintenance holes are also junction maintenance holes with larger lines. Backwater and surcharging in the larger line may render invalid data from flume devices installed on the incoming line. Non-contact A/V devices should be considered in these situations.

8.5.2.4 Flow meter placement

Meters should be placed on the incoming line in the most downstream maintenance hole that measures flow from the development, whereby at least 90% of new development flow within a tributary monitoring catchment is captured. Flow subtractions should not be used if the net (bracket) flow is less than 20% of the Gross (total) flow.

8.5.3 Data collection and accuracy

All flow meters and rain gauges shall be calibrated per manufacturer's specification. At a minimum, flow will be verified once per month through field measurements or a dye dilution test (per ISO 9555). Flow meter measurement shall be within no more than +/- 10% of the dye dilution flow rate or the field measurement. Other verification methods may be approved at the sole discretion of the Region or local municipality.

Flow and rainfall data shall be logged at a minimum 5-minute interval and the following must be achieved:

- a) A minimum of 95% raw data population for any consecutive 30-day period. Raw data is defined as data received directly from the meter and not subject to any data manipulation or automated fixing. For example: with a five-minute sample rate and a 30-day period there are a possible 8,640 samples. Of these a minimum of 8,208 (95%) must be recorded.

- b) A minimum of 90% good raw data for level and velocity channels for any consecutive 30-day period must be achieved. Good raw data is defined as sample points accurate to within the accuracy specified. For example: with a five-minute sample rate and a 30-day period there are a possible 8,640 samples. Of these a minimum of 8,208 (95%) must be provided to the local municipality or the Region and 90% or 7,387 of these must fall within the accuracy specifications.
- c) There must be a wireless connectivity ratio of at least 95% of the time for any consecutive thirty (30) day period. Additionally, meter uptime must be 95% of total of storms exceeding 12.5mm and no meter that qualifies for the 95% rule can be eliminated from the analysis within the report.
- d) A minimum of 90% good raw flow data shall be captured per individual rain event.

8.6 DATA ANALYSIS

8.6.1 Base Infiltration (BI) and threshold values

Base Infiltration shall be estimated as a daily volume based on a selection of at least three (3) consecutive dry days in each season as defined in Section 8.4.

Base Infiltration (BI), whether determined during the construction period or estimated from the average dry day flow diurnal curve after full occupancy, shall not exceed 1.8 litre/day/metre of public sewer (excluding building connections) and shall be calculated using the Stevens-Schutzbach Method or other approved equivalent empirical method.

8.6.2 Rainfall Derived Inflow and Infiltration (RDII) and threshold values

Rainfall Derived Inflow and Infiltration (RDII) compliance will be determined on a volumetric basis. The volume of RDII shall be determined for every storm event exceeding 12.5 mm during the 12 months of monitoring. Data shall be divided into Winter and Summer periods as described in Section 8.4 and RDII volume (Q) versus rainfall depth (i) plots shall be generated for each data set.

Meter subtraction for performance measurement shall not be allowed unless the net (bracket) flow is greater than 20% of the gross (total) flow.

8.6.3 Data analysis methodology

A Performance Test shall be used as follows:

- a) Rely on the depth of rainfall (mm) of each storm and not the intensity of rainfall (mm/hr)
- b) Determine the volume of inflow and infiltration entering the sewer during each storm
- c) Generate Q versus i plots in the forms of inflow and infiltration Volume to Rainfall Depth and inflow and infiltration Peak to Rainfall Depth

RDII equals measured flow minus Average Dry Day Flow (ADDF) for each corresponding clock-hour time step. The resulting RDII volume shall include both positive and negative readings to reduce the effect of 'noise' in the data.

Regression lines shall be generated through the Summer and Winter data sets and a 25-year, 4-hour 'design storm' (59.3 mm) shall be applied to the regression lines to determine the volume of RDII that is expected to be generated in the tributary monitoring area. The normalized maximum allowable RDII values shall not exceed, rainfall capture coefficient (C_v) of 0.5% in the Summer and C_v of 1.0% in the Winter, seasons as defined in Section 8.4.

8.7 CONFORMITY REPORT

8.7.1 Report structure

Upon completion of the work and flow monitoring period, the Owner/Applicant shall request approval from the Peer Reviewer prior to commencing the Conformity Report. A Conformity Report prepared by the Owner's Flow Monitoring Engineering Consultant shall be submitted to the Peer Reviewer demonstrating how the objectives have been met and RDII and GWI thresholds were not exceeded.

The following shall be submitted to the Town or the Region at a minimum:

- Electronic copy of the assembled Conformity Report and number of hard copies as required by the Region or local municipality and as outlined below
- Conformity Report to be reviewed and stamped and signed by a Professional Engineer/Peer Reviewer acknowledging that it has been reviewed and is satisfactory

The report shall include the following sections, at a minimum:

1. Overview of the subdivision
2. Equipment/technology selected
3. Locations of equipment
4. Duration of flow monitoring
5. Storm event summary
6. QA/QC procedures and monthly results (% good data)
7. Summary of results
 - a. Raw flow monitoring data, analyses methodology/calculations and tabulated results and the sanitary sewer model
 - b. RDII and GWI analysis
 - c. Summary of results (tables and figures) illustrating compliance with RDII and GWI thresholds

Glossary of terms

American Society for Testing Materials (ASTM): An international standards organization that develops and publishes voluntary consensus technical standards for a wide range of materials, products, systems, and services.

American Water Works Association (AWWA): An international non-profit, scientific and educational association founded to improve water quality and supply.

Applicant/Owner: Owner means the person/party who owns the land and the applicant is the party authorized by the Owner to assist in the administration of a specific construction contract or flow monitoring.

Backfill material: Fill material used above the embedment or cover material and below the lower of the subgrade or finished grade or the original ground.

Bedding material: Material placed in the bottom of the trench on which the pipe is laid.

Bell: The female end of a manufactured sewer pipe.

Benching: The smoothed cast in place concrete placed between the channel pipes and the chamber walls of a maintenance hole. Benching influences the hydraulic flow through the maintenance hole during sanitary sewer and drainage events.

Canadian Standards Association (CSA): A standards organization which develops standards in 57 different areas. CSA is a non-profit membership association serving industry, government, consumers and other interested parties in Canada and the global marketplace.

CCTV: Means closed-circuit television. An inspection method using a closed-circuit television camera system with appropriate transport and lighting mechanisms to view the interior surface of sewer pipes and structures.

Cleanout: Allows access to clean the sewer from the ground surface and flush out the main when it is clogged or backed up.

CIOD: Cast iron outside diameter (CIOD). The outside diameter of a pipe size remains constant whereas the inside diameter of a pipe size varies with wall thickness or pipe class.

Contractor: A properly licensed and experienced individual of a company that agrees to furnish labour, materials, equipment and associated services to perform the work as specified for a specified price.

Controlled settlement joint fitting: These fittings are slip joints, designed to accommodate movement due to ground settlement in a pipe/fitting “riser” connection.

Cover: Means the material placed from the top of the bedding to the bottom of the backfill for rigid pipe.

Deflection: Any change in the inside diameter of the pipe resulting from installation and imposed loads. Deflection may be either vertical or horizontal and is usually reported as a percentage of the base (un-deflected) inside pipe diameter.

DR: Dimension Ratio (DR), is the ratio of the pipe outside diameter to the pipe minimum wall thickness. As diameters change, the pressure rating remains the same for the same material, dimension ratio and application.

Dog house: The dog house is a specific type of maintenance hole in which the outside supporting wall is typically a precast structure that contains a reverse “U” shape cut out at the bottom of the wall.

Drop structure: Structure used to divert gravity flow when the inlet from one sewer and the outlet from another sewer are at elevations greater than 600mm in height. The drop structure can ensure a smooth transitional flow into the main sewer without creating nonuniform flow.

Exfiltration: Leakage or discharge of flows from sewer systems into the ground through leaks in pipes, joints, maintenance holes or other sewer system appurtenances.

Flexible pipe: Means pipe that can deflect 2% or more without cracking such as polyvinyl chloride, polyethylene, or steel pipe.

Flow Monitoring Engineering Consultant: One retained by the Owner/Applicant to prepare Monitoring Plan, carry out monitoring work and prepare the Final Conformity Report for review by the Peer Reviewer.

Floodplain: Floodplains are land areas adjacent to rivers and streams that are subject to recurring inundation. Owing to their continually changing nature, floodplains and other flood-prone areas need to be examined to determine any potential affects regarding the current and future development.

Frame and cover: A removable plate forming the lid that rests over top of the opening of a maintenance hole. It is designed to prevent anyone or from falling in, and to ensure access is provided for authorized personnel who are qualified to enter the maintenance hole.

Groundwater level (table): Upper surface of the zone of saturation in permeable rock or soil.

Groundwater: All water under the surface of the ground whether in liquid or solid state. It originates from rainfall or snowmelt that penetrates the layer of soil just below the surface.

Head: Also referred to as hydraulic head, fluid mechanical energy per unit weight of fluid, which correlates to the elevation that water will rise to, also hydraulic head.

Hydrostatic pressure: The pressure equal to that which is (or would be) induced by the weight of the overlying column of water, the height of water above the point in question.

Iron pipe size (IPS): Piping made to the outside diameter (OD) of wrought iron or carbon steel pipe. The outside diameter of a pipe size remains constant whereas the inside diameter of a pipe size varies with wall thickness or pipe class.

Infiltration: The water entering a sewer system, including building sewers, from the ground through such means as defective pipes, pipe joints, connections or maintenance hole walls. Flow deriving from groundwater tends to be continuous and dependent on groundwater levels. Infiltration can vary depending on seasonal changes as the groundwater table also varies. Infiltration does not include inflow.

Inflow: Water other than wastewater that enters a wastewater system and building sewer from sources such as roof leaders, cellar drains, yard drains, area drains, foundation drains, drains from springs and swampy areas, maintenance hole covers, cross connections between storm drains and sanitary sewers, catch basins, cooling towers, stormwater, surface runoff, street wash waters, or drainage.

Inspection: The act of inspecting. An official examination or review of the work completed or in progress to determine its compliance with contract requirements.

Invert: The lowest point of the internal cross section of a pipe or sewer.

Joint: The location at which two pieces of pipe or a pipe and a fitting are connected. The joint may be made by a mechanical device, such as threads or ring seals, by heat fusion and cementing, or by finished ends made to fit together (bell and spigot).

Lateral: See Service Connection.

Maintenance hole: A sewer access large enough for a person to enter to trouble-shoot service problems or perform maintenance work.

Maintenance hole riser sections: Circular or rectangular, vertical segment(s) of a maintenance hole structure that extend from the base to the maintenance hole chimney

Mandrel: A rigid device -spindle or an axle – pulled through flexible thermo-plastic pipe to test alignment and deflection.

Municipality: The Corporation of a municipal district being either The Regional Municipality of York or one of the nine local municipalities. The Corporation that the Provincial Government, through an act of the legislature, has granted decision-making power over a part of the province.

Kor-N-Tee: A sewer industry recognized watertight, resilient type adapter to facilitate small diameter branch connections to rigid mainline sewer pipe or maintenance holes. The outside diameter at one end of the adapter is closely matched to the opening diameter in the mainline sewer pipe. The upper portion of the adapter has a larger outside diameter that seats on the outside of the sewer pipe preventing the adapter from protruding beyond the inside wall of the pipe at the connection opening. The inside diameter of the upper portion of the adapter is of slightly larger diameter than the branch pipe and the geometry of the adapter prevents over insertion. Watertightness is achieved with an external compression clamp and internal expansion ring.

Obvert: The highest point of the internal cross section of a pipe or sewer.

Operator: The party that has operational control over construction plans and specifications, including the ability to make modifications to those plans and specifications.

OPSD: Ontario Provincial Standard Drawing (OPSD) is a set of standard drawings defined by the province of Ontario that engineers and contractors must abide to. These standard drawings are engineering design drawings for roads and public works.

OPSS.MUNI: Ontario Provincial Standard Specification (Municipal) are specific standards created by each municipality. The OPSS is adjusted to ensure that the standards apply to the municipality.

OPSS.PROV: Ontario Provincial Standard Specification (Provincial) are specific standards created by each province. The OPSS is adjusted to ensure that the standards apply to each province.

OPSS: Ontario Provincial Standard Specification (OPSS) is a set of standards defined by the province of Ontario that engineers and contractors must abide to. These standards are engineering design standards for roads and public works.

Qualified representative: One hired by the owner or client to give professional advice and may be a consultant hired by the Municipality or developer. A qualified individual authorized by the owner to assist in the administration of a specific construction contract.

Right-of-way: The width of the total land that is under the authority of a public agency for the construction and limitation of the roadway.

Right- of-way (private): Refers to a parcel of land owned by a property owner.

Right-of- way (public): Refers to a parcel of public agency (municipal, provincial or federal) owned land which includes the roadway, sidewalks and any utility infrastructure within the City-owned land (e.g., electrical equipment, water mains, gas lines and telecommunication cables).

Rigid pipe: Means pipe that cannot deflect more than 2% without cracking such as concrete pipe. Rigid pipe is usually made of plain concrete, reinforced concrete, vitrified clay, cast iron and asbestos cement. Rigid pipes have sufficient strength to support loads even if no side support, such as backfill, is provided.

Resilient connector: A flexible connector which joins pipe to another pipe that can be deformed and deflected without leakage or rupture.

Peer Reviewer: One retained by Owner/Applicant to review all submissions provided by the Owner/Applicant, including but not limited to, Monitoring Plan, monthly data collection records and reports, and Final conformity report, and shall ensure conformity to flow monitoring requirements.

Pipe classification: A pipe's physical material specification, such as load and pressure ratings, wall thickness, protective coatings, corrugation profiles, ring stiffness constants, and reinforcement.

Prepackaged non-shrink grout: A factory manufactured, positive expansive, Cementous mixture containing only natural aggregate and an expansive cementitious binder.

Protection board: A mat that is typically placed over waterproofing membrane to protect from damage that has the compressive strength and impact resistance to withstand high load pressures. The board is typically made of durable extruded polystyrene *mat* or a multi-ply, semi-rigid core composed of a mineral-fortified asphalt core formed between two outside layers of asphalt-impregnated reinforced mats.

Sanitary sewer: A sewer receiving and carrying liquid and water-carried wastes under gravity flow, to which storm, surface, or groundwater are not intentionally admitted.

Sanitary sewer collection system: A sanitary sewer collection system collects local sanitary sewage and conveys sanitary sewage. The sanitary sewer collection system consists of but not limited to, sanitary sewer pipes, sanitary maintenance holes and individual sanitary connections servicing single and multiple building units located under both public and private roads allowances and common element areas, including the segment of service connections external to building units on private property.

Seasonal high groundwater table: Seasonal high groundwater table (SHGWT) is the elevation to which ground or can be expected to rise due to a normal wet season.

Service connection: Means the pipe used to convey sanitary sewage from the property line to the main sanitary pipe sewer, respectively.

Specifications: A detailed, exact statement of particulars, especially statements prescribing materials and methods; and quality of work for a specific project.

Spigot: The male end of a sewer pipe.

Standard: The prescribed, concise set of conditions and requirements that must be satisfied by a material, product, process, procedure, convention, or test method; and the physical, functional, performance and/or conformance characteristics thereof.

Standard dimension ratio: Standard dimension ratio (SDR) is a method of rating a pipe's durability against pressure. The standard dimension ratio describes the correlation between the pipe dimension and the thickness of the pipe wall.

Thermo-plastic: A plastic that repeatedly can be softened by heating and hardened by cooling through a temperature range characteristic of the plastic, and that in the softened state can be shaped by flow into articles by molding or extrusion. Thermo-plastic pipe is available in a variety of plastic compositions including the most common in sewer systems being Polyvinyl chloride (PVC), Polyethylene (PE), and Acrylonitrile-butadiene-styrene (ABS).

Trench plug: Barriers that help to slow the lateral seepage of water through sewer trench backfill, cover and bedding materials.

Trunk sewer: A sanitary sewer line that receives wastewater flow from the collector sewer and conveys this wastewater to an intercepting sanitary sewer. Little to no service connections are permitted.

Waterstop: A gasket made of resilient material that is placed on the exterior circumference of an appurtenance that extends through a concrete structure and is typically installed within the structure wall(s) as a barrier for water seepage.

Waterproofing membrane: A waterproofing membrane is a thin layer of material used to prevent water transmission through a medium or from contacting another material that it is placed over. Waterproofing membranes may be adhesive or simply laid on top of the material they are supposed to protect.

Water-tight: Put together in such a way that no water can get in or through-except in quantities allowed by the performance test.

APPENDIX A: ILLUSTRATION OF STANDARD'S APPLICABILITY

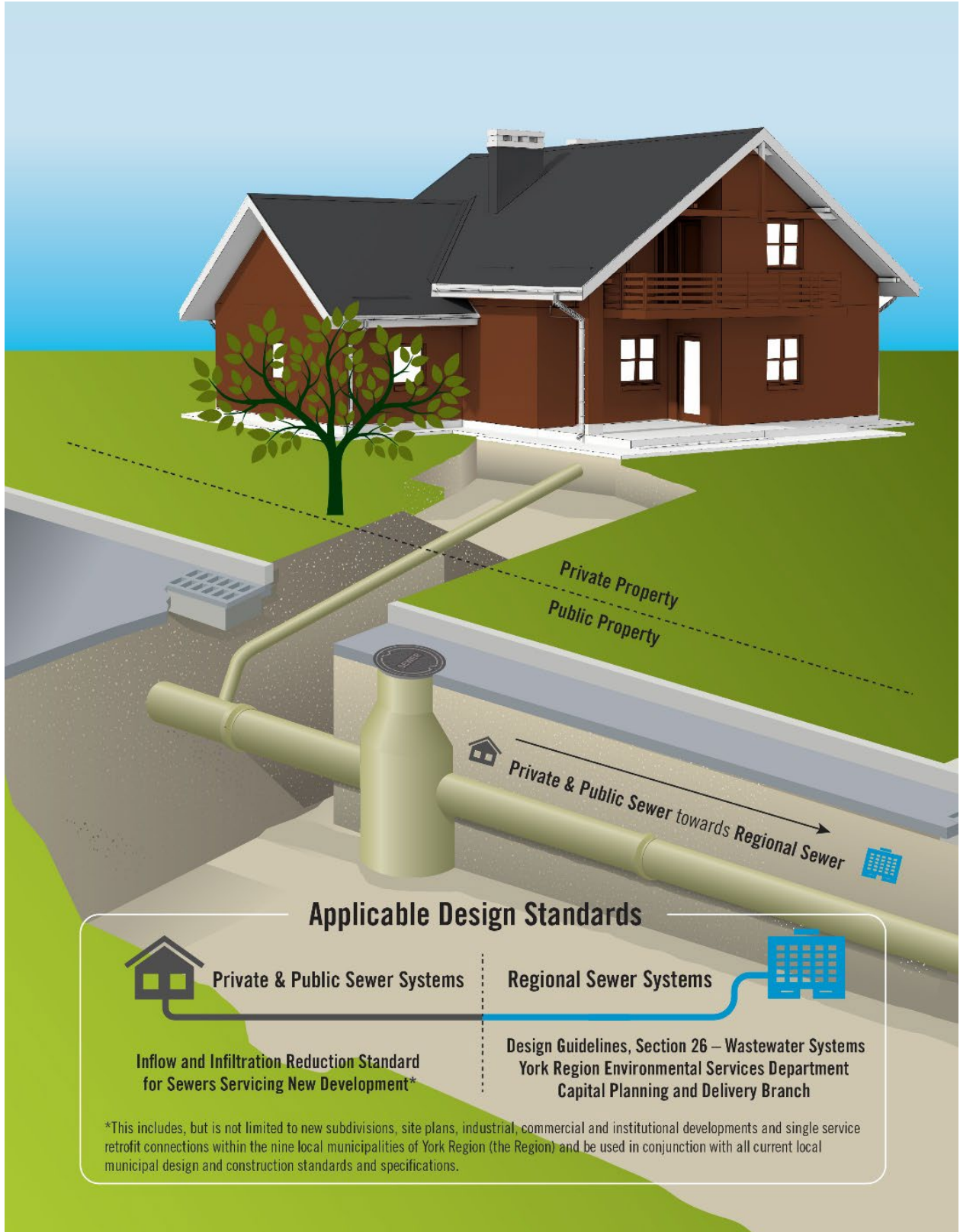

Applicable Design Standards



Private & Public Sewer Systems

Inflow and Infiltration Reduction Standard for Sewers Servicing New Development*

*This includes, but is not limited to new subdivisions, site plans, industrial, commercial and institutional developments and single service retrofit connections within the nine local municipalities of York Region (the Region) and be used in conjunction with all current local municipal design and construction standards and specifications.

Regional Sewer Systems



**Design Guidelines, Section 26 – Wastewater Systems
York Region Environmental Services Department
Capital Planning and Delivery Branch**



APPENDIX B:

DESIGN CRITERIA DECISION FLOW CHARTS

Sanitary Service Connections to Mainline Sewer

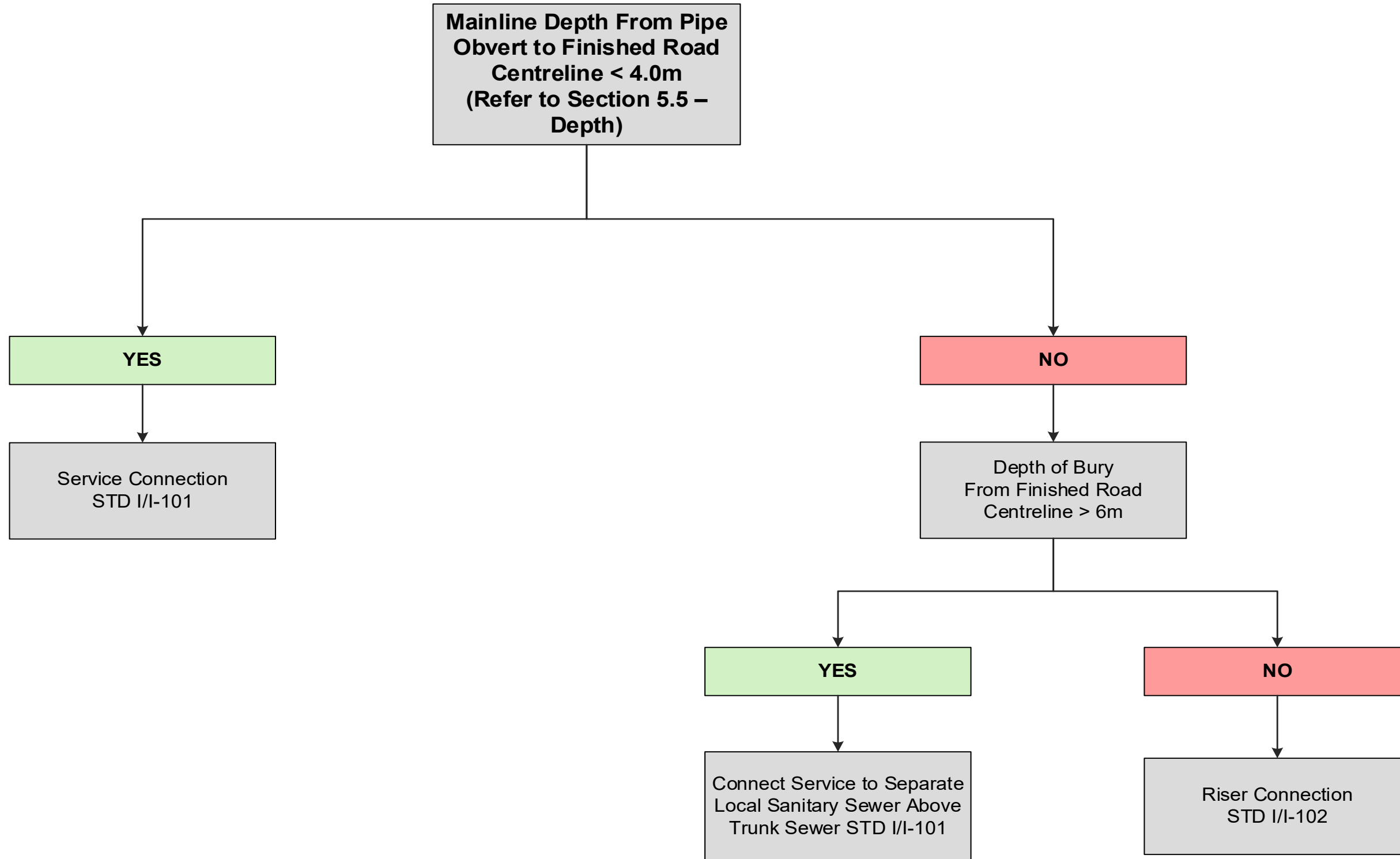

Sanitary Sewer Pipe Materials and Pipe Classifications

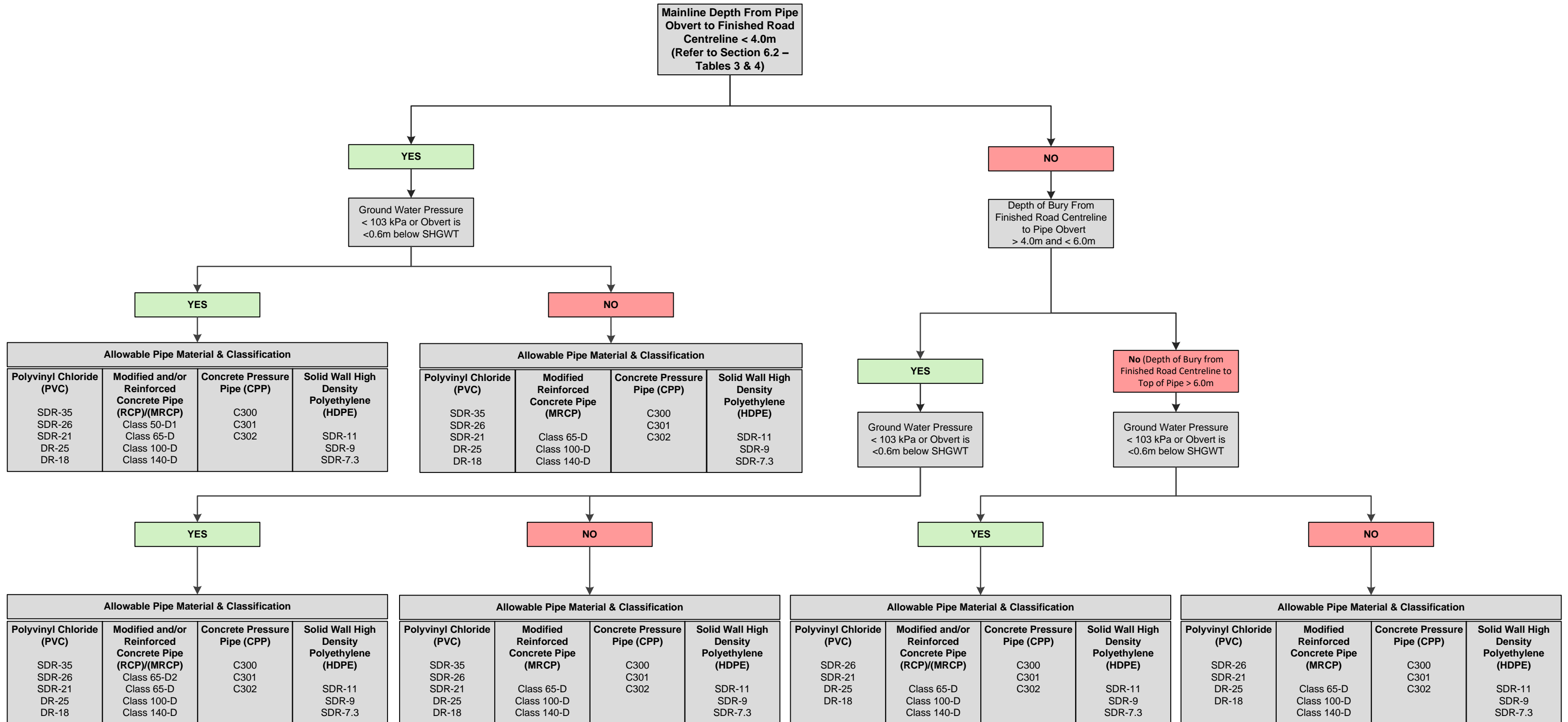

Sanitary Sewer Maintenance Hole Materials Criteria

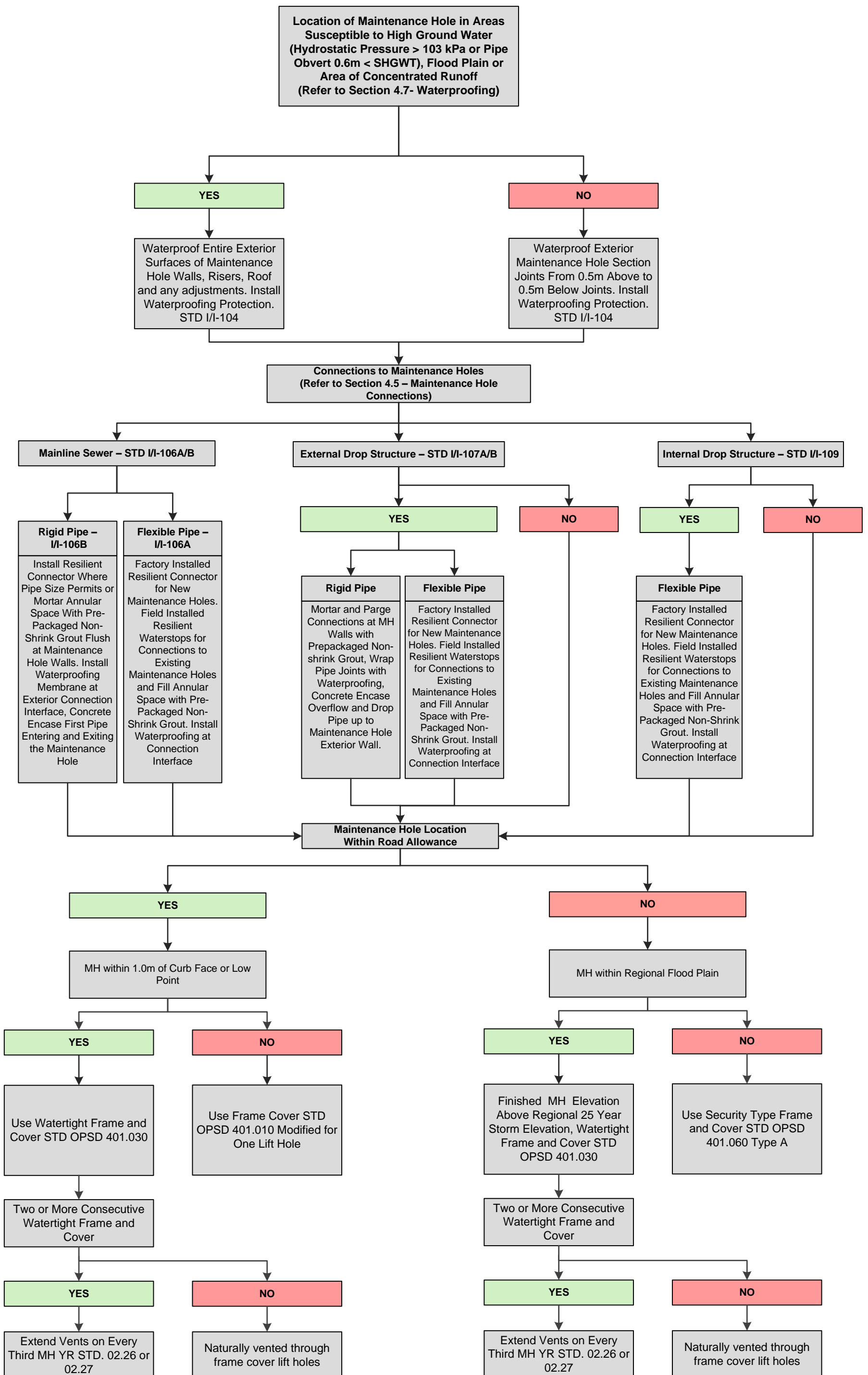

APPENDIX C: RECOMMENDED PRODUCTS AND SPECIFICATIONS

C1: Recommended waterproofing membranes and primers products

C2: Recommended geocomposite protection board products

C3: Recommended maintenance hole adjustment and frame and cover alternative products

C1 - RECOMMENDED WATERPROOFING MEMBRANES AND PRIMERS PRODUCTS

Manufacturer	Warm weather membrane	Compatible warm weather primer and minimum temperature application	Cold weather membrane product	Compatible cold weather primer/adhesive and minimum temperature application
GCP Applied Technologies	Bituthene 3000® (apply only in dry weather and air and surface temperatures above 5° C)	Bituthene primer WP-3000® (in dry weather above 4° C)	Bituthene low temperature membrane® (apply only in dry weather and air and surface temperatures above -4° C to 16° C)	Bituthene adhesive primer B2 LVC® (in dry weather above -4° C)
Henry Company	Blueskin WP200	Bakor Aquatic Emulsion Primer® (in dry weather and temperatures above -4° C)	Blueskin WP200®	Bakor Hi-Tac Construction Adhesive and Primer® or Blueskin Adhesive® (in dry weather and temperatures above -12° C)
Soprema	Colphene 3000 Summer Grade® (apply in dry weather and air and surface temperatures 10° C to 50° C)	Elastocol Stick H ₂ O® (minimum temperature application -4° C)	Colphene 3000 Winter Grade® (apply in dry weather and air and surface temperatures -10° C to 10° C)	Elastocol Stick Zero® (temperatures above -10° C), SopraSeal Stick Primer (temperatures above -30° C)
WR Meadows	MEL-ROL® (in dry weather and temperatures above 4° C)	MEL-PRIME WB® (in dry weather and temperatures above 4° C)	MEL-ROL LOW TEMP® (Canada) (apply in dry weather and air and surface temperatures -7° C to 16° C)	MEL-PRIME® (in dry weather and temperatures above -17.8° C)

C2 - RECOMMENDED GEOCOMPOSITE PROTECTION BOARD PRODUCTS

- Protection 03
- Polypropylene Protection Board
- Protection Course
- SOPRABOARD
- Or approved equivalent

C3 - RECOMMENDED MAINTENANCE HOLE ADJUSTMENT AND FRAMES AND COVER ALTERNATIVE PRODUCTS

Products in this category shall carry a 25-year manufacturers' guarantee on all system parts.

- Integrated Frame and Cover (IFC-25) Maintenance Hole
- ej SELFLEVEL®
- Bibby Autostable Self-Level Maintenance Hole Frame®
- Or approved equivalent

APPENDIX D:

INSPECTION & TESTING REPORTS

- 1. Maintenance hole inspection report**
- 2. Service connection inspection report**
- 3. Maintenance hole, mainline sewer and service connections air testing report**

MAINTENANCE HOLE INSPECTION REPORT			MAINTENANCE HOLE No. :	
Subdivision Name (If applicable):				
Municipal Subdivision File No/ Municipality Contract No.:				
Street Name:		Nearest Intersecting Street:		
Date:		Weather AM: Temperature:	Weather PM: Temperature:	
Sewer Contractor:		Engineering Consultant:		
Inspector Name:		Time On-Site: Time Off-Site:		
Depth of Maintenance Hole:		Height of Water Table Above Bottom of Maintenance Hole:		
Maintenance Hole Base: <input type="checkbox"/> Precast <input type="checkbox"/> Cast-in Place				
Maintenance Hole Adjustment: <input type="checkbox"/> Precast Concrete Riser <input type="checkbox"/> Cast-in Place Concrete <input type="checkbox"/> Precast Concrete Ring (1 maximum)		Waterproofing Membrane Product:	Primer Product:	
Maintenance Hole Mainline Connection(s)				
Pipe Diameter(mm):	Pipe Material: <input type="checkbox"/> PVC <input type="checkbox"/> RCP <input type="checkbox"/> CPP <input type="checkbox"/> HDPE	Waterproofing Membrane at Connection	Waterproofing Membrane Product:	Primer Product:
<input type="checkbox"/> Inlet <input type="checkbox"/> Outlet	Pipe Class:	Face: <input type="checkbox"/> YES <input type="checkbox"/> NO		
Pipe Diameter(mm):	Pipe Material: <input type="checkbox"/> PVC <input type="checkbox"/> RFC <input type="checkbox"/> CPP <input type="checkbox"/> HDPE	Waterproofing Membrane at Connection	Waterproofing Membrane Product:	Primer Product:
<input type="checkbox"/> Inlet <input type="checkbox"/> Outlet	Pipe Class:	Face: <input type="checkbox"/> YES <input type="checkbox"/> NO	<input type="checkbox"/> Same as above	<input type="checkbox"/> Same as above
Pipe Diameter(mm):	Pipe Material: <input type="checkbox"/> PVC <input type="checkbox"/> RFC <input type="checkbox"/> CPP <input type="checkbox"/> HDPE	Waterproofing Membrane at	Waterproofing Membrane Product:	Primer Product:

MAINTENANCE HOLE INSPECTION REPORT				MAINTENANCE HOLE No. :	
<input type="checkbox"/> Inlet <input type="checkbox"/> Outlet	Pipe Class:	Connection Face: <input type="checkbox"/> YES <input type="checkbox"/> NO	<input type="checkbox"/> Same as above	<input type="checkbox"/> Same as above	
Pipe Diameter(mm):	Pipe Material: <input type="checkbox"/> PVC <input type="checkbox"/> RFC <input type="checkbox"/> CPP <input type="checkbox"/> HDPE	Waterproofing Membrane at Connection Face: <input type="checkbox"/> YES <input type="checkbox"/> NO	Waterproofing Membrane Product: <input type="checkbox"/> Same as above	Primer Product:	
<input type="checkbox"/> Inlet <input type="checkbox"/> Outlet	Pipe Class:			<input type="checkbox"/> Same as above	
If Rigid Pipe Connection(s), First Pipe Concrete Encased: <input type="checkbox"/> YES <input type="checkbox"/> NO					
Drop Structure: Applicable <input type="checkbox"/> YES <input type="checkbox"/> NO					
External Drop: <input type="checkbox"/> Type A <input type="checkbox"/> Type B			<input type="checkbox"/> Field Installed <input type="checkbox"/> Factory Manufactured		
Through Pipe Diameter(mm):	Pipe Material: <input type="checkbox"/> PVC <input type="checkbox"/> RFC	Waterproofing Membrane at Connection Face: <input type="checkbox"/> YES <input type="checkbox"/> NO	Waterproofing Membrane Product:	Primer Product:	
Drop Pipe Diameter(mm):					
Maintenance Hole Waterproofing					
Static Water Table Above Base of Maintenance Hole	<input type="checkbox"/> YES. Waterproof All Concrete Surface Above Base	Waterproofing Membrane Product:	Primer Product:	Protection Board Product:	
	<input type="checkbox"/> No. Waterproof 0.5m Above and Below All External Joints	Waterproofing Membrane Product:	Primer Product:	Protection Board Product:	

Attach Photos:

1. Maintenance Hole Base
2. Maintenance Hole Adjustment Before Installation Waterproofing Membrane
3. Maintenance Hole Adjustment After Installation Waterproofing Membrane
4. All Maintenance Holes Connections:
 - a. For Rigid Pipes after Mortaring and Parging Inside and Outside Wall Faces
 - b. For Rigid Pipes after Priming and Waterproofing Membrane Installation

- c. For Rigid Pipes after Placement of Concrete Encasement for First Pipe Length Entering and Exiting
 - d. Flexible Pipes after connection to Factory Installed Resilient Connector or Field Installed Waterstops Mortaring and Parging Inside and Outside Wall Faces
- 5. Drop Structures:
 - a. For Rigid Pipes after Mortaring and Parging Inside and Outside Wall Faces
 - b. For Rigid Pipes after Priming and Waterproofing Membrane Installation
 - c. Flexible Pipes after connection to Factory Installed Resilient Connector or Field Installed Waterstops Before and After Mortaring and Parging Inside and Outside Wall Faces
- 6. Maintenance Hole Waterproofing:
 - a. After Priming
 - b. After Installing Waterproofing Membrane
 - c. After Installing Protection Board
 - d. After Placing Sand Fill

SERVICE CONNECTION INSPECTION REPORT

Subdivision Name (if Applicable):

Municipal Subdivision File No./Municipality Contract No.:

Street Name:

Nearest Intersecting Street:

Date:

Weather:

Temperature:

Sewer Contractor:

Engineering Consultant:

Inspector Name:

Time On-Site:

Time Off-Site:

Average Depth of Mainline Sewer:

Risers Required: YES NO

Lot No.(s)/Addresses(es)

Single Service (125mm Diameter)
 Shared Service (150mm Diameter) Note:
 Difference between two Basement Elevations
 must be less than 0.2m

Mainline Sewer Pipe
 Material: PVC RFC

Resilient Connector for
 RFC Pipe
 Factory Installed
 Pipe Cored and Field
 Installed

Confirm Factory
 Manufactured Tee for
 PVC Mainline Sewer
 Pipe
 YES

Confirm All PVC Pipe
 Homed into Pipe Bells
 and Fittings up to
 Markings
 YES

Average Depth of
 Mainline Sewer:

Riser Required:
 YES NO

Connection to Mainline
 Sewer Above Springline
 and 45° from Horizontal:
 YES NO

Settlement Joint
 Installed for Riser:
 YES NO

Length of Service
 Connection Extension
 Beyond Property
 Line(m):

WYE Connection
 Installed 1.0m from
 Property Line within
 Roadway:
 YES NA

Service Connection
 Cover Material:
 Crushed Stone
 Lean Concrete

Backfill Material:
 Granular
 Native

Average Depth of Mainline Sewer:

Risers Required: YES NO

SERVICE CONNECTION INSPECTION REPORT

Lot No.(s)/Addresses(es)		<input type="checkbox"/> Single Service (125mm Diameter) <input type="checkbox"/> Shared Service (150mm Diameter) Note: Difference between two Basement Elevations must be less than 0.2m	
Mainline Sewer Pipe Material: <input type="checkbox"/> PVC <input type="checkbox"/> RFC	Resilient Connector for RFC Pipe <input type="checkbox"/> Factory Installed <input type="checkbox"/> Pipe Cored and Field Installed	Confirm Factory Manufactured Tee for PVC Mainline Sewer Pipe <input type="checkbox"/> YES	Confirm All PVC Pipe Homed into Pipe Bells and Fittings up to Markings <input type="checkbox"/> YES
Elevation of Cap Beyond Property Line:	Riser Required: <input type="checkbox"/> YES <input type="checkbox"/> NO	Connection to Mainline Sewer Above Springline and 45° from Horizontal: <input type="checkbox"/> YES <input type="checkbox"/> NO	Settlement Joint Installed for Riser: <input type="checkbox"/> YES <input type="checkbox"/> NO
Length of Service Connection Extension Beyond Property Line(m):	WYE Connection Installed 1.0m from Property Line within Roadway: <input type="checkbox"/> YES <input type="checkbox"/> NA	Service Connection Cover Material: <input type="checkbox"/> Crushed Stone <input type="checkbox"/> Lean Concrete	Backfill Material: <input type="checkbox"/> Granular <input type="checkbox"/> Native
Average Depth of Mainline Sewer:		Risers Required: <input type="checkbox"/> YES <input type="checkbox"/> NO	
Lot No.(s)/Addresses(es)		<input type="checkbox"/> Single Service (125mm Diameter) <input type="checkbox"/> Shared Service (150mm Diameter) Note: Difference between two Basement Elevations must be less than 0.2m	
Mainline Sewer Pipe Material: <input type="checkbox"/> PVC <input type="checkbox"/> RCP	Resilient Connector for RCP Pipe <input type="checkbox"/> Factory Installed <input type="checkbox"/> Pipe Cored and Field Installed	Confirm Factory Manufactured Tee for PVC Mainline Sewer Pipe <input type="checkbox"/> YES	Confirm All PVC Pipe Homed into Pipe Bells and Fittings up to Markings <input type="checkbox"/> YES
Average Depth of Mainline Sewer:	Riser Required: <input type="checkbox"/> YES <input type="checkbox"/> NO	Connection to Mainline Sewer Above Springline and 45° from Horizontal: <input type="checkbox"/> YES <input type="checkbox"/> NO	Settlement Joint Installed for Riser: <input type="checkbox"/> YES <input type="checkbox"/> NO
Length of Service Connection Extension Beyond Property Line(m):	WYE Connection Installed 1.0m from Property Line within Roadway: <input type="checkbox"/> YES <input type="checkbox"/> NA	Service Connection Cover Material: <input type="checkbox"/> Crushed Stone <input type="checkbox"/> Lean Concrete	Backfill Material: <input type="checkbox"/> Granular <input type="checkbox"/> Native

Attach Photos:

1. Service Connection at Mainline Sewer
2. Wye Fittings within Roadway
3. Riser Sections Including Settlement Joint
4. Reducer, Service Connection Extension Beyond Property Line and Termination Cap
5. Service Connection Bedding and Cover Prior to Backfilling

MAINTENANCE HOLE, MAINLINE SEWER AND SERVICE CONNECTIONS AIR TESTING REPORT

Subdivision Name (If applicable):

Municipal Subdivision File No./Municipality Contract No.:

Street Name:

Nearest Intersecting Street:

Date:

Weather:
Temperature:

Sewer Contractor:

Engineering Consultant:

Inspector Name:

Time On-Site:
Time Off-Site:

Upstream Maintenance Hole No.:

Downstream Maintenance Hole No.:

Mainline Sewer and Service Connections with Public/Private Roadway:

Height of Water Table Above Bottom of Downstream Maintenance Hole:

Average Sewer Pipe Depth for Test Segment:

Sewer Pipe Diameter(mm) within Test Segment:

Sewer Pipe Material:
 PVC RFC CPP HDPE

Mainline Sewer Pipe Test Segment Length (m):

Lot No's./Addresses of Service Connections within Sewer Test Segment:

Total Estimated Length of Service Connections for Sewer Test Segment:
 125mm Diameter (m):
 150mm Diameter (m):
 Other _____ Diameter (m):

Air Pressure Start of Test (kPa/psi):

First Test
 Retest

Air Pressure End of Test (kPa/psi):

Pass
 Fail

Maintenance Hole Air Test:

Maintenance Hole No.:

Volume of Maintenance Hole(m³):

MAINTENANCE HOLE, MAINLINE SEWER AND SERVICE CONNECTIONS AIR TESTING REPORT

Air Pressure Start of Test (kPa/psi):	<input type="checkbox"/> First Test <input type="checkbox"/> Retest	Air Pressure End of Test (kPa/psi):	<input type="checkbox"/> Pass <input type="checkbox"/> Fail
Maintenance Hole No.:		Volume of Maintenance Hole(m ³):	
Air Pressure Start of Test (kPa/psi):	<input type="checkbox"/> First Test <input type="checkbox"/> Retest	Air Pressure End of Test (kPa/psi):	<input type="checkbox"/> Pass <input type="checkbox"/> Fail

STANDARD DRAWINGS

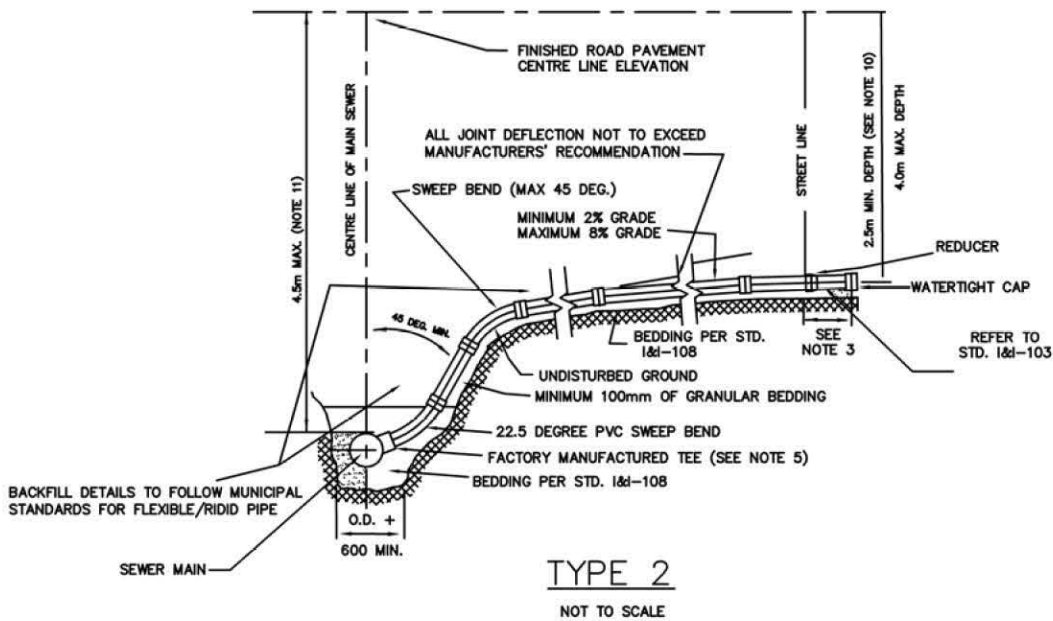
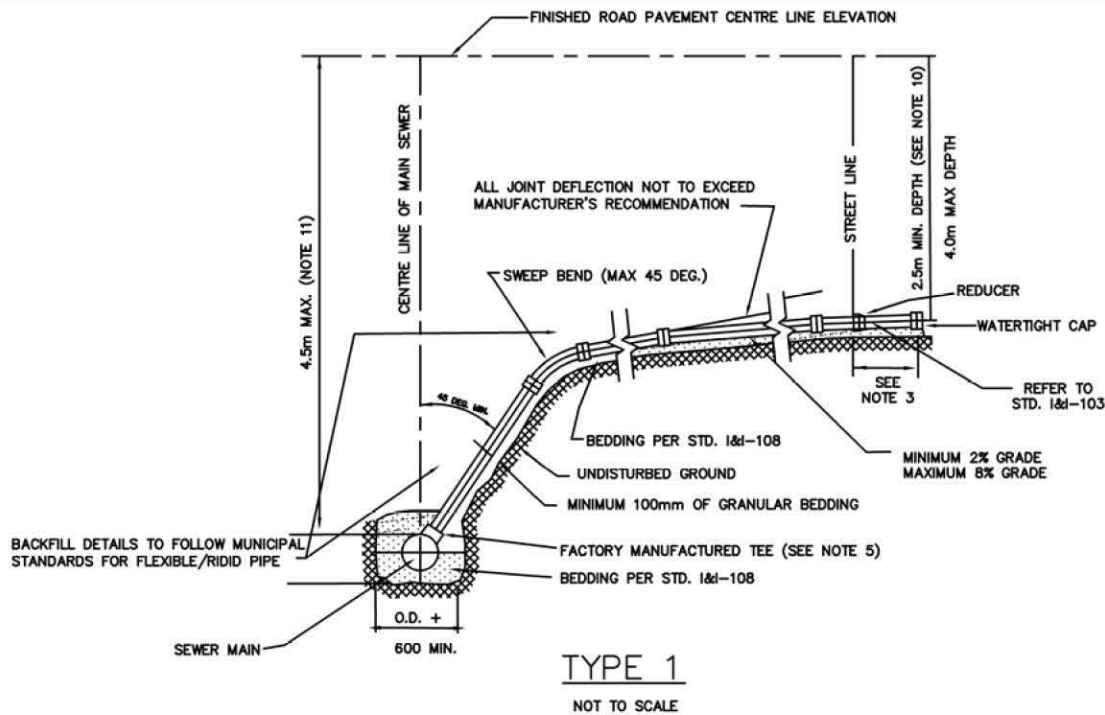

NOTES:

1. RISER CONNECTIONS SHALL BE USED WHEN MAIN SEWER DEPTH IS GREATER THAN 4.5m FROM CENTRELINE OF FINISHED ROAD PAVEMENT TO THE OBVERT OF SEWER MAIN.
2. RISER CONNECTION TYPE 1 AND 2 SHALL BE USED WHEN WALLS OF EXCAVATION ARE A MINIMUM 45 FROM VERTICAL
3. IN NEW SUBDIVISIONS, THE SEWER CONNECTION SHALL BE LAID FROM THE SEWER MAIN TO 1.0m - 1.5m BEYOND THE STREET LINE AND PLUGGED WITH WATERTIGHT CAP
4. ALL CUTTING AND MACHINING SHALL BE DONE BY THE CONTRACTOR.
5. CONNECTIONS SHALL BE MADE USING FACTORY MANUFACTURED TEES FOR NEW/EXISTING PVC SEWER MAINS AND FACTORY INSTALLED RESILIENT ADAPTERS FOR NEW REINFORCED CONCRETE PIPE SEWER MAINS. CONNECTING TO EXISTING REINFORCED CONCRETE PIPE SHALL BE CORE DRILLED AND HAVE FIELD INSTALLED RESILIENT ADAPTERS.
6. FACTORY MANUFACTURED PVC OR RESILIENT COUPLINGS SHALL BE USED WHEN CONNECTION IS MADE TO AN EXISTING LATERAL AT THE PROPERTY LINE.
7. COVER OVER SANITARY SEWER CONNECTIONS SHALL BE A MINIMUM 300mm AND EITHER, CRUSHER RUN LIMESTONE, OR HL6 STONE IS TO EXTEND FROM SPRINGLINE OF SEWER TO TOP OF UPPER MOST SWEEP BEND.
8. INSTALLATION MUST CONFORM TO MANUFACTURERS' SPECIFICATIONS
9. PVC PIPE SHALL BE SDR 28 AND GREEN IN COLOUR
10. MINIMUM DEPTH OF SERVICE CONNECTION TO SUIT BASEMENT ELEVATION
11. WHERE DEPTH OF SEWER MAIN EXCEEDS 4.5M, REFER TO STANDARD NO. I&I-102
12. WHERE THE WALLS OF THE EXCAVATION ARE LESS THAN 30 DEGREES FROM THE VERTICAL CENTERLINE OF THE MAIN SEWER

SANITARY SEWER
CONNECTIONS FOR
RESIDENTIAL DEVELOPMENTS
(100MM, 125MM AND 150MM DIA. PIPE)

DRAWN-BY

DATE 10-29-21

STANDARD NO. I&I-101

DETAIL

FIELD MADE CONTROLLED SETTLEMENT JOINT

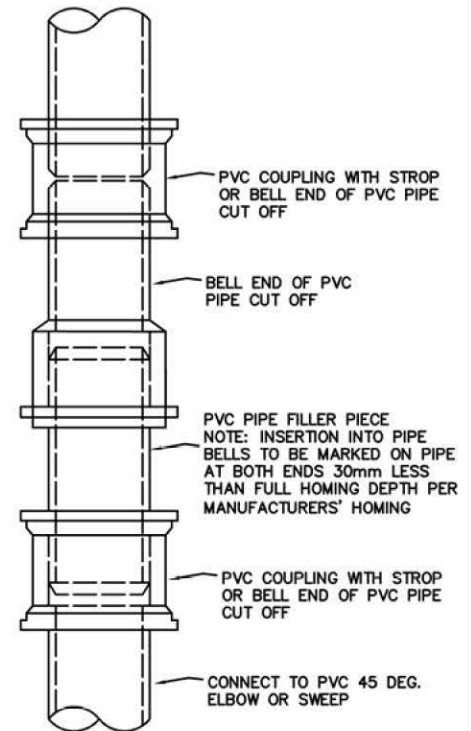

NOTE: ALL PIPE AND FITTINGS TO BE OF THE SAME SDR AS REMAINDER OF SEWER LATERAL AND RISER

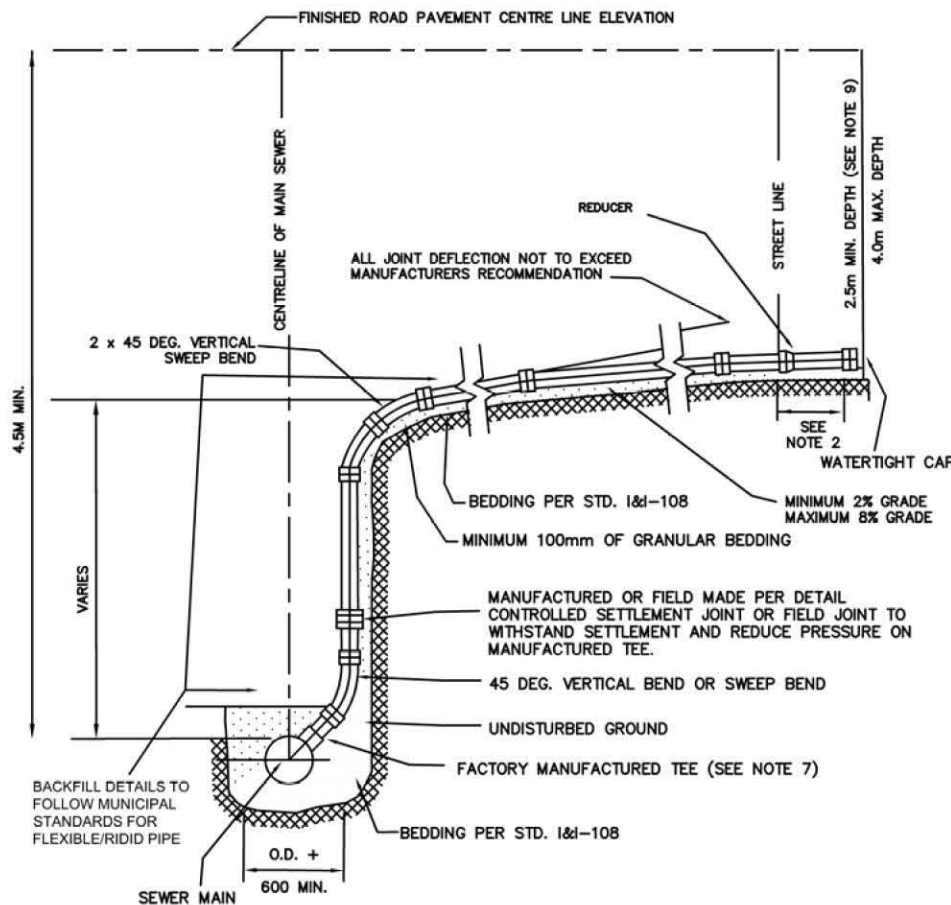

LEGEND: O.D. = OUTSIDE DIAMETER
SDR = STANDARD DIMENSION RATIO

NOT TO SCALE

NOTES:

1. RISER CONNECTIONS SHALL BE USED WHEN MAIN SEWER DEPTH IS GREATER THAN 4.5m FROM CENTRELINE OF PAVEMENT TO THE OBVERT OF MAIN SEWER OR WHEN THE WALLS OF THE EXCAVATION ARE LESS THAN 30 DEGREES FROM THE VERTICAL CENTRELINE OF THE MAIN SEWER MAIN.
2. IN NEW SUBDIVISIONS, THE SEWER CONNECTION SHALL BE LAID FROM THE SEWER MAIN TO 1.0m - 1.5m BEYOND THE PROPERTY LINE AND PLUGGED WITH WATERTIGHT CAP
3. CONNECTIONS SHALL BE MADE USING FACTORY MANUFACTURED TEES FOR NEW/EXISTING PVC SEWER MAINS AND FACTORY INSTALLED RESILIENT ADAPTERS FOR NEW REINFORCED CONCRETE PIPE SEWER MAINS. CONNECTIONS TO EXISTING REINFORCED CONCRETE PIPE SHALL BE CORE DRILLED AND HAVE FIELD INSTALLED RESILIENT ADAPTERS.
4. FACTORY MANUFACTURED PVC OR RESILIENT COUPLING SHALL BE USED WHEN CONNECTION IS MADE TO AN EXISTING LATERAL AT PROPERTY LINE.
5. ALL CUTTING AND MACHINING SHALL BE DONE BY THE CONTRACTOR.
6. COVER OVER SANITARY SEWER CONNECTIONS SHALL BE A MINIMUM 300mm AND EITHER CRUSHER RUN LIMESTONE OR HL6 STONE.
7. INSTALLATION MUST CONFORM TO MANUFACTURERS SPECIFICATIONS.
8. PVC PIPE SHALL BE SDR 28 AND GREEN IN COLOUR
9. MINIMUM DEPTH OF SERVICE CONNECTION TO SUIT BASEMENT ELEVATION
10. MANUFACTURED SETTLEMENT CONTROL JOINT CONFORMING TO CSA B182.2 AND ASTM D3034

SANITARY LATERALS IN AREAS WHERE THE DEPTH OF THE SEWER MAIN OBVERT EXCEEDS 4.5M FROM THE ROAD CENTRELINE ELEVATIONS

DRAWN-BY

DATE 10-29-21

STANDARD NO. I&I-102

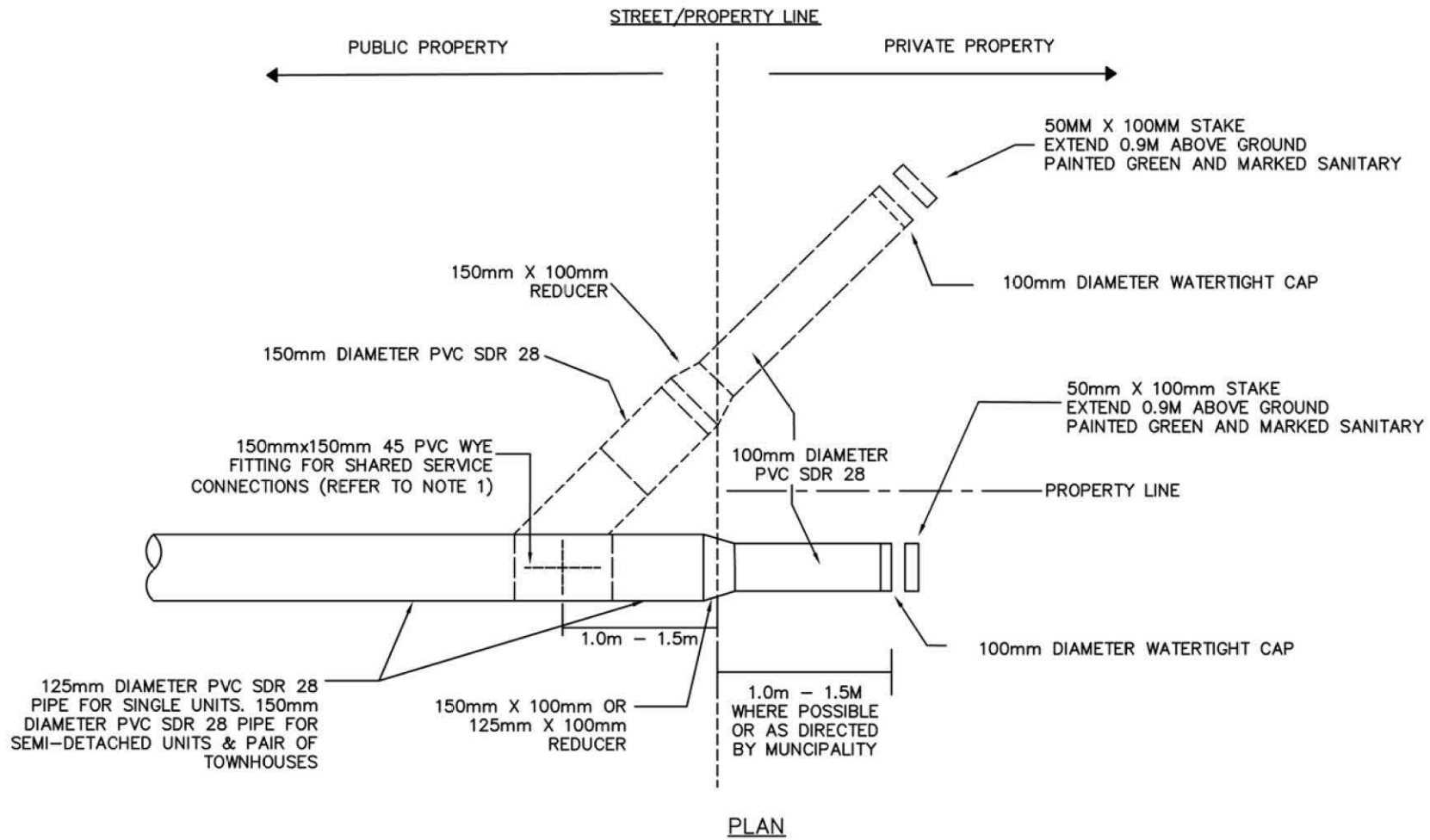

NOT TO SCALE

NOTES:

1. SHARED SERVICE CONNECTIONS, WHERE PERMITTED BY THE MUNICIPALITY, FOR EITHER A SEMI-RESIDENTIAL DWELLING OR A PAIR OF TOWNHOUSES TO HAVE AN 150MM X 150MM - 45 DEGREE PVC PIPE FITTING INSTALLED 1.0m - 1.5M FROM THE PROPERTY LINE
2. THE REDUCTION FROM 150MM TO 100MM DIAMETER PIPE ON THE PRIVATE PROPERTY IS AT THE DISCRETION OF THE LOCAL MUNICIPALITY

SANITARY SERVICE CONNECTIONS AT THE PROPERTY LINE FOR SINGLE, SEMI RESIDENTIAL DWELLING AND TOWN HOME UNITS
(WHERE PERMITTED BY THE MUNICIPALITY)

DRAWN-BY

DATE 10-29-21

STANDARD NO. I&I-103

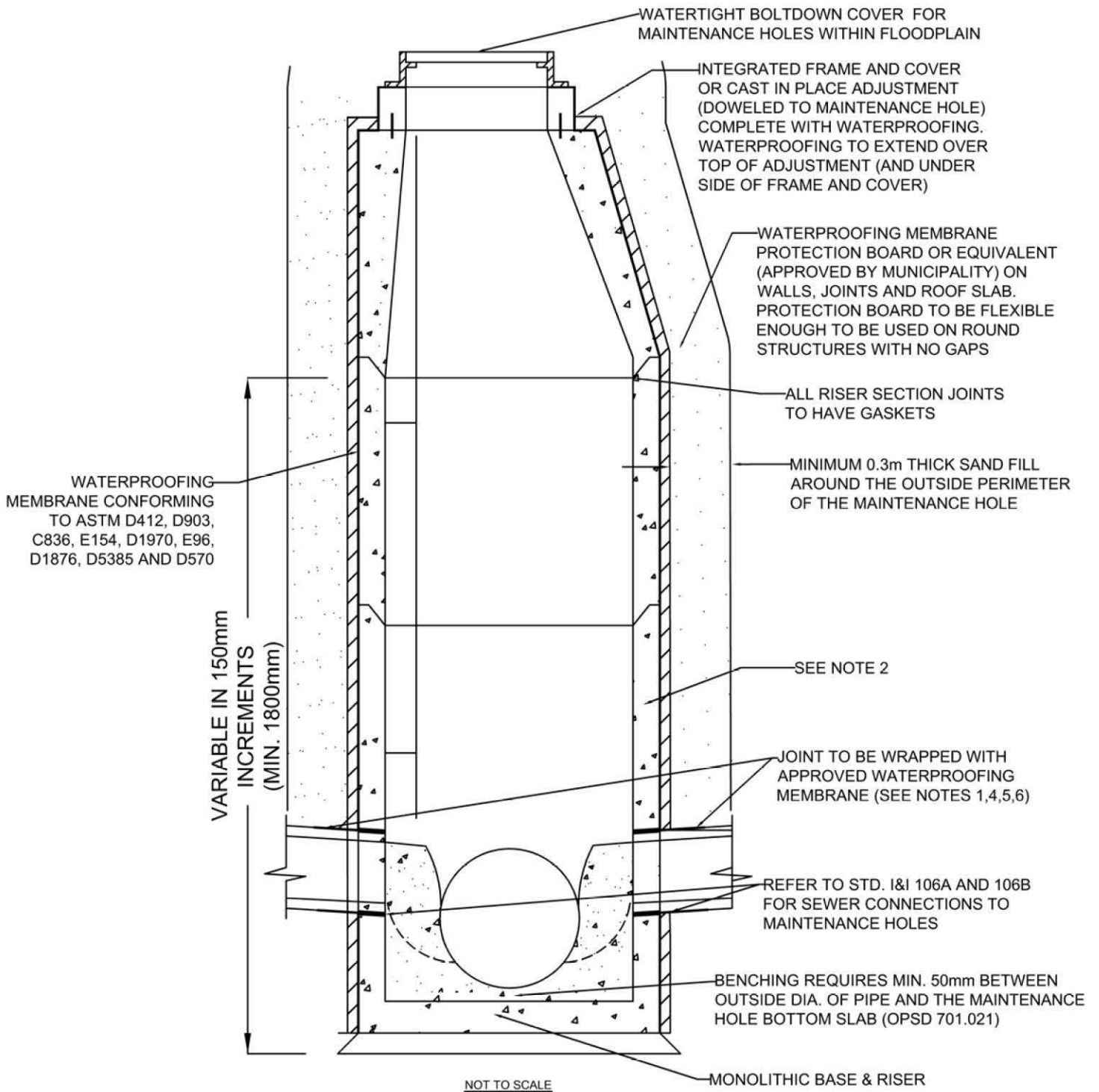

NOTES:

1. MAINTENANCE HOLES LOCATED WITHIN FLOODPLAINS AND/OR AREAS WITH HIGH GROUNDWATER, DEFINED AS, HYDROSTATIC ORESSURE GREATER THAN 85 KPA AND/OR WHERE THE SEWER OBVERT IS 0.5M OR MORE BELOW THE SEASON HIGH GROUNDWATER TABLE ARE TO BE FULLY WATERPROOFED. THE ENTIRE EXTERNAL SURFACE AREA OF THE MAINTENANCE HOLE, INCLUDING ALL WALLS, JOINTS, ADJUSTMENT SECTIONS AND ROOF SLAB SHALL BE WRAPPED IN A WATERPROOFING MEMBRANE. WACH WATERPROOFING MEMBRANE LAYER SHALL OVERLAP A MINIMUM OF 0.15M.
2. MAXIMUM RISER HEIGHT AS PRACTICAL SHALL BE USED TO ALLEVIATE INFILTRATION THROUGH RISER SEGMENT JOINTS
3. REFER TO STANDARDS NO. I&I-106A/B FOR MAINLINE TO MAINTENANCE HOLE CONNECTIONS
4. FLEXIBLE SEWER PIPE CONNECTIONS TO NEW MAINTENANCE HOLES SHALL HAVE FACTORY INSTALLED RESILIENT CONNECTORS IN THE STRUCTURE OPENINGS
5. FLEXIBLE SEWER PIPE CONNECTIONS TO EXISTING MAINTENANCE HOLES SHALL HAVE WATER STOPS INSTALLED AND THE ANNULAR SPACE FILLED WITH PRE-PACKAGED NON-SHRINK GROUT FLUSH WITH THE EXTERNAL WALLS OF THE MAINTENANCE HOLES. WATERPROOFING MEMBRANE SHALL BE INSTALLED AND EXTEND 0.3m BEYOND THE POINT OF CONNECTION AROUND THE PIPE AND ON THE MAINTENANCE HOLES EXTERNAL WALLS
6. RIGID SEWER PIPE MAINLINE CONNECTIONS TO MAINTENANCE HOLES SHALL BE WITH A RESILIENT CONNECTOR FOR NEW INSTALLATIONS WHERE PIPE SIZES PERMIT. THE ANNULAR SPACE SHALL BE MORTARED WITH PRE-PACKAGED NON-SHRINK GROUT WHERE A RESILIENT CONNECTOR CANNOT BE INSTALLED OR FOR CONNECTIONS TO EXISTING MAINTENANCE HOLES. WATERPROOFING MEMBRANE SHALL BE INSTALLED AND EXTEND 0.3M BEYOND THE POINT OF CONNECTION AROUND THE PIPE AND ON THE MAINTENANCE HOLE EXTERNAL WALL.
7. BENCHING DETAILS REFER TO OPSD 701.021
8. REFER TO OTHER MAINTENANCE HOLE STANDARDS FOR SIZING, CONFIGURATIONS AND STRUCTURAL ELEMENTS

WATERPROOFING MEMBRANE SYSTEM FOR MAINTENANCE HOLES WITHIN AREAS SUSCEPTIBLE TO HIGH GROUNDWATER OR LOCATED WITHIN FLOODPLAINS, AREAS OF CONCENTRATED RUNOFF

DRAWN-BY

DATE 10 - 29 - 21

STANDARD NO. I&I - 104

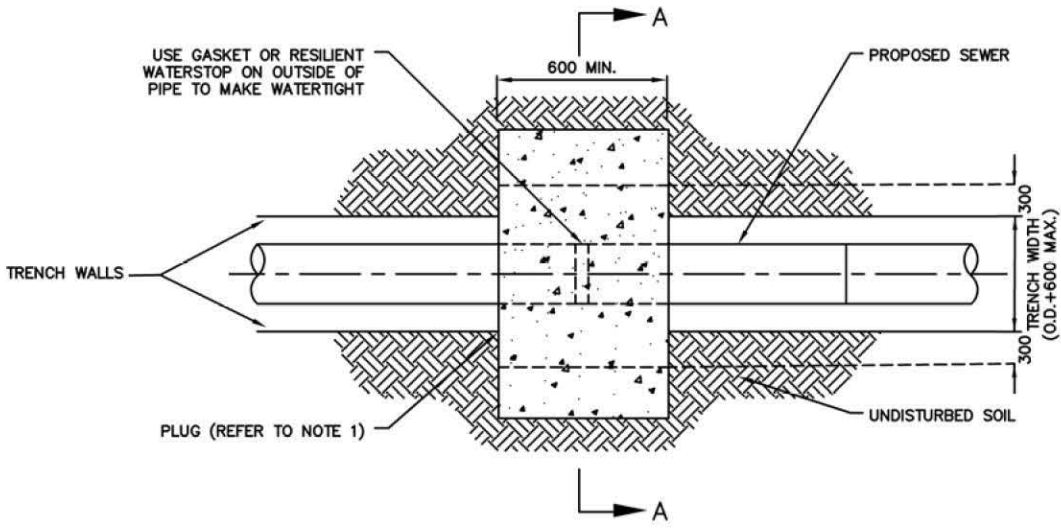

PLAN

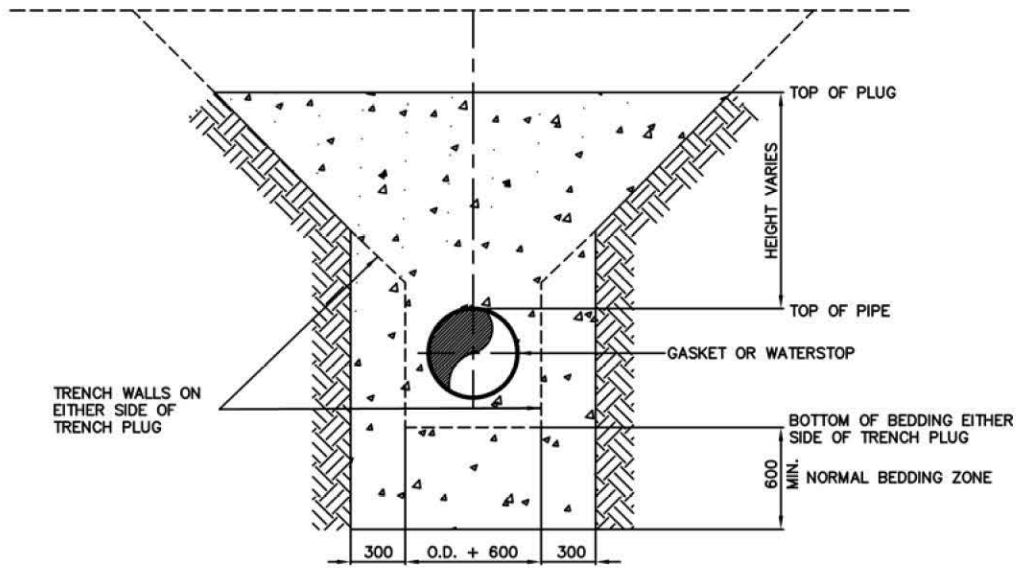

SECTION A-A

LEGEND: O.D. = OUTSIDE DIAMETER
SDR = STANDARD DIMENSION RATIO

NOT TO SCALE

NOTES:

1. TRENCH PLUGS SHALL BE CONSTRUCTED OF A BENTONITE MIXTURE, IMPORTED OR NATIVE CLAYS, O.REG. 153/04 AS APPROVED BY A GEOTECHNICAL ENGINEER. ALL NATIVE AND IMPORTED MATERIAL TO MEET MECP SOIL, GROUNDWATER AND SEDIMENT STANDARDS FOR USE UNDER PART XV.1 OF THE EPA TABLE 1 CRITERIA.
2. PLUGS SHALL EXTEND 300mm INTO UNDISTURBED GROUND ON SIDES OF TRENCH WHETHER OPEN CUT OR VERTICAL TRENCH.
3. TRENCH PLUGS SPACING AND HEIGHT AS PER GEOTECHNICAL ENGINEER RECOMMENDATIONS.
4. LOCATIONS OF PLUGS MAY BE ADJUSTED TO AVOID OBSTACLES.
5. ALL DIMENSIONS IN mm

	SEWER TRENCH PLUG	DRAWN-BY
		DATE 10 - 29 - 21
		STANDARD NO. I&I - 105

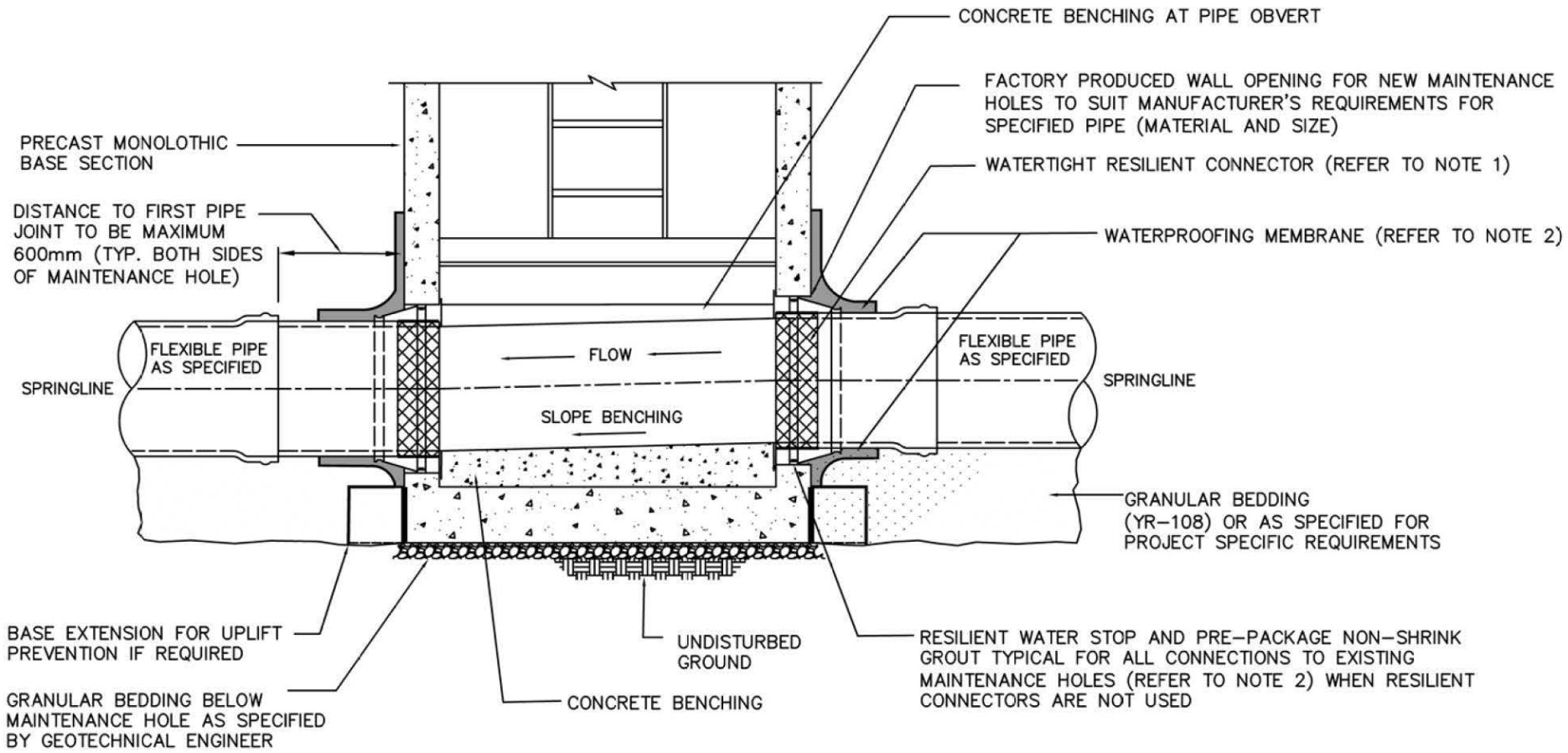

NOTES:

1. FLEXIBLE SEWER PIPE CONNECTIONS TO NEW MAINTENANCE HOLES SHALL HAVE FACTORY INSTALLED RESILIENT CONNECTORS IN STRUCTURE OPENING.
2. FLEXIBLE SEWER PIPE CONNECTIONS TO EXISTING MAINTENANCE HOLES SHALL HAVE RESILIENT WATER STOPS INSTALLED AND ANNULAR SPACE FILLED WITH PRE-PACKAGED NON-SHRINK GROUT FLUSH WITH EXTERNAL AND INTERNAL WALLS OF MAINTENANCE HOLES. WATERPROOFING SHALL BE INSTALLED AND EXTEND 0.3m BEYOND THE POINT OF CONNECTION AROUND THE PIPE
3. RESILIENT CONNECTORS AND WATERSTOPS SHALL CONFORM TO ASTM C923
4. PRE-PACKAGED NON-SHRINK GROUT SHALL CONFORM TO ASTM C1107
5. WATERPROOFING MEMBRANE SHALL CONFORM TO ASTM D412, D903, C836, E154, D1970, E96, D1876, D5385 AND D570
6. BENCHING DETAILS REFER TO OPSD 701.021

SANITARY SEWER MAINLINE TO
MAINTENANCE HOLE CONNECTION
FOR FLEXIBLE SEWER PIPE

DRAWN-BY

DATE 10-29-21

STANDARD NO. |&|-106A

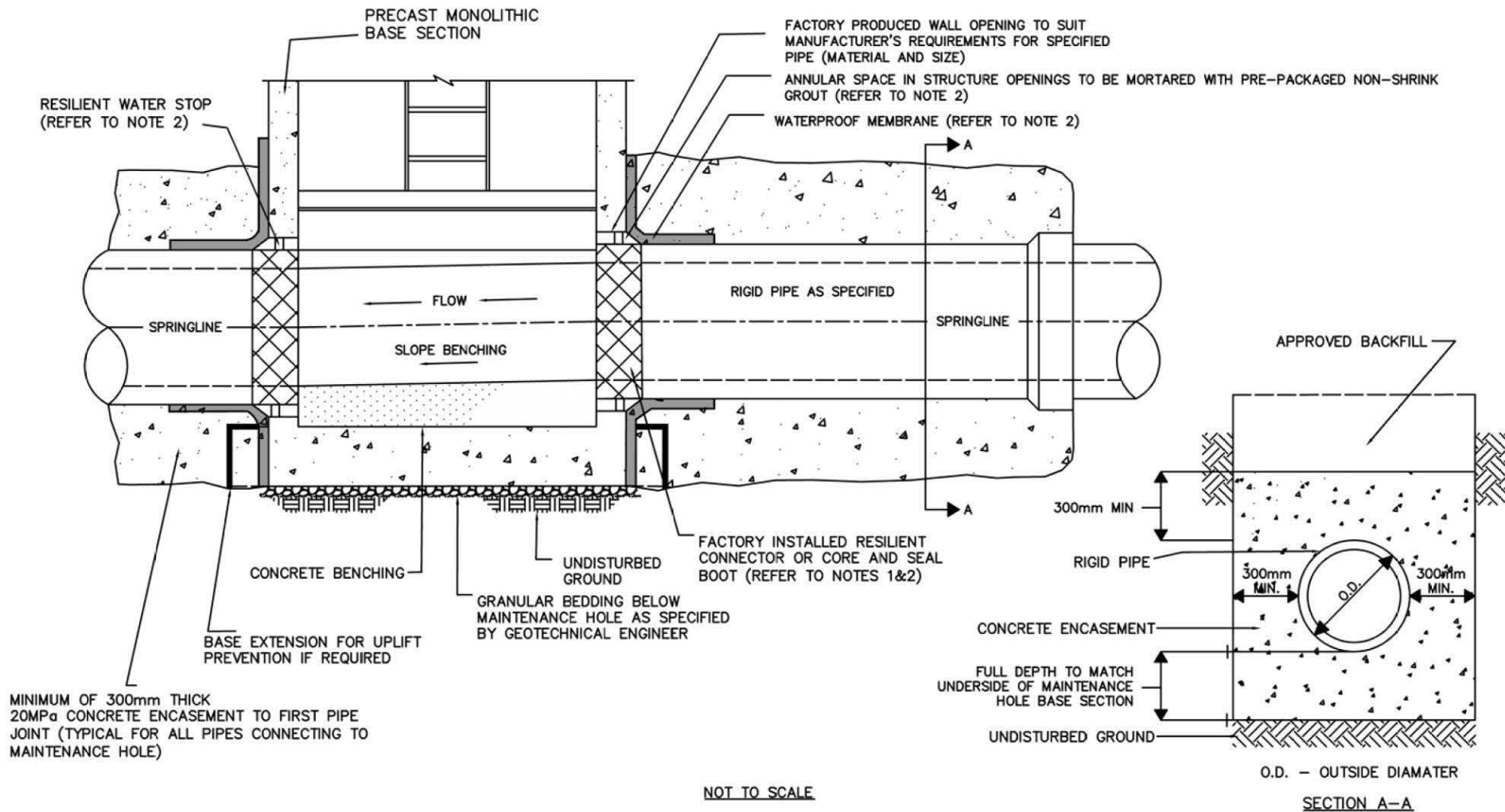

NOTES:

1. RIGID SEWER PIPE MAINLINE CONNECTIONS TO MAINTENANCE HOLES SHALL BE MADE WITH A RESILIENT CONNECTOR FOR NEW INSTALLATIONS WHERE PIPE SIZES PERMIT. THE ANNULAR SPACE SHALL BE MORTARED WITH PRE-PACKAGED NON-SHRINK GROUT WHERE A RESILIENT CONNECTOR CANNOT BE INSTALLED OR FOR CONNECTIONS TO EXISTING MAINTENANCE HOLES. THE WATERPROOFING MEMBRANE SHALL BE INSTALLED AND EXTEND 0.3m BEYOND THE POINT OF CONNECTION AROUND THE PIPE AND ON THE MAINTENANCE HOLE EXTERNAL WALL.
2. RIGID SEWER PIPE CONNECTIONS TO EXISTING MAINTENANCE HOLES AND SHALL HAVE RESILIENT WATER STOPS OR CORE AND SEAL BOOTS
3. RESILIENT CONNECTORS AND WATERSTOPS SHALL CONFORM TO ASTM C923
4. PRE-PACKAGED NON-SHRINK GROUT SHALL CONFORM TO ASTM C1107
5. WATERPROOFING MEMBRANE SHALL CONFORM TO ASTM D412, D903, C836, E154, D1970, E96, D1876, D5385 AND D570
6. BENCHING DETAILS REFER TO OPSD 701.021

SANITARY SEWER MAINLINE TO
MAINTENANCE HOLE CONNECTION
FOR RIGID SEWER PIPE

DRAWN-BY

DATE 10-29-21

STANDARD NO. I&I-106B

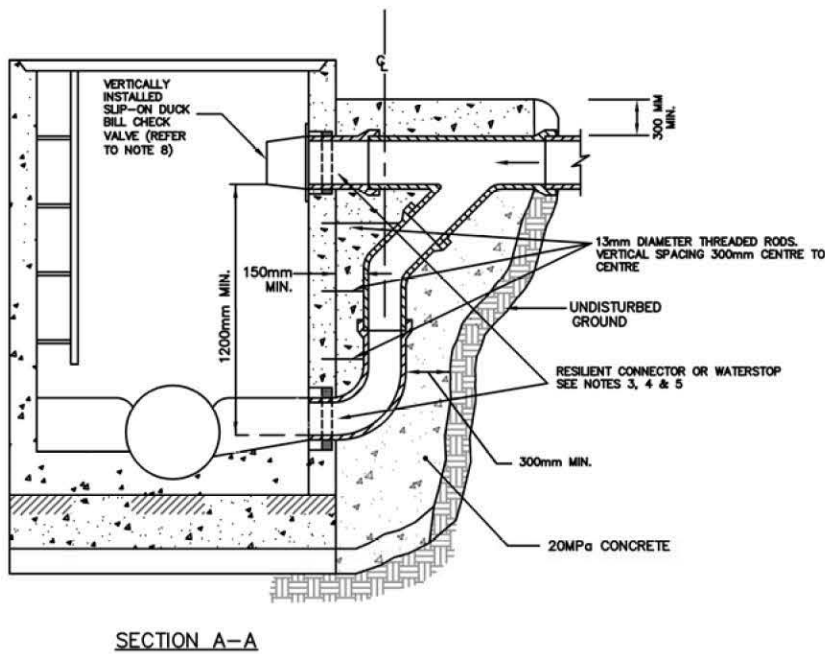
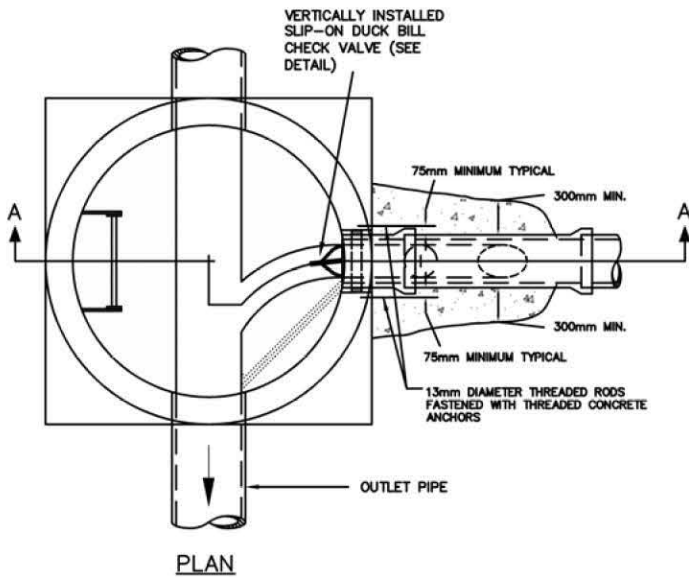

NOT TO SCALE

DETAIL

SLIP-ON DUCK BILL CHECK VALVE

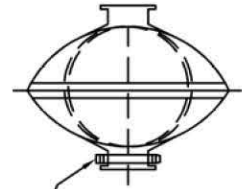

FRONT VIEW

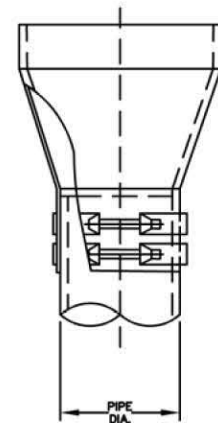

SIDE VIEW

NOTES:

1. DROP STRUCTURE TO BE COMPLETELY ENCASED IN 300mm OF 20MPa CONCRETE AND SECURED TO THE MAINTENANCE HOLE WITH 450mm LONG, 13mm ϕ THREADED STAINLESS STEEL OR GALVANIZED RODS AND DRILLED EXPANSION ANCHORS DOWN BOTH SIDES OF THE DROP PIPE AT 300mm CENTRE TO CENTRE.
2. DROP PIPE TO BE ONE SIZE SMALLER THAN INCOMING MAIN LINE. DROP PIPE MINIMUM DIAMETER 200mm AND MAXIMUM DIAMETER 450mm.
3. FLEXIBLE SEWER PIPE DROP STRUCTURE CONNECTIONS TO NEW MAINTENANCE HOLES SHALL HAVE FACTORY INSTALLED RESILIENT CONNECTORS IN MAINTENANCE HOLE OPENINGS.
4. FLEXIBLE SEWER PIPE CONNECTIONS TO EXISTING MAINTENANCE HOLES SHALL HAVE RESILIENT WATERSTOPS INSTALLED AND ANNULAR SPACE FILLED WITH PRE-PACKAGED NON-SHRINK GROUT FLUSH WITH EXTERNAL WALLS OF MAINTENANCE HOLES. RESILIENT WATERSTOPS SHALL CONFORM TO ASTM C923.
5. RIGID SEWER PIPE DROP STRUCTURE CONNECTIONS TO MAINTENANCE HOLES SHALL BE MADE WITH A RESILIENT CONNECTOR FOR NEW INSTALLATIONS WHERE PIPE SIZES PERMIT. THE ANNULAR SPACE SHALL BE MORTARED WITH PRE-PACKAGED NON-SHRINK GROUT WHERE A RESILIENT CONNECTOR CANNOT BE INSTALLED OR FOR CONNECTIONS TO EXISTING MAINTENANCE HOLES. PRE-PACKAGED NON-SHRINK GROUT SHALL CONFORM TO ASTM C1107.
6. FOR ITEMS 4 AND 5 ABOVE, WATERPROOFING MEMBRANE SHALL BE INSTALLED AT THE CONNECTION OF THE PIPE TO THE MAINTENANCE HOLE EXTERNAL WALL. THE WATERPROOFING MEMBRANE SHALL EXTEND 0.3M BEYOND THE POINT OF CONNECTION AROUND THE PIPE AND ON THE MAINTENANCE HOLE EXTERNAL WALL.
7. MAINTENANCE HOLES LOCATED WITHIN AREAS SUSCEPTIBLE TO HIGH GROUND WATER OR FLOOD PLAINS SHALL HAVE WATERPROOFING MEMBRANES INSTALLED AT ALL SECTION JOINTS OR WHEN SPECIFIED, THE ENTIRE MAINTENANCE HOLE PER STD I&I-104.
8. OVERFLOW PIPE TO PROTRUDE SUFFICIENTLY BEYOND THE MAINTENANCE HOLE INTERNAL WALL FACE TO FACILITATE FULL INSERTION OF DUCK BILL CHECK VALVE.
9. PRE-CAST DROP STRUCTURES INTEGRAL WITH MAINTENANCE HOLE RISER SECTIONS ARE PERMITTED. WATERPROOFING MEMBRANE SHALL BE INSTALLED PER ITEM 6.
10. BENCHING DETAILS REFER TO OPSD 701.021

MAINTENANCE HOLE
DROP STRUCTURE
TYPE A

DRAWN-BY

DATE 10-29-21

STANDARD NO. I&I-107A

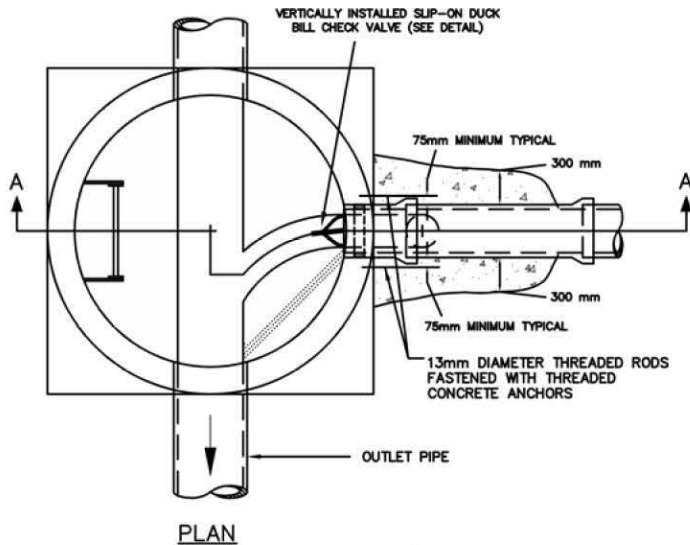

PLAN

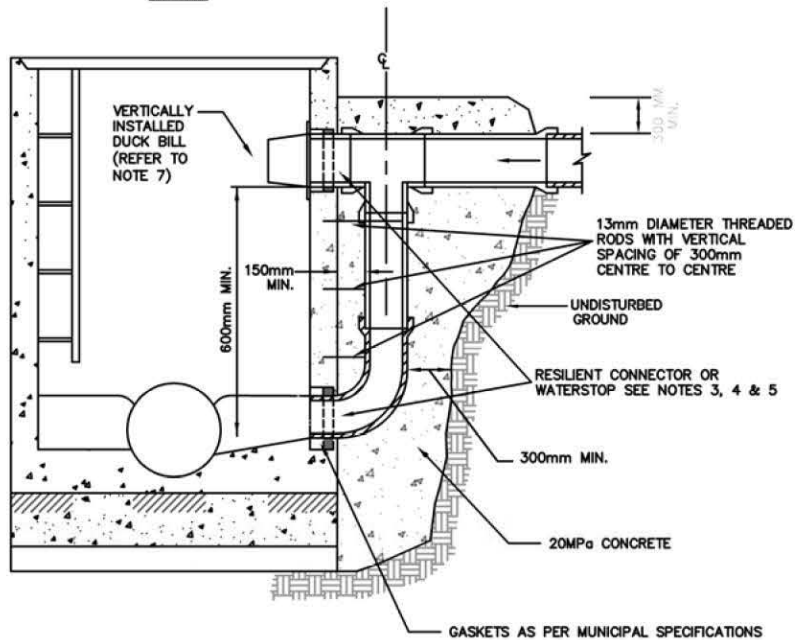

SECTION A-A

NOT TO SCALE

DETAIL

SLIP-ON DUCK BILL CHECK VALVE

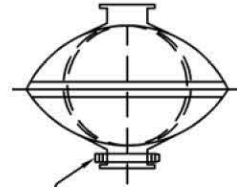

304 STAINLESS STEEL PIPE CLAMPS

FRONT VIEW

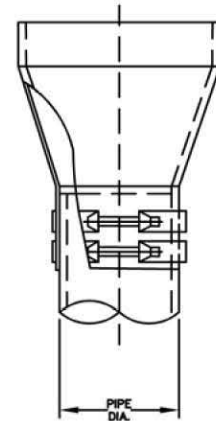

SIDE VIEW

NOTES:

1. DROP STRUCTURE TO BE COMPLETELY ENCASED IN 300mm OF 20MPa CONCRETE AND SECURED TO THE MAINTENANCE HOLE WITH 450mm LONG, 13mm ϕ THREADED RODS AND DRILLED EXPANSION ANCHORS DOWN BOTH SIDES OF THE DROP PIPE AT 300mm CENTRE TO CENTRE.
2. DROP PIPE TO BE ONE SIZE SMALLER THAN INCOMING MAIN LINE. DROP PIPE MINIMUM DIAMETER 200mm AND MAXIMUM DIAMETER 450mm.
3. FLEXIBLE SEWER PIPE DROP STRUCTURE CONNECTIONS TO NEW MAINTENANCE HOLES SHALL HAVE FACTORY INSTALLED RESILIENT CONNECTORS IN MAINTENANCE HOLE OPENINGS.
4. FLEXIBLE SEWER PIPE CONNECTIONS TO EXISTING MAINTENANCE HOLES SHALL HAVE RESILIENT WATERSTOPS INSTALLED AND ANNULAR SPACE FILLED WITH PRE-PACKAGED NON-SHRINK GROUT FLUSH WITH EXTERNAL WALLS OF MAINTENANCE HOLES. RESILIENT WATERSTOPS SHALL CONFORM TO ASTM C923.
5. RIGID SEWER PIPE DROP STRUCTURE CONNECTIONS TO MAINTENANCE HOLES SHALL BE MADE WITH A RESILIENT CONNECTOR FOR NEW INSTALLATIONS WHERE PIPE SIZES PERMIT. THE ANNULAR SPACE SHALL BE MORTARED WITH PRE-PACKAGED NON-SHRINK GROUT WHERE A RESILIENT CONNECTOR CANNOT BE INSTALLED OR FOR CONNECTIONS TO EXISTING MAINTENANCE HOLES. PRE-PACKAGED NON-SHRINK GROUT SHALL CONFORM TO ASTM C1107.
6. FOR ITEMS 4 AND 5 ABOVE, WATERPROOFING MEMBRANE SHALL BE INSTALLED AT THE CONNECTION OF THE PIPE TO THE MAINTENANCE HOLE EXTERNAL WALL. THE WATERPROOFING MEMBRANE SHALL EXTEND 0.3M BEYOND THE POINT OF CONNECTION AROUND THE PIPE AND ON THE MAINTENANCE HOLE EXTERNAL WALL.
7. MAINTENANCE HOLES LOCATED WITHIN AREAS SUSCEPTIBLE TO HIGH GROUND WATER OR FLOOD PLAINS SHALL HAVE WATERPROOFING MEMBRANES INSTALLED AT ALL SECTION JOINTS OR WHEN SPECIFIED, THE ENTIRE MAINTENANCE HOLE PER STD I&I-104.
8. OVERFLOW PIPE TO PROTRUDE SUFFICIENTLY BEYOND THE MAINTENANCE HOLE INTERNAL WALL FACE TO FACILITATE FULL INSERTION OF DUCK BILL CHECK VALVE.
9. PRE-CAST DROP STRUCTURES INTEGRAL WITH MAINTENANCE HOLE RISER SECTIONS ARE PERMITTED. WATERPROOFING MEMBRANE SHALL BE INSTALLED PER ITEM 6.
10. BENCHING DETAILS REFER TO OPSD 701.021

MAINTENANCE HOLE
DROP STRUCTURE
TYPE B

DRAWN-BY

DATE 10-29-21

STANDARD NO. I&I-107B

LEGEND

O.D. = OUTSIDE DIAMETER OF PIPE
 LF = LOAD FACTOR
 AS = AREA OF STEEL

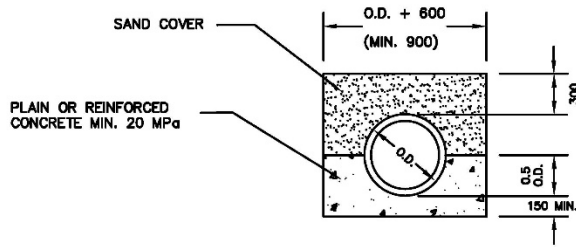

CONCRETE CRADLE

REINFORCED CONCRETE PIPE AND CONCRETE PRESSURE PIPE

CLASS A

REINFORCED AS = 1.0% LF = 4.8
 REINFORCED AS = 1.0% LF = 3.4
 PLAIN LF = 2.8

NOT TO SCALE

*REFER TO NOTE 7 BELOW

LEGEND

O.D. = OUTSIDE DIAMETER OF PIPE
 LF = LOAD FACTOR

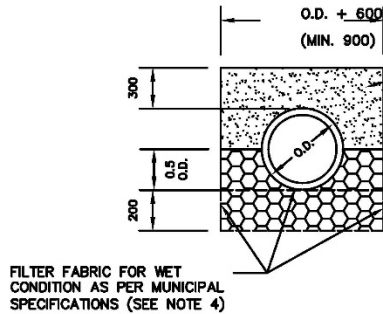

SAND COVER

DRY TRENCH:

- GRANULAR 'A' CONFORMING TO OPSS 1010 OR 19mm CRUSHER RUN LIMESTONE CONFORMING TO OPSS GRANULAR 'A' SPECIFICATION TABLE 2, OR, BLEND OF 426 CRUSH CLEAR & STONE CONFORMING TO CSA 56-14 TABLE 7.9

WET TRENCH:

- 19mm TYPICAL CLEAR LIMESTONE CONFORMING TO OPSS 1004, 100% CRUSHED

FILTER FABRIC FOR WET CONDITION AS PER MUNICIPAL SPECIFICATIONS (SEE NOTE 4)

CLASS B

REINFORCED CONCRETE PIPE AND CONCRETE PRESSURE PIPE

LF = 1.9

NOT TO SCALE

LEGEND

O.D. = OUTSIDE DIAMETER OF PIPE

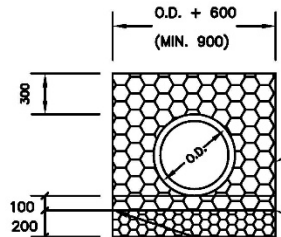

DRY TRENCH:

- GRANULAR 'A' CONFORMING TO OPSS 1010 OR 19mm CRUSHER RUN LIMESTONE CONFORMING TO OPSS GRANULAR 'A' SPECIFICATION TABLE 2, OR, BLEND OF 426 CRUSH CLEAR & STONE CONFORMING TO CSA 56-14 TABLE 7.9

WET TRENCH:

- 19mm TYPE 2 CLEAR LIMESTONE CONFORMING TO OPSS 1004, 100% CRUSHED WRAPPED IN FILTER FABRIC (SEE NOTE 4)

CLASS P

POLYVINYL CHLORIDE PIPE

NOT TO SCALE

NOTES:

- BEDDING MATERIALS SHALL BE FULLY EXTENDED AND COMPACTED AGAINST TRENCH WALLS AND UNDER PIPE HAUNCHES. BEDDING MATERIALS SHALL BE PLACED AND COMPACTED IN 150 mm LAYERS
- NO MECHANICAL COMPACTION EQUIPMENT SHALL BE USED ON TOP OF PIPE PRIOR TO PLACING A MINIMUM 300 mm DEPTH OF COVER
- PIPE SHALL BE BEDDED TO PROPOSED LINE AND GRADE WITH UNIFORM AND CONTINUOUS SUPPORT FROM BEDDING. BLOCKING WITH ANY HARD OBJECT SHALL NOT BE USED TO BRING THE PIPE TO GRADE
- GEOTEXTILE TO CONFORM TO OPS.MUNI. 1860 CLASS 1 AND SHALL BE USED TO WRAP CRUSHED CLEARSTONE BEDDING IF GROUND WATER TABLE IS ABOVE THE TRENCH BED OR IF GROUND WATER IS FLOWING INTO TRENCH THROUGH THE EMBEDMENT ZONE
- BEDDING PER GEOTECHNICAL ENGINEER'S RECOMMENDATION FOR SATURATED AND/OR LOW LOAD BEARING SUB-GRADE SOILS
- ALL GRANULAR MATERIAL SHALL BE COMPACTED TO 98% MAXIMUM DRY DENSITY STANDARD PROCTOR
- ALL DIMENSIONS IN mm
- CONCRETE CRADLE SHALL BE USED FOR SEWERS INSTALLED WITH SLOPES LESS THAN 0.3% AND ON THE RECOMMENDATION OF A GEOTECHNICAL ENGINEER FOR LOW LOAD BEARING SOILS BELOW THE SEWER

SANITARY SEWER PIPE
 BEDDING AND COVER
 DETAILS

DRAWN-BY

DATE 10-29-21

STANDARD NO. I&I-108

FIGURE 1

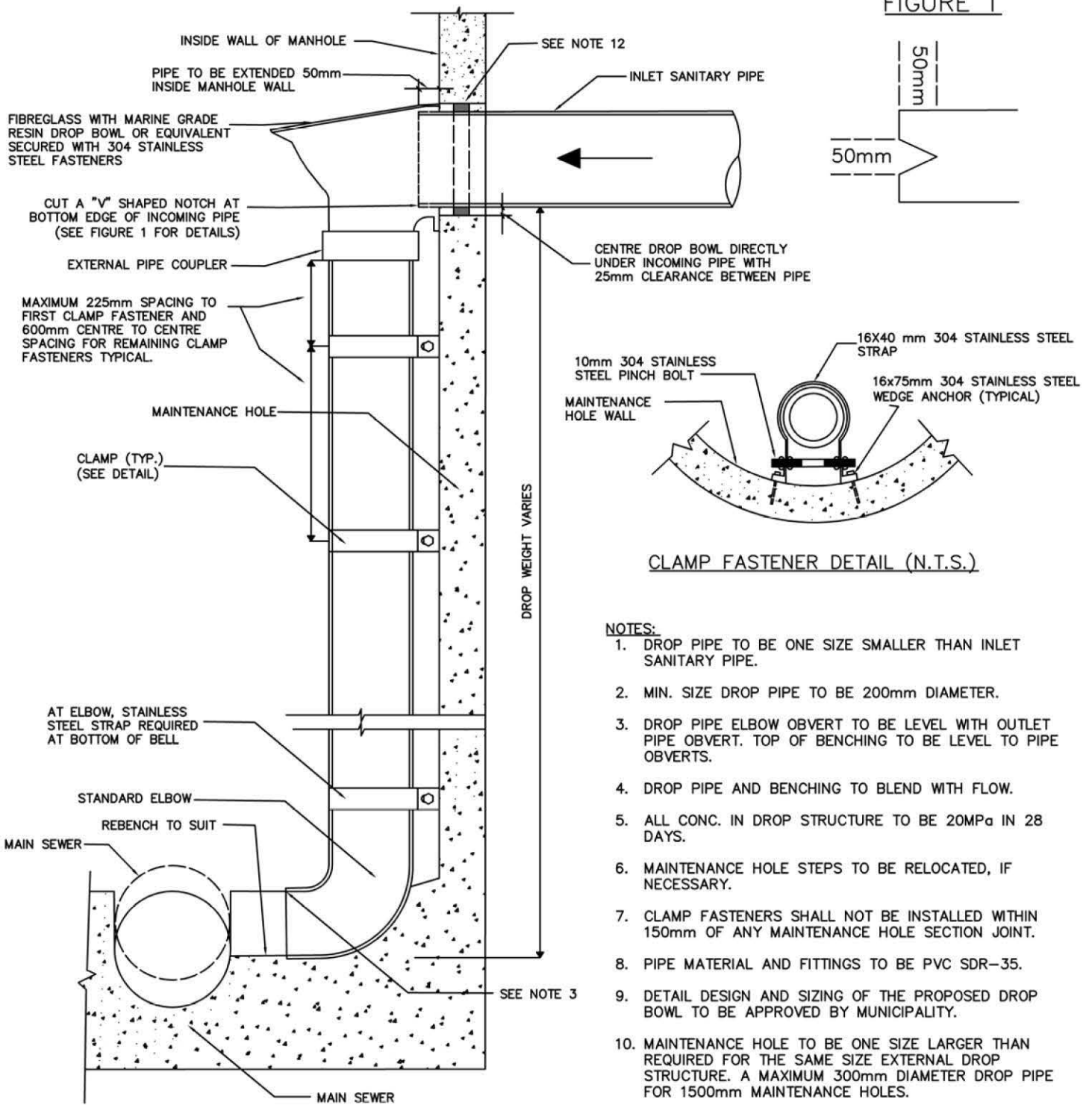

CLAMP FASTENER DETAIL (N.T.S.)

NOTES:

1. DROP PIPE TO BE ONE SIZE SMALLER THAN INLET SANITARY PIPE.
2. MIN. SIZE DROP PIPE TO BE 200mm DIAMETER.
3. DROP PIPE ELBOW OBVERT TO BE LEVEL WITH OUTLET PIPE OBVERT. TOP OF BENCHING TO BE LEVEL TO PIPE OBVERTS.
4. DROP PIPE AND BENCHING TO BLEND WITH FLOW.
5. ALL CONC. IN DROP STRUCTURE TO BE 20MPa IN 28 DAYS.
6. MAINTENANCE HOLE STEPS TO BE RELOCATED, IF NECESSARY.
7. CLAMP FASTENERS SHALL NOT BE INSTALLED WITHIN 150mm OF ANY MAINTENANCE HOLE SECTION JOINT.
8. PIPE MATERIAL AND FITTINGS TO BE PVC SDR-35.
9. DETAIL DESIGN AND SIZING OF THE PROPOSED DROP BOWL TO BE APPROVED BY MUNICIPALITY.
10. MAINTENANCE HOLE TO BE ONE SIZE LARGER THAN REQUIRED FOR THE SAME SIZE EXTERNAL DROP STRUCTURE. A MAXIMUM 300mm DIAMETER DROP PIPE FOR 1500mm MAINTENANCE HOLES.
11. ONLY ONE INTERNAL DROP STRUCTURE PER MAINTENANCE HOLE.
12. REFER TO STANDARDS NO. I&l-106A AND 106B FOR INLET SANITARY SEWER PIPE CONNECTION TO MAINTENANCE HOLE.
13. VORTEX FLOW UNITS SHALL BE INSTALLED FOR DROP HEIGHTS EXCEEDING 5.0m.

NOT TO SCALE

SANITARY MAINTENANCE
HOLE INTERNAL DROP
STRUCTURE

DRAWN-BY

DATE 10-29-21

STANDARD NO. I&l-109

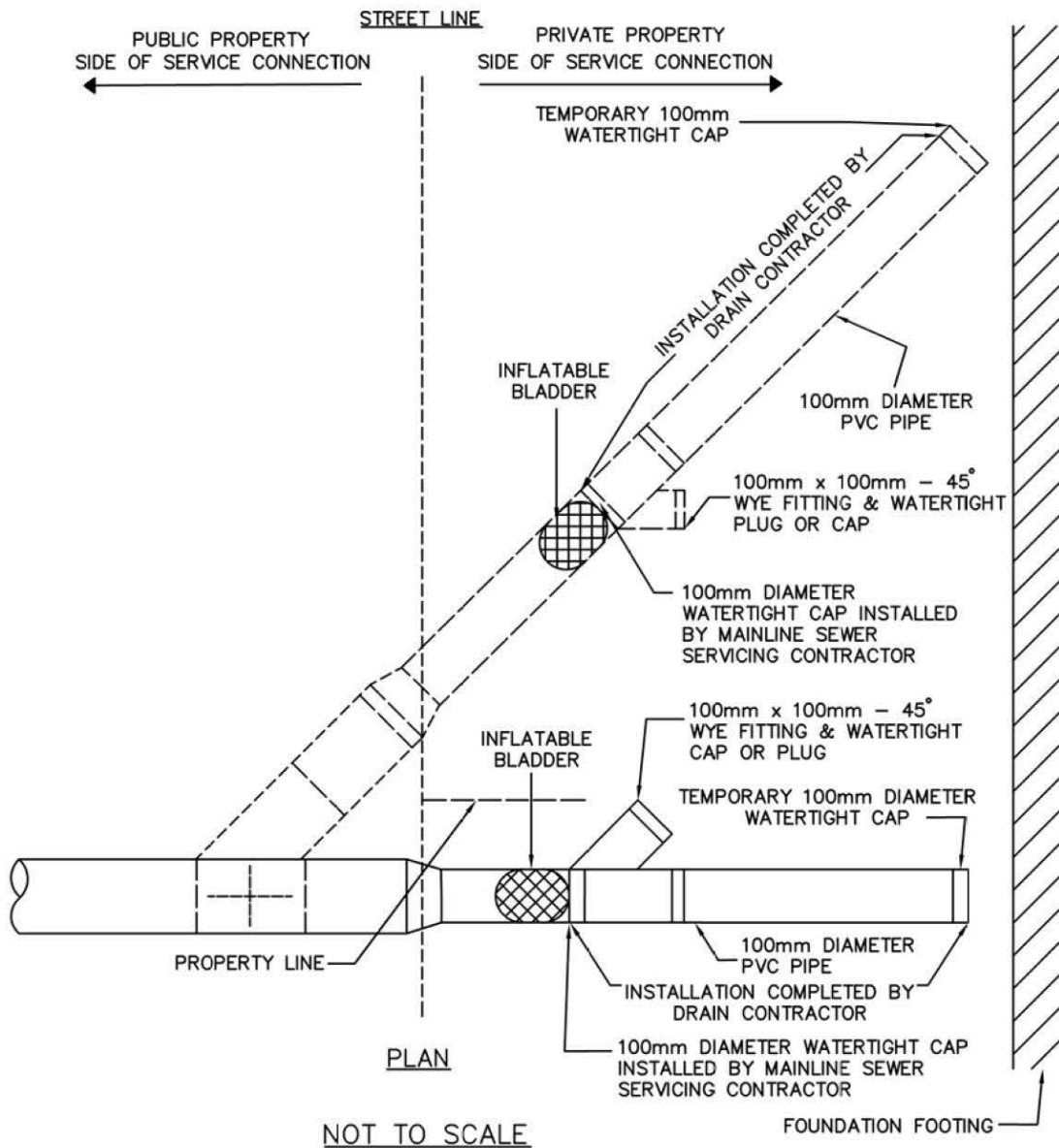

AIR TESTING SEQUENCE:

1. LOCATE AND REMOVE 100mm DIAMETER WATERTIGHT CAP INSTALLED BY MAINLINE SANITARY SEWER SERVICING CONTRACTOR
2. INSTALL 100mm x 100mm - 45° WYE (SOLVENT WELD OR WATERTIGHT GASKET TYPE) AT LOCATION OF CAP INSTALLED BY MAINLINE SANITARY SEWER CONTRACTOR. WYE BRANCH TO HAVE EITHER SOLVENT WELD CAP OR PLUG OR THREADED ADAPTER WITH SCREW IN PLUG
3. INSTALL TEMPORARY 100mm DIAMETER PVC WATERTIGHT CAP ON 100mm PVC SANITARY SEWER CONNECTION IN CLOSE PROXIMITY TO DWELLING FOUNDATION FOOTING OR PLUMBING TERMINUS
4. INSTALL INFLATABLE BLADDER IMMEDIATELY DOWN STREAM OF 100mm x 100mm WYE
5. PERFORM AIR TEST PER REQUIREMENTS AS NOTED IN THE I&I REDUCTION DESIGN AND CONSTRUCTION, INSPECTION AND TESTING STANDARDS
6. REMOVE BLADDER
7. INSTALL WATERTIGHT PLUG/CAP IN WYE BRANCH
8. REMOVE TEMPORARY PLUG TO COMPLETE SANITARY CONNECTION TO DWELLING
9. THE REDUCTION FROM 150mm TO 100mm DIAMETER PIPE ON PRIVATE PROPERTY IS AT THE DISCRETION OF THE LOCAL MUNICIPALITY

NOTES:

1. REFER TO DRAWING I&I-103 FOR SERVICE CONNECTIONS AT PROPERTY LINE

AIR TESTING FOR PRIVATE PROPERTY COMPONENT OF SANITARY SERVICE CONNECTIONS (SINGLE, SEMI RESIDENTIAL DWELLING AND TOWN HOME UNITS)

DRAWN-BY
DATE 10-29-21
STANDARD NO. I&I-110

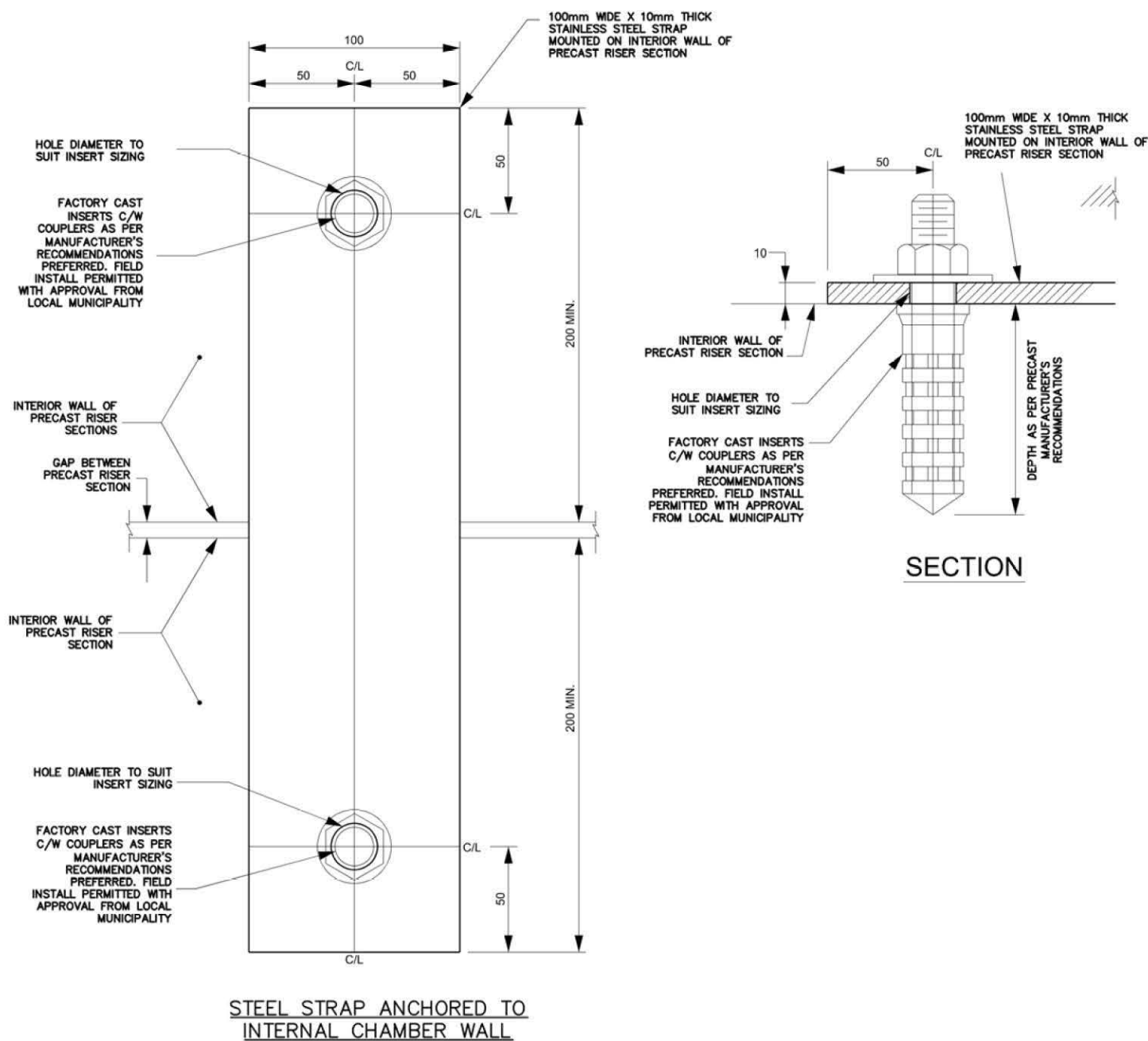

NOT TO SCALE

NOTES:

1. ALL MATERIALS TO BE 304 STAINLESS STEEL
2. FOR REHABILITATION APPLICATION ONLY, INSERTS CAN BE FIELD INSTALLED AS PER MANUFACTURER'S SPECIFICATIONS

TYPICAL STEEL STRAP
DETAILS FOR PRECAST
MAINTENANCE HOLES

DRAWN-BY

DATE 10-29-21

STANDARD NO. |&l|-111